

28 677 670 Produktversion ab 01.04.2025







- Regenbrause Ø 300 mm
- Material Regenbrause: Metall
- PURE RAIN, Durchfluss max. 14 l/min (bei 3 Bar)
- Funktion ab: 10 l/min
- mit Leerlauf-Funktion
- mit Antikalk-System

Technische Daten:

- Ausladung 450 mm
- Rosette 65 x 65 mm
- Anschluss 1/2"

Hinweise:

	Chrom gebürstet	28 677 670-93
	Chrom	28 677 670-00
	Platin gebürstet	28 677 670-06
	Platin	28 677 670-08
	Dark Chrome	28 677 670-19
	Light Gold (PVD)	28 677 670-26
	Light Gold gebürstet (PVD)	28 677 670-27
	Messing gebürstet (23kt Gold)	28 677 670-28
	Schwarz matt	28 677 670-33
	Gold gebürstet (PVD)	28 677 670-37
	Bronze gebürstet (PVD)	28 677 670-42
	Champagne gebürstet (22kt Gold)	28 677 670-46
	Champagne (22kt Gold)	28 677 670-47
	Dark Platin gebürstet	28 677 670-99

Empfohlenes Zubehör

UP-Wandwinkel -

35 085 970 90



- Min. Einbautiefe 90 mm
- Max. Einbautiefe 163 mm

28 677 670 Produktversion ab 01.04.2025

mm [inches]

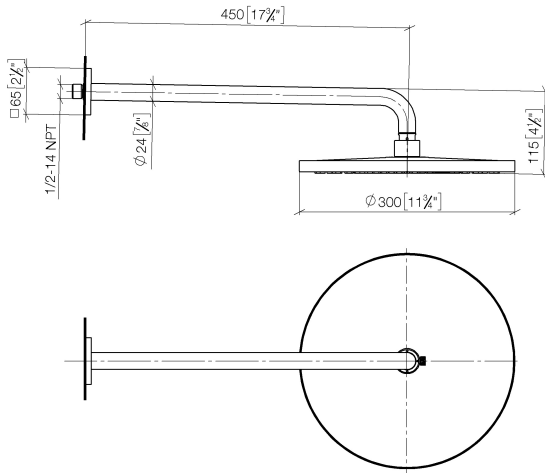

Durchflussdiagramm

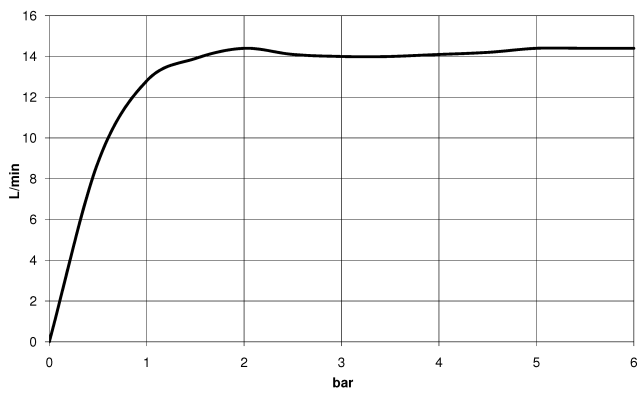

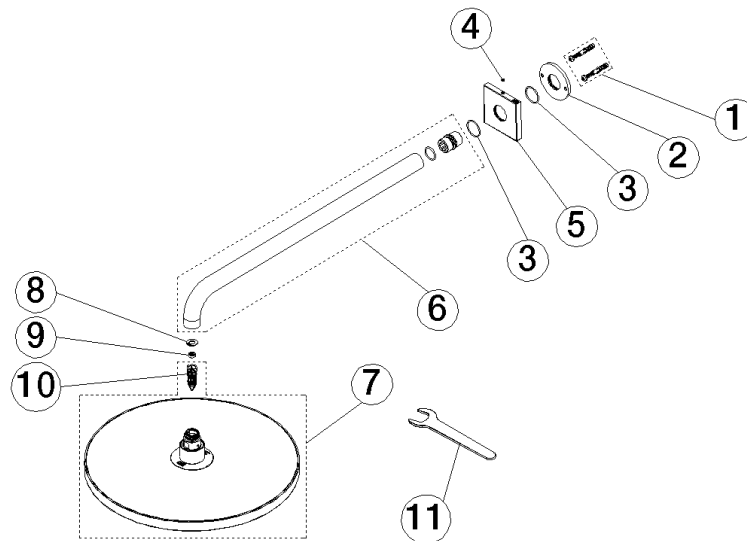

Ersatzteilstückliste

Nr.	Artikelnummer	Benennung	Verbaumenge	Lieferzeit
8	09 16 01 014 90	Ring Sicherungsring Ø 15 x 1 mm -	1,00	2
9	09 23 01 101 90	Durchflussbegrenzer pink 14 l/min. -	1,00	2
2	09 17 20 120 90	Anschluss Ø 56,50 x 5 mm -	1,00	2
10	04 18 40 276 00 90	Rohrbelüfter ohne Durchflussbegrenzer Ø 14 x 37,5 mm, ohne Begrenzung -	1,00	2
3	09 14 10 150 90	O-Ring 23 x 1,5 mm -	2,00	2
7	90 12 05 096 00-93	Regenbrause rund Ø 300 mm - Chrom gebürstet	1,00	20
1	04 30 31 032 00 90	Befestigungssatz Schraube 4 x 35 mm -	1,00	2
6	90 11 03 070 00-93	Rohr 462 x 61 x 24 mm - Chrom gebürstet	1,00	20
4	90 31 11 038 00 90	Befestigung Gewindestift mit Innensechskant mit Ringschneide M4 x 3 mm -	1,00	2
11	90 30 09 069 00 90	Montageschlüssel -	1,00	2
5	09 27 67 015-93	Rosette 65 x 65 x 9 mm - Chrom gebürstet	1,00	20