

Data Sheet | Item Number: 2734-1103/327-000/333-000

1-conductor female connector; lever; Push-in CAGE CLAMP®; 1.5 mm²; Pin spacing 3.5 mm; 3-pole; 100% protected against mismatching; Strain relief plate; 1,50 mm²; light gray



<https://www.wago.com/2734-1103/327-000/333-000>



Color: ■ light gray

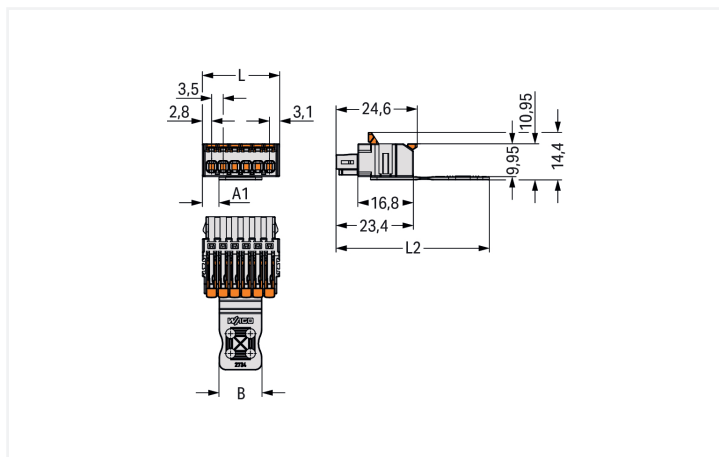

Dimensions in mm

Pole No.	A1	B	L	L2
2	1.55	6	9.4	44.4
3	1.55	9.5	12.9	45.4
4	1.55	13	16.4	46.4
5	5.05	13	19.9	46.4
6	5.05	13	23.4	46.4
7	8.55	13	26.9	46.4
8	1.55	27	30.4	49.4
10	5.05	27	37.4	49.4
12	1.55	41	44.4	54.4
16	8.55	41	58.4	54.4

Dimensions in mm

Female connector, 2734 Series, with 3.5 mm pin spacing

This female connector (item number 2734-1103/327-000/333-000) simplifies electrical installations. Strip lengths must be between 9 and 10 mm when connecting conductors to this female connector. This product features one conductor terminal and utilizes Push-in CAGE CLAMP®. Push-in CAGE CLAMP® connection technology is ideal for connecting all conductor types. It allows direct insertion of both solid and fine-stranded conductors with ferrules without needing to use any tools—all thanks to its pluggable design. Dimensions: (12.9 x 14.4 x 45.4) mm (width x height x depth). This female connector is suitable for conductor cross sections ranging from 0.14 mm² to 1.5 mm².

The contact surface is coated with tin. You can secure connected conductors using the strain relief plate to make cables easier to handle..

Notes	
Safety Information	The MCS – MULTI CONNECTION SYSTEM includes connectors without breaking capacity in accordance with DIN EN 61984. When used as intended, these connectors must not be connected/disconnected when live or under load. When used as intended, these connectors must not be connected/disconnected when live or under load. The circuit design should ensure header pins, which can be touched, are not live when unmated.
Variants:	Other pole numbers Other versions (or variants) can be requested from WAGO Sales or configured at https://configurator.wago.com/ .

Electrical data						
Ratings per	IEC/EN 60664-1			Approvals per	UL 1059	
Overvoltage category	III	III	II	Use group	B	C D
Pollution degree	3	2	2	Rated voltage	300 V	- 300 V
Nominal voltage	160 V	160 V	320 V	Rated current	10 A	- 10 A
Rated impulse withstand voltage	2.5 kV	2.5 kV	2.5 kV			
Rated current	10 A	10 A	10 A			

Approvals per	CSA		
Use group	B	C	D
Rated voltage	300 V	-	300 V
Rated current	10 A	-	10 A

Connection Data

Clamping units	3
Total number of potentials	3
Number of connection types	1
Number of levels	1

Connection 1

Connection technology	Push-in CAGE CLAMP®
Actuation type	Lever
Solid conductor	0.14 ... 1.5 mm ² / 26 ... 14 AWG
Solid conductor; push-in termination	0.34 ... 1.5 mm ² / 22 ... 14 AWG
Fine-stranded conductor	0.14 ... 1.5 mm ² / 26 ... 14 AWG
Fine-stranded conductor; with insulated ferrule	0.14 ... 0.75 mm ²
Fine-stranded conductor; with uninsulated ferrule	0.14 ... 1 mm ²
Strip length	9 ... 10 mm / 0.35 ... 0.39 inches
Pole number	3
Conductor entry direction to mating direction	0°

Physical data

Pin spacing	3.5 mm / 0.138 inches
Width	12.9 mm / 0.508 inches
Height	14.4 mm / 0.567 inches
Depth	45.4 mm / 1.787 inches

Mechanical data

Variable coding	Yes
Anti-rotation protection	Yes

Plug-in connection

Contact type (pluggable connector)	Female connector/socket
Connector (connection type)	for conductor
Mismating protection	Yes
Strain relief	Strain relief plate

Material data

Note (material data)	Information on material specifications can be found here
Color	light gray
Material group	I
Insulation material (main housing)	Polyamide (PA66)
Flammability class per UL94	V0
Clamping spring material	Chrome-nickel spring steel (CrNi)
Contact material	Copper alloy
Contact Plating	Tin
Fire load	0.059 MJ
Weight	3 g

Environmental requirements

Limit temperature range	-60 ... +100 °C
Processing temperature	-35 ... +60 °C

Commercial data

PU (SPU)	50 pcs
Packaging type	Box
Country of origin	DE
GTIN	4066966310771
Customs tariff number	85366990990

Product Classification

UNSPSC	39121409
ETIM 9.0	EC002638
ETIM 10.0	EC002638
ECCN	NO US CLASSIFICATION

Environmental Product Compliance

RoHS Compliance Status	Compliant, No Exemption
------------------------	-------------------------

Downloads

Environmental Product Compliance

Compliance Search	↓
-------------------	-------------------

Documentation

Additional Information			
Technical Section	03.04.2019	pdf 2027.26 KB	↓

CAD/CAE-Data

CAD data	↓
----------	-------------------

1 Compatible Products

1.1 System counterpart

1.1.1 Male connector/plug

<p>Item No.: 734-303 1-conductor male connector; CAGE CLAMP®; 1.5 mm²; Pin spacing 3.5 mm; 3-pole; 100% protected against mismatching; 1,50 mm²; light gray</p>	<p>Item No.: 734-163 THT male header; 1.0 x 1.0 mm solder pin; angled; 100% protected against mismatching; Pin spacing 3.5 mm; 3-pole; light gray</p>	<p>Item No.: 734-133 THT male header; 1.0 x 1.0 mm solder pin; straight; 100% protected against mismatching; Pin spacing 3.5 mm; 3-pole; light gray</p>
--	--	--

1.2 Optional Accessories

1.2.1 Coding





1.2.1.1 Coding



<p>Item No.: 2734-505 Coding pin carrier; 5 coding keys; for female connectors; orange</p>

1.2.2 Ferrule

1.2.2.1 Ferrule

 <p>Item No.: 216-241 Ferrule; Sleeve for 0.5 mm² / 20 AWG; insulated; electro-tin plated; electrolytic copper; gastight crimped; acc. to DIN 46228, Part 4/09.90; white</p>	 <p>Item No.: 216-141 Ferrule; Sleeve for 0.5 mm² / 20 AWG; un-insulated; electro-tin plated; electrolytic copper; gastight crimped; acc. to DIN 46228, Part 1/08.92</p>	 <p>Item No.: 216-242 Ferrule; Sleeve for 0.75 mm² / 18 AWG; insulated; electro-tin plated; electrolytic copper; gastight crimped; acc. to DIN 46228, Part 4/09.90; gray</p>	 <p>Item No.: 216-262 Ferrule; Sleeve for 0.75 mm² / 18 AWG; insulated; electro-tin plated; electrolytic copper; gastight crimped; acc. to DIN 46228, Part 4/09.90; gray</p>
 <p>Item No.: 216-142 Ferrule; Sleeve for 0.75 mm² / 18 AWG; un-insulated; electro-tin plated; electrolytic copper; gastight crimped; acc. to DIN 46228, Part 1/08.92</p>			

1.2.3 Jumper

1.2.3.1 Jumper



<p>Item No.: 2734-402 Jumper; for conductor entry; 2-way; insulated; light gray</p>
--

1.2.4 Locking system

1.2.4.1 Locking system



Item No.: 2734-510

Locking lever; for female connectors; 1 part; For Push-in CAGE CLAMP® connection; lever; orange

1.2.5 Test and measurement

1.2.5.1 Testing accessories



Item No.: 735-500

WAGO Test pin; 1 mm Ø; 30 V AC / 60 V DC; CAT0; 1 A; 6 mm uninsulated; Test lead for soldering up to 0,5mm²

Installation Notes

Conductor termination

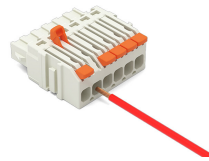
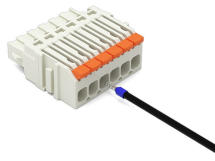
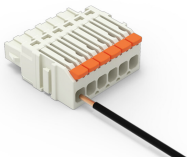

Conductor removal

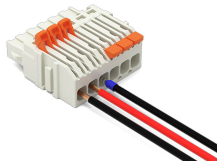

Testing

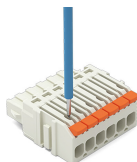
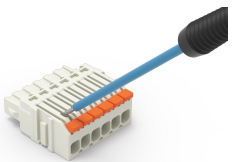

Marking

