

Cepex inbouwcontactdoos, grijs

Bestelnr. 4210



- schroefklemmen
- tevens geschikt voor wandgoot en energiezuilen
- slagvast volgens DIN 18032

Technische informatie

Ampère	16 A
Polen	3 p
Voltage	230 V
Uurstand	6 h
Hertz	50-60 Hz
Beschermingsgraad	IP 44
Aanrakingsveiligheid	false
Gewicht	185 g
Certificeringen	VDE, EAC

Tekeningen

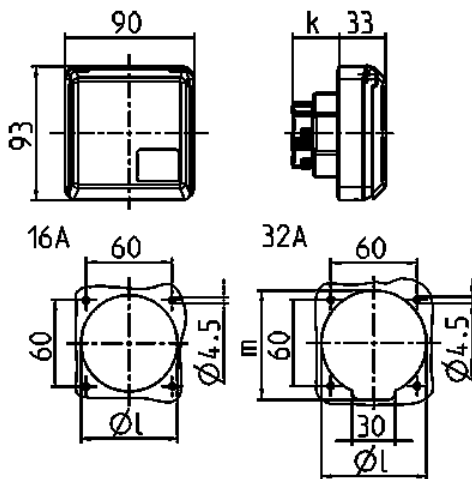

Tekening	Amp. Polen	16			32		
		3	4	5	3	4	5
1 MB 315							
Maten in mm	k	32	32	32	48	48	48
	l	55	60	67	65	65	73
	m	-	-	-	70	70	76
Kabelaansluiting		1,5	1,5	1,5	2,5	2,5	2,5
van/tot mm²		—4	—4	—4	—6	—6	—6