

Data Sheet | Item Number: 2734-1107/038-000

1-conductor female connector; lever; Push-in CAGE CLAMP®; 1.5 mm²; Pin spacing 3.5 mm; 7-pole; 100% protected against mismatching; Lateral locking levers; 1,50 mm²; light gray



<https://www.wago.com/2734-1107/038-000>



Color: ■ light gray

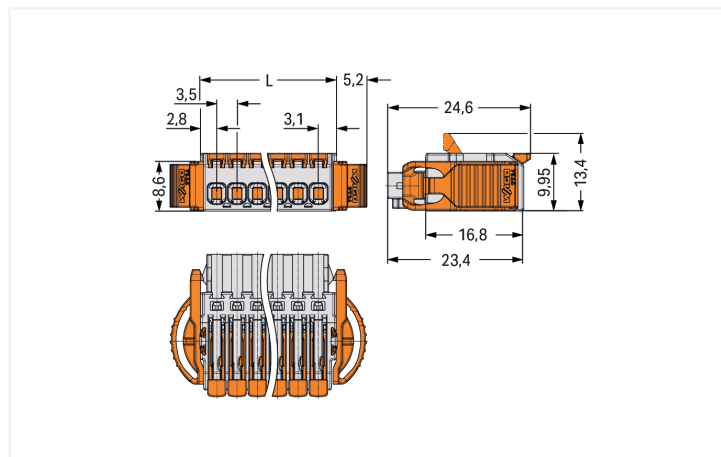
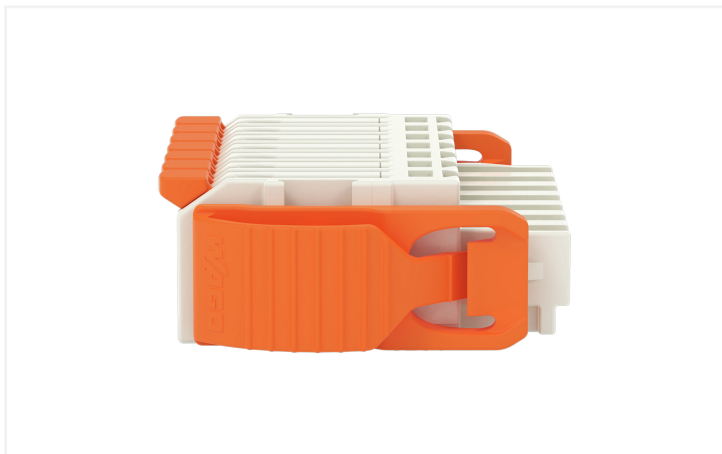

$$L = (\text{pole no.} \times \text{pin spacing}) + 2.4 \text{ mm}$$

Female connector, 2734 Series, with 3.5 mm pin spacing

Error-free electrical installations are guaranteed with this female connector (item number 2734-1107/038-000). Ensure that the strip lengths are between 9 and 10 mm when connecting conductors to this female connector. Featuring one conductor terminal along with Push-in CAGE CLAMP®, this



connector delivers reliable performance. Push-in CAGE CLAMP® technology provides a universal connection solution for all conductor types. It allows both solid and fine-stranded conductors with ferrules to be inserted directly into the clamping point without the need for tools. Dimensions: (37.3 x 13.5 x 24.6) mm (width x height x depth). This female connector is suitable for conductor cross sections ranging from 0.14 mm² to 1.5 mm².

Tin is used for coating the contact surfaces.

Notes	
Safety Information	The MCS – MULTI CONNECTION SYSTEM includes connectors without breaking capacity in accordance with DIN EN 61984. When used as intended, these connectors must not be connected/disconnected when live or under load. When used as intended, these connectors must not be connected/disconnected when live or under load. The circuit design should ensure header pins, which can be touched, are not live when unmated.
Variants:	Other pole numbers Other versions (or variants) can be requested from WAGO Sales or configured at https://configurator.wago.com/ .

Electrical data							
Ratings per	IEC/EN 60664-1			Approvals per	UL 1059		
Overvoltage category	III	III	II	Use group	B	C	D
Pollution degree	3	2	2	Rated voltage	300 V	-	300 V
Nominal voltage	160 V	160 V	320 V	Rated current	10 A	-	10 A
Rated impulse withstand voltage	2.5 kV	2.5 kV	2.5 kV				
Rated current	10 A	10 A	10 A				
Approvals per	CSA						
Use group	B	C	D				
Rated voltage	300 V	-	300 V				
Rated current	10 A	-	10 A				

Connection Data		Connection 1	
Clamping units	7	Connection technology	Push-in CAGE CLAMP®
Total number of potentials	7	Actuation type	Lever
Number of connection types	1	Solid conductor	0.14 ... 1.5 mm ² / 26 ... 14 AWG
Number of levels	1	Solid conductor; push-in termination	0.34 ... 1.5 mm ² / 22 ... 14 AWG
		Fine-stranded conductor	0.14 ... 1.5 mm ² / 26 ... 14 AWG
		Fine-stranded conductor; with insulated ferrule	0.14 ... 0.75 mm ²
		Fine-stranded conductor; with uninsulated ferrule	0.14 ... 1 mm ²
		Strip length	9 ... 10 mm / 0.35 ... 0.39 inches
		Pole number	7
		Conductor entry direction to mating direction	0°

Physical data

Pin spacing	3.5 mm / 0.138 inches
Width	37.3 mm / 1.469 inches
Height	13.5 mm / 0.531 inches
Depth	24.6 mm / 0.969 inches

Mechanical data

Variable coding	Yes
Anti-rotation protection	Yes

Plug-in connection

Contact type (pluggable connector)	Female connector/socket
Connector (connection type)	for conductor
Mismating protection	Yes
Locking of plug-in connection	Lateral locking lever

Material data

Note (material data)	Information on material specifications can be found here
Color	light gray
Material group	I
Insulation material (main housing)	Polyamide (PA66)
Flammability class per UL94	V0
Clamping spring material	Chrome-nickel spring steel (CrNi)
Contact material	Copper alloy
Contact Plating	Tin
Fire load	0.197 MJ
Weight	6.6 g

Environmental requirements

Limit temperature range	-60 ... +100 °C
Processing temperature	-35 ... +60 °C

Commercial data

PU (SPU)	50 pcs
Packaging type	Box
Country of origin	DE
GTIN	4066966355383
Customs tariff number	85366990990

Product Classification

UNSPSC	39121409
ETIM 9.0	EC002638
ETIM 10.0	EC002638
ECCN	NO US CLASSIFICATION

Environmental Product Compliance

RoHS Compliance Status	Compliant, No Exemption
------------------------	-------------------------

Downloads

Environmental Product Compliance

Compliance Search	
Environmental Product Compliance 2734-1107/038-000	↓

Documentation

Additional Information			
Technical Section	03.04.2019	pdf 2027.26 KB	↓

CAD/CAE-Data

CAD data	
2D/3D Models 2734-1107/038-000	↓

PCB Design	
Symbol and Footprint via SamacSys 2734-1107/038-000	↓
Symbol and Footprint via Ultra Librarian 2734-1107/038-000	↓

1 Compatible Products

1.1 System counterpart

1.1.1 Male connector/plug

<p>Item No.: 734-307 1-conductor male connector; CAGE CLAMP®; 1.5 mm²; Pin spacing 3.5 mm; 7-pole; 100% protected against mismatching; 1,50 mm²; light gray</p>	<p>Item No.: 734-167 THT male header; 1.0 x 1.0 mm solder pin; angled; 100% protected against mismatching; Pin spacing 3.5 mm; 7-pole; light gray</p>	<p>Item No.: 734-137 THT male header; 1.0 x 1.0 mm solder pin; straight; 100% protected against mismatching; Pin spacing 3.5 mm; 7-pole; light gray</p>

1.2 Optional Accessories

1.2.1 Coding

1.2.1.1 Coding

<p>Item No.: 2734-505 Coding pin carrier; 5 coding keys; for female connectors; orange</p>

1.2.2 Ferrule

1.2.2.1 Ferrule



Item No.: 216-241

Ferrule; Sleeve for 0.5 mm² / 20 AWG; insulated; electro-tin plated; electrolytic copper; gastight crimped; acc. to DIN 46228, Part 4/09.90; white



Item No.: 216-141

Ferrule; Sleeve for 0.5 mm² / 20 AWG; un-insulated; electro-tin plated; electrolytic copper; gastight crimped; acc. to DIN 46228, Part 1/08.92



Item No.: 216-242

Ferrule; Sleeve for 0.75 mm² / 18 AWG; insulated; electro-tin plated; electrolytic copper; gastight crimped; acc. to DIN 46228, Part 4/09.90; gray



Item No.: 216-262

Ferrule; Sleeve for 0.75 mm² / 18 AWG; insulated; electro-tin plated; electrolytic copper; gastight crimped; acc. to DIN 46228, Part 4/09.90; gray



Item No.: 216-142

Ferrule; Sleeve for 0.75 mm² / 18 AWG; un-insulated; electro-tin plated; electrolytic copper; gastight crimped; acc. to DIN 46228, Part 1/08.92

1.2.3 Jumper

1.2.3.1 Jumper



Item No.: 2734-402

Jumper; for conductor entry; 2-way; insulated; light gray

1.2.4 Strain relief

1.2.4.1 Strain relief plate



Item No.: 2734-534

Strain relief plate; for female connectors; 13 mm wide; 1 part; lever; Pin spacing 3.5 mm; light gray

1.2.5 Test and measurement

1.2.5.1 Testing accessories



Item No.: 735-500

WAGO Test pin; 1 mm Ø; 30 V AC / 60 V DC; CAT0; 1 A; 6 mm uninsulated; Test lead for soldering up to 0,5mm²

Installation Notes

Conductor termination

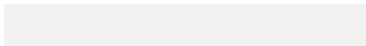
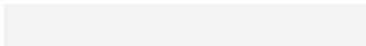
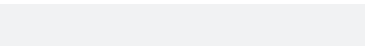
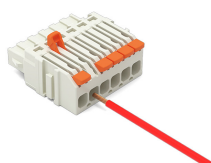
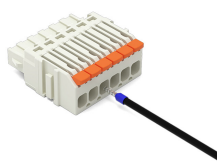
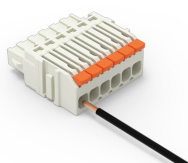

Conductor removal

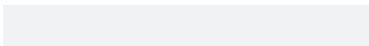
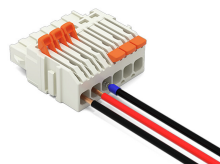

Testing

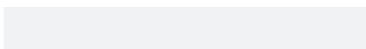
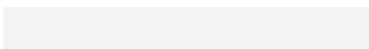
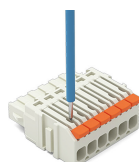
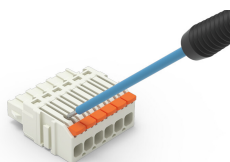

Marking

