

Maxi Accu - MA Heat/Cool

600-1000-2000-3000-5000-10000 l.

EN



SAFETY INFORMATION
O&M INFORMATION
INSTALLATION MANUAL



OSO

HOT WATER

CONTENTS

1. Safety instructions	3
1.1 General information	3
1.2 Safety instructions for users	4
1.3 Safety instructions for installers.....	4
2. Product description	5
2.1. Product identification	5
2.2. Intended use.....	5
2.3 CE marking	5
2.4 Technical data	5
3. Installation instructions	6
3.1. Products covered by these instructions	6
3.2. Included in delivery	6
3.3. Product dimensions.....	6
3.4. Requirements for installation location .	7
3.5. Pipe installation.....	8
4. Initial commissioning	10
4.1. Filling with water.....	10
4.2. Control points	10
4.4. Emptying of water	10
4.5. Handover to end-user.....	10
5. User guide	10
5.1. Settings.....	10
6. Troubleshooting	10
6.1. Faults and fixes.....	10
7. Warranty conditions	11
7.1. Warranty and registration	11
7.2. Customer service.....	11
8. Removing the product	11
8.1. Removal	11
8.2. Returns scheme	11

1. SAFETY INSTRUCTIONS

1.1 General information



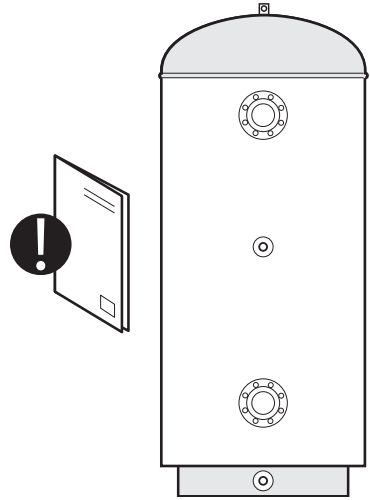

- Read the following safety instructions carefully before installing, maintaining or adjusting the buffer tank.
- Personal injury or material damage may result if the product is not installed or used in the intended manner.
- Keep this manual and other relevant documents where they are accessible for future reference.
- The manufacturer assumes compliance (by the end-user) with the safety, operating and maintenance instructions supplied and (by the installer) with the fitting manual and relevant standards and regulations in effect at the date of installation.





Symbols used in this manual:





	WARNING	Could cause serious injury or death
	CAUTION	Could cause minor or moderate injury or damage to property
	DO NOT	
	DO	





1.2 Safety instructions for users

 WARNING	
	The safety valve overflow shall NOT be sealed or plugged.
	The product shall NOT be modified or changed from its original state.
	Children shall NOT play with the product or go near it without supervision.
	Maintenance/settings shall only be carried out by persons over 18 years of age, with sufficient understanding

 CAUTION	
	The product shall not be exposed to frost, over-pressure, over-voltage or chlorine treatment. See warranty provisions.
	Maintenance/settings shall not be carried out by persons of diminished physical or mental capacity, unless they have been instructed in the correct use by someone responsible for their safety.

1.3 Safety instructions for installers

 WARNING	
	The safety valve overflow shall NOT be sealed or plugged.
	Any overflow pipe from the safety valve MUST be ≥ 18 mm inside, clear, undamaged and frost-free with a fall to the drain.
	The relevant regulations and standards, and this installation manual, must be followed.

 CAUTION	
	The product shall be placed in a room with a floor drain. The manufacturer assumes no responsibility whatsoever if this provision is not followed.
	The product shall be properly aligned vertically and horizontally, on a floor or wall suitable for the total weight of the product when in operation. See type plate.
	The product must have a clearance for servicing of 40 cm in front of front / 10 cm over the highest point.

2. PRODUCT DESCRIPTION

2.1 Product identification

Identification details for your product can be found on the type plate fixed to the product. The type plate contains details of the product in accordance with EN 12897:2016 as well as other useful data. See Declaration of Conformity at www.osohotwater.com for more information.

OSO products are designed and manufactured in accordance with:

- Pressurised Equipment Directive PED2014/68/EU
- Welding standard EN ISO 3834-2

OSO Hotwater AS is certified for

- Quality ISO 9001
- Environment ISO 14001
- Work environment ISO 45001

2.4 Technical data

NRF no.	OSO product no.	Product code:	Capacity, persons	Weight, kg.	Diameter x height (mm)	Freight vol. m ³	Actual vol. l.
800 1373	11003351	MA 600 Heat	-	152	ø 800x2030	1,28	583
800 1354	11003345	MA 1000 Heat	-	238	ø1000x2100	2,29	885
800 1356	11003198	MA 2000 Heat	-	362	ø1300x2440	4,25	-
800 1357	11003199	MA 3000 Heat	-	566	ø1500x2695	6,25	-
800 1358	11003200	MA 5000 Heat	-	930	ø1700x3180	9,45	-
800 1363	11003201	MA 10000 Heat	-	1770	ø2000x4400	17,95	-
800 1273	11003344	MA 600 Cool	-	152	ø 695x2030	1,28	583
800 1254	11003338	MA 1000 Cool	-	238	ø 840x2100	2,29	885
800 1256	11003189	MA 2000 Cool	-	362	ø1140x2440	4,25	-
800 1257	11003190	MA 3000 Cool	-	566	ø1340x2695	6,25	-
800 1258	11003191	MA 5000 Cool	-	930	ø1540x3180	9,45	-
800 1263	11003192	MA 10000 Cool	-	1770	ø1840x4400	17,95	-

Regulation: 2017/1369/EU - Regulation: EU 812/2013 Directive: 2009/125/EC - Regulation: EU 814/2013

Heat loss tested acc. to standard: EN 12897: 2015

2.2 Intended use

The Maxi Accu Heat is designed for use as a buffer tank for heat-pumps/solar collectors.

The Maxi Accu Coolis designed for use as a cooler tank in cooling systems etc.

The product is designed for use in a closed circuit system.

2.3 UKCA marking

**UK
CA**

The UKCA mark shows that the product complies with the relevant Directives. See Declaration of Conformity at www.osohotwater.co.uk for more information.

The safety valve(s) used must be CE marked and conform to PED 2014/68/EU.

3. INSTALLATION INSTRUCTIONS

3.1 Products covered by these instructions

Maxi Accu MA 600 Heat
 Maxi Accu MA 1000 Heat
 Maxi Accu MA 2000 Heat
 Maxi Accu MA 3000 Heat
 Maxi Accu MA 5000 Heat
 Maxi Accu MA 10000 Heat
 Maxi Accu MA 600 Cool
 Maxi Accu MA 1000 Cool
 Maxi Accu MA 2000 Cool
 Maxi Accu MA 3000 Cool
 Maxi Accu MA 5000 Cool
 Maxi Accu MA 10000 Cool

3.2 Included in delivery

Ref no.	Number of	Description
1	1	Buffer tank without electric backup
2	1	Installation manual (this document)
3	1	Safety valve 3 bar

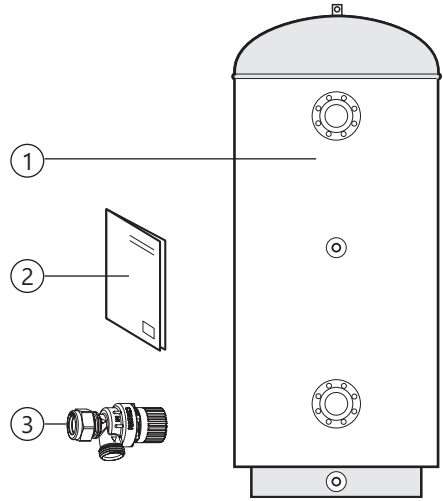

3.3 Product dimensions

All dimensions in mm.

Product.	A	B	C	D	Ø HEAT	Ø COOL
MA 600	2030	1555	335		800	695
MA 1000	2100	1600	390		1000	840
MA 2000	2440	1885	475		1300	1140
MA 3000	2695	2090	530		1500	1340
MA 5000	3180	2490	625		1700	1540
MA 10000	4400	3635	705		2000	1840

Tolerance +/- 10 mm.

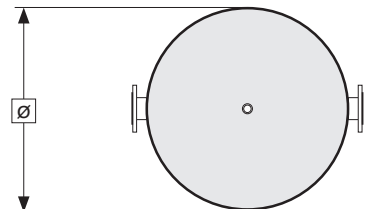
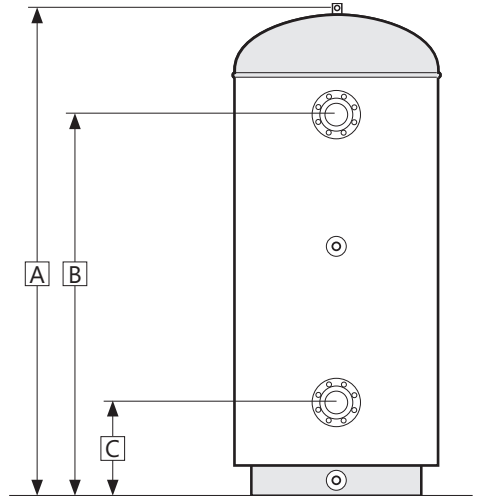

3.3.1 Delivery

The product should be transported carefully, with packaging on. Lifting lug (L) must be used when lifting the product.

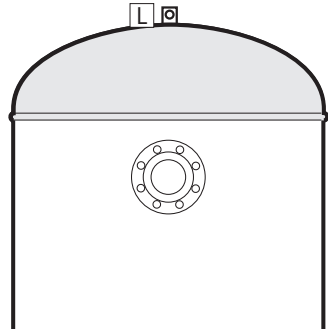

⚠ CAUTION

Pipe stubs, valves etc. should not be used to lift the product as this could cause malfunctions.

3.4 Requirements for installation location and positioning

⚠ CAUTION

- | | |
|---|---|
| ❗ | The product shall be placed in a room with a floor drain.
The manufacturer assumes no responsibility whatsoever if this provision is not followed. |
| ❗ | The product shall be placed in a dry and permanently frost-free position. |
| ❗ | The product shall be placed on a floor or wall suitable for the total weight of the product when in operation. See type plate. |
| ❗ | The product must have a clearance for servicing of 40 cm in front of front / 10 cm over the highest point. |
| ❗ | The product shall be easily accessible for servicing and maintenance. |

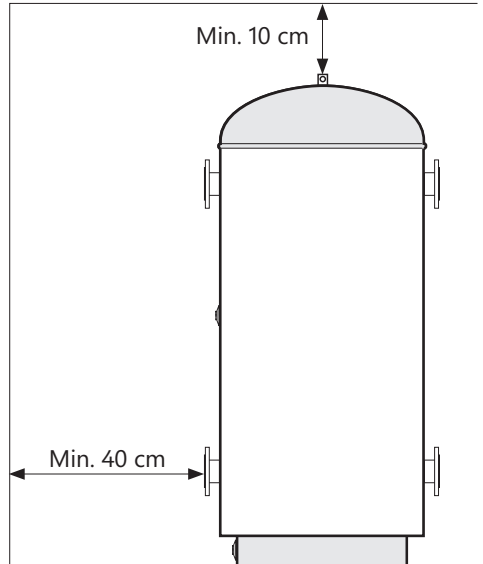
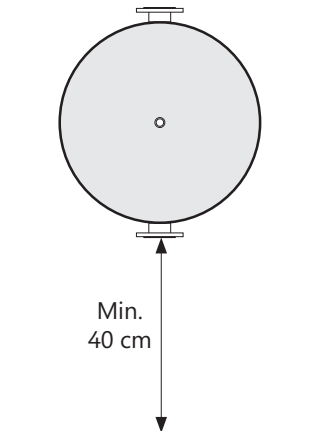

3.5 Pipe installation

Approved pipes of the correct size should be used for installation. The relevant standards and regulations must be followed.

No.	Dimension	Connection description
1	3/4" female	Venting
2	DN 80 PN 10	2 x Return (600 l.)
2	DN 100 PN 10	2 x Return (1000 l.)
2	To order	Return (2000-10 000 l.)
3	1/2" female	Safety valve / thermometer
4	DN 80 PN 10	2 x Return (600 l.)
4	DN 100 PN 10	2 x Return (1000 l.)
4	To order	Return (2000-10 000 l.)
5	1" male	Drain

3.5.1 Incoming water pressure

The product is designed for a max. operating pressure of 6 bar.

3.5.2 Fitting pipes

A) Run a pipe of suitable size to the connections shown, and affix with suitable sealant. Unused connections must be plugged securely.

3.5.3 Safety valve

The supplied SV-381 safety valve is dimensioned for 10kW effect. It shall be fitted in connection (3) by removing the nut and olive (6) from the valve, then inserting the exposed 1/2" thread into connection (3).

Ensure that your installation has sufficient dimensioning of safety equipment in accordance with PED 2014/68 / EU.

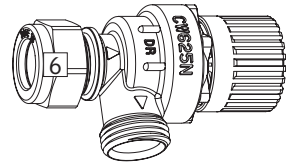
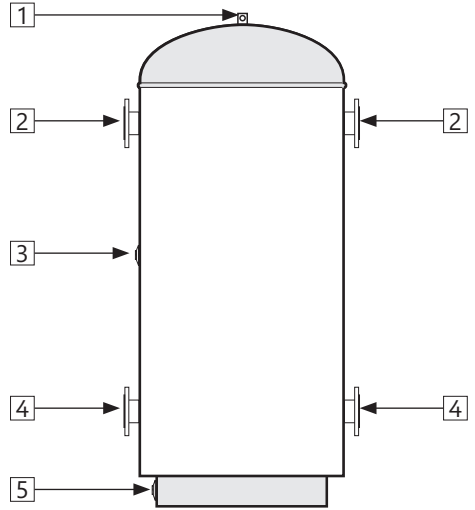

3.5.4 Fitting instructions

⚠ CAUTION	
❗	The product shall be placed in a room with a floor drain. The manufacturer assumes no responsibility whatsoever if this provision is not followed.
❗	The product shall be properly aligned vertically and horizontally, on a floor suitable for the total weight of the product when in operation. See type plate.
❗	The product must have a clearance for servicing of 40 cm in front of front / 10 cm over the highest point.

3.5.5 Fitting recommendation

RECOMMENDATION	
-	If the maximum water pressure exceeds 6 bar in a 24-hour period, a reduction valve and expansion vessel shall be fitted.

4. INITIAL COMMISSIONING

4.1 Filling with water

First check that all pipes are connected correctly. Then proceed as follows:

- A) Open for venting at a point in the system higher than the top of the tank; use e.g. the 3/4" top connection on the product.
- B) Open the water supply to the product. When water flows out of the venting point, the tank is full and the vent can be sealed.

4.2 Control points

- A) Check that all pipe connections to/from the product are tight and not leaking.
- B) Check that the product is standing firmly vertically and horizontally.

4.3 Emptying of water

⚠ WARNING

The water temperature in the product may exceed 75°C and could cause scalding. Use caution when emptying the product.

- A) Shut off/disconnect heat source.
- B) Close the incoming water supply.
- C) Open a hot water tap or venting connection (prevents vacuum).
- D) The product is emptied by opening the drain plug (2). The product empties.
- E) After emptying, close the drain plug and any venting before the product is refilled.

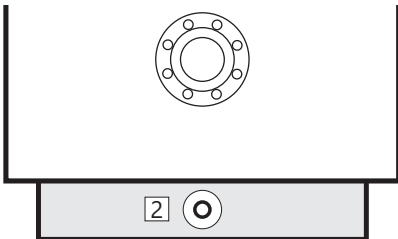

4.4 Handover to end-user

THE INSTALLER MUST:

- | |
|--|
| Brief the end-user on safety and maintenance instructions. |
| Brief the end-user on settings and emptying the product. |
| Hand this installation manual over to the end-user. |
| Enter contact details on the type plate on the product. |

5. SETTINGS

5.1 Settings

The product does not require any special settings.

5.2 Maintenance

MAINTENANCE INSTRUCTIONS	
❗	Maintenance should be carried out by persons over 18 years of age, with sufficient understanding.
❗	Annual inspection of safety valve:
-	Open valve for 1 min. by turning knob (1) approx. 90 degrees counterclockwise to the open position.
-	Visually check that the water is flowing freely to the drain.
-	YES = OK. Close the valve by turning knob (1) further counterclockwise.
-	NO = NOT OK. Disconnect power supply / shut off water supply. Contact installer.

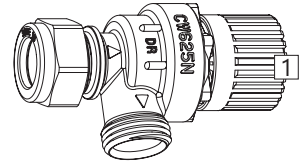

6. TROUBLESHOOTING

6.1 Faults and fixes

If problems arise when the product is in use, check for these possible faults:

1. Water leaking from pipe connection. Possible cause: Pipe connection is loose or sealant is insufficient. Possible solution: Tighten pipe connection, replace sealant if necessary.
2. Water leaking from the tank, not the pipe connection. Possible cause: Leakage from the steel tank. Possible solution: Check if it is possible to see the leak point. Contact installer.

If you are unsure what is wrong, contact the installer (see product type plate) or OSO Hot-water AS - see section 6.1.

7. WARRANTY CONDITIONS - applies to UK only

1. Scope

OSO Hotwater UK Ltd. (hereinafter called OSO) warrants for 2 years from the date of purchase, that the Product will: i) conform to OSO specification, ii) be free from defects in materials and workmanship, subject to conditions below. All components carry a 2-year warranty.

The warranty is voluntarily extended by OSO to 25 years for the stainless steel inner tank. This extended warranty only applies to Products purchased by a consumer, that has been installed for private use and that has been distributed by OSO or by a distributor where the Products have been originally sold by OSO.

The extended warranty does not apply to Products purchased by commercial entities or for Products that have been installed for commercial use. These shall be subject only to the mandatory provisions of the law. The conditions and limitations set out below shall apply.

2. Coverage

If a defect arises and a valid claim is received within the statutory warranty period, at its option and to the extent permitted by law, OSO shall either; i) repair the defect, or; ii) replace the product with a product that is identical or similar in function, or; iii) refund the purchase price.

If a defect arises and a valid claim is received after the statutory warranty period has expired, but within the extended warranty period, OSO will supply a product that is identical or similar in function. OSO will in such cases not cover any other associated costs. In addition, for every year after the statutory warranty period, the claimant must contribute 4 % of the list price of the cylinder in question to OSO.

Any exchanged Product or component will become the legal property of OSO. Any valid claim or service does not extend the original warranty. The replacement Product or part does not carry a new warranty.

3. Conditions

The Product is manufactured to suit most public water supplies. However, there are certain water chemistries (outlined below) that can have a detrimental effect on the Product and its life expectancy. If there are uncertainties regarding water quality, the local water supply authority can supply the necessary data.

The warranty applies only if the conditions set out below are met in full:

- The Product has been installed by a professional installer, in accordance with the instructions in the installation manual and all relevant Codes of Practice and Regulations in force at the time of installation.
- The Product has not been modified in any way, tampered with or subjected to misuse and no factory fitted parts have been removed for unauthorized repair or replacement.
- The Product has only been connected to a domestic mains water supply in compliance with the European Drinking Water Directive EN 98/83 EC, or latest version. The water should not be aggressive, i.e. the water chemistry shall comply with the following:

- Chloride	< 250 mg / L
- Electric Conductivity (EC) @25°C	< 750 uS / cm
- Saturation Index (LSI) @80°C	> - 1,0 / < 0,8

7.1 Customer service

In case of problems that cannot be resolved with the aid of the troubleshooting guide in this installation manual, contact either:

- pH level > 6,0 / < 9,5
- The immersion heater has not been exposed to hardness levels exceeding 5°dH (180 ppm CaCO₃). Warranty is invalid if the product is affected by accumulation of limescale/calcium deposits. A water softener is recommended in such cases.
- Any disinfection has been carried out without affecting the Product in any way whatsoever. The product must be isolated from chemically treated water.
- The Product has been in regular use from the date of installation. If the Product is not intended to be used for 60 days or more, it must be drained.
- The immersion heater element must be removed for inspection on service after 5 years. The threads must be checked for corrosion. If signs of corrosion are evident, the element must be replaced. Subsequently the element must be removed and examined every 3 years. Failure to do so in areas of aggressive water may result in the element separating from the cylinder with consequential escape of water.
- Service and/or repair shall be done according to the installation manual and all relevant codes of practice. Any replacement parts used shall be original OSO spare parts.
- The Service record / Benchmark logbook has been completed and updated after each annual service. Invoices should be kept as proof of service.
- The Commissioning Checklist / Benchmark certificate has been completed at the time of installation.
- Any third-party costs associated with any claim has been authorized in advance by OSO in writing.
- The purchase invoice and/or installation invoice, a water sample as well as the defective product is made available to OSO upon request.

Failure to follow these instructions and conditions may result in product failure, and water escaping from the Product.

4. Limitations

The warranty does not cover:

- Any fault or costs arising from incorrect installation, incorrect application, lack of regular maintenance in accordance with the installation manual, neglect, accidental or malicious damage, misuse, any alteration, tampering or repair carried out by a non-professional, any fault arising from the tampering with or removal of any factory fitted safety components or measures.
- Any consequential damage or any indirect loss caused by any failure or malfunction of the Product whatsoever.
- Any pipework or any equipment connected to the Product.
- The effects of frost, lightning, voltage variation, lack of water, dry boiling, excess pressure or chlorination procedures.
- The effects of stagnant (de-aerated) water if the Product has been left unused for more than 60 days consecutively.
- Damage caused during transportation. Buyer shall give the carrier notice of such damage.
- Costs arising if the Product is not immediately accessible for servicing.

These warranties do not affect the Buyer's statutory rights.

- A) The installer who supplied the product.
- B) OSO Hotwater UK: Phone: (0191) 482 0800
technical.uk@oso-hotwater.com
www.osohotwater.co.uk

8. REMOVING THE PRODUCT

8.1 Removal

- A) Disconnect the power supply.
- B) Shut off incoming cold water supply.
- C) Empty the product of water – see section 4.4.
- D) Disconnect all pipes.
- E) The product can now be removed.

8.2 Returns scheme

This product is recyclable and should be taken to the environmental recycling centre. If the product is to be replaced with a new one, the installer can take the old cylinder away for recycling.

OSO

HOTWATER

OSO Hotwater (UK) Limited

Endeavor House, Seventh Avenue,
Team Valley Trading Estate,
Gateshead,
Tyne & Wear,
NE11 0EF

Phone: (0191) 482 0800 Fax: (0191) 491 3655

E-mail: technical.uk@oso-hotwater.co.uk

E-mail: sales.uk@oso-hotwater.co.uk

Manufactured by

OSO Hotwater AS

Industriveien 1
3300 Hokksund - Norway

Tel.: +47 32 25 00 00

oso@oso.no

www.osohotwater.com