

xComfort LeakageStop CWGE-0U/31



Flush-box mount



CWGE-0U/01

CRAZ-01/01

CWZG-00/01



Acoustic and LED alarm



Normal Open & Normal Close
 Solenoid valves supported



On-device operating
 - Acknowledge alarm
 - Re-open valve
 - Close valve

55 mm frame compatible cover included



Onboard water sensor or with external sensor cable



868.3 MHz

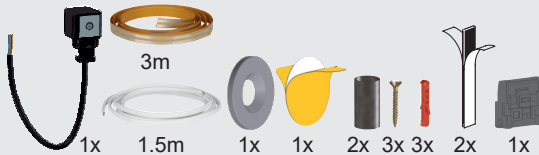

Device	Type	Color
CWGE-0U/31	Universal	Pure white, gloss
CWZG-CM/03	Cover main	Silver, matt
CWZG-CM/09	Cover main	Jet black, matt
CWZG-CS/03	Cover sensor	Silver, matt
CWZG-CS/09	Cover sensor	Jet black, matt

Technical Data / Technische gegevens / Tekniske data / Technische Daten / Technická data

Power supply	230 VAC +10% -15%, 50 Hz
Solenoid Valve Support	
Power supply	230 VAC, 50 Hz max. 100 W
Type	NO and NC
On device settings	
Valve Type	NO (default), NC
LED	Multi-Color operation status
Dimensions	70 x 70 x 39 mm (L x W x D)
RF	868.3 MHz (xComfort compatible)
Max RF power:	25 mW (ERP)
Cable strain relief	
Cable diameter	Ø 4.5-7 mm
Cable type	H05VV-F
Screw torque	0.5 Nm
Important!	Always use, included, isolation tubes on the cable when using the strain relief
Cover screw torque	0.1 Nm

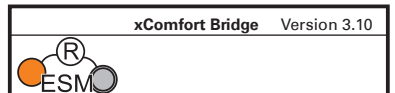
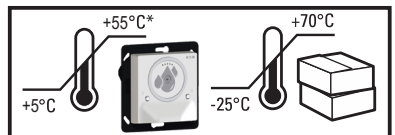

www.eaton.com/LeakageStop

Mounting / Montage / Montering / Montage / Montáž

Important!: For FG approval the xComfort LeakageStop must be installed by an authorized electrician and used with a Danfoss ECO-Brass solenoid valve installed by an authorized plumber

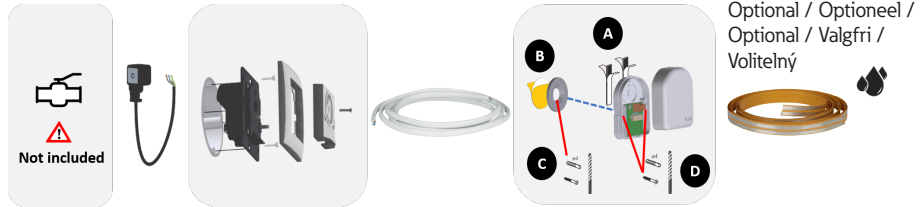

! Solenoid Valve not included / Magneetventiel niet inbegrepen / Magnetventil ikke inkludert / Magnetventil nicht enthalten / Elektromagnetický ventil není součástí dodávky
 Recommended valve: Danfoss ECO-Brass solenoid valve series

55x55mm Frame compatibility

Eaton	Merten	Gira	Busch&Jäger*	Jung	Berker	Siemens	Elko	Kopp
Standard	1-M	Standard 55	Carat	AS	S.1	Delta line	RS16	Alaska
	Atelier M	E2	Solo	A 500	B.1	Delta vita	Plus	
	M-Smart	Event	Future	A Plus	B.3	Delta miro		
	M-Arc	Esprit	Future Linear	A creation	B.7 Glas	Delta miro Glas		
	M-Star	E22	CZ Future					
	M-Plan		Busch-balance SI					
	M-Plan II							
	M-Plan Metall							

On wall wiring / Bedrading op wand / På veggledning / Wandverkabelung, Aufputz / Zapojení na omítce

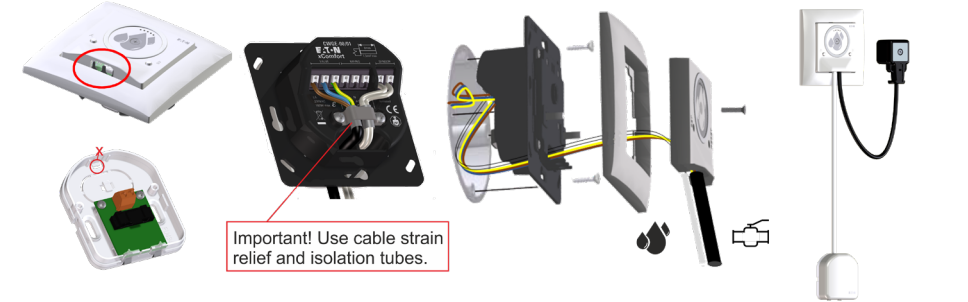

In wall wiring / Bedrading in wand / I veggledning / Wandverkabelung, Unterputz / Zapojení ve zdi

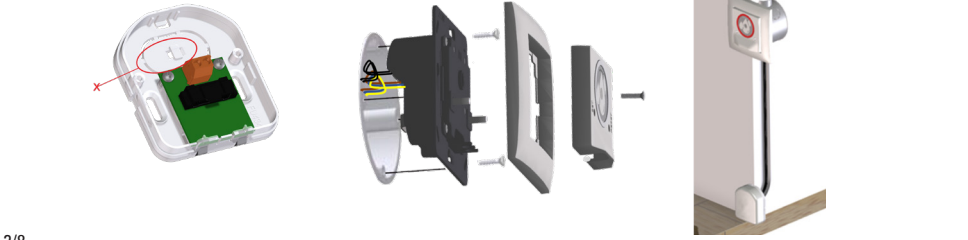

Wiring diagram / Aansluitschema / Koblingskjemaer / Anschlussplan / Schéma zapojení

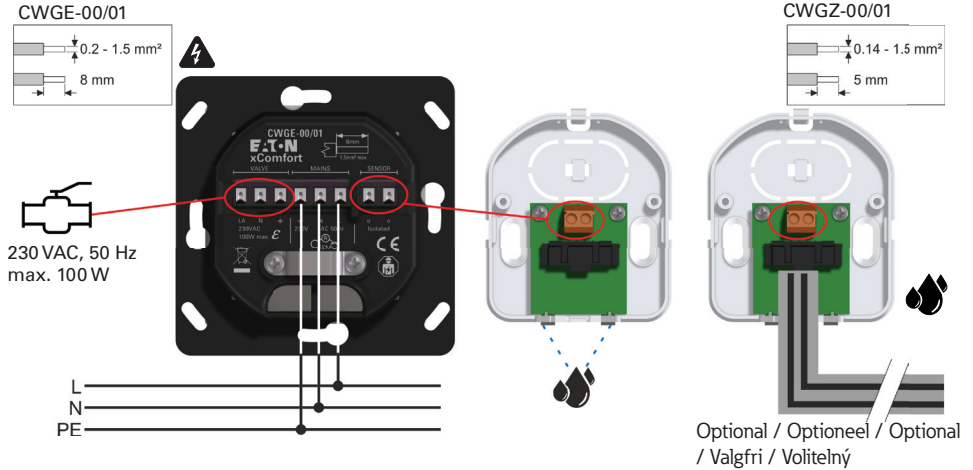

Connect sensor cable / Sensorkabel aansluiten / Koble til sensorkabelen / Sensorkabel anschließen / Připojení kabelu senzoru

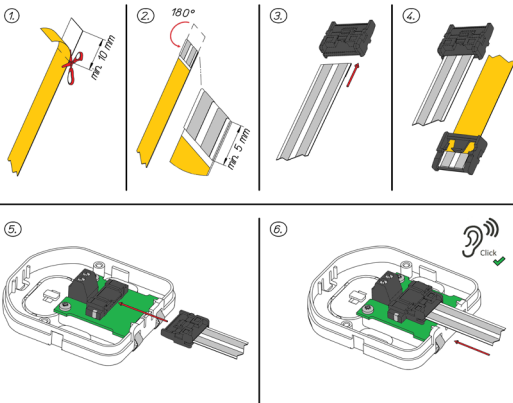

How to apply the sensor cable / Hoe de sensorkabel aan te sluiten / Slik bruker du sensorkabelen / Anbringen des Sensorkabels / Jak instalovat kabel senzoru

- **Surface must be clean, dry and dust-free / Ondergrond moet schoon, droog en stofvrij zijn / Overflaten må være ren, tørr og støvfri / Oberfläche muss sauber, trocken und staubfrei sein / Povrch musí být čistý, suchý a bezprašný**

- **Do not to touch the exposed adhesive area at any time / Raak het blootliggende kleefgedeelte nooit aan / Ikke berør det eksponerte limområdet / Den freiliegenden Klebebereich nicht berühren / Nedotýkejte se odкрыté lepicí plochy**

- **Press firmly / Druk stevig aan / Trykk fast / Fest andrücken / Pevně přitlače**

Remove sensor cable / Sensorkabel verwijderen / Fjern sensorkabelen / Sensorkabel entfernen / Odpojte kabel senzoru

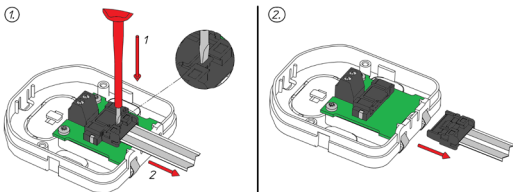

- **Once mounted, the adhesive tape cannot be reused / Eenmaal gemonteerd, kan de tape niet opnieuw worden toegepast / Når den er monteret, kan ikke klebebandet brukes på nytt / Nach der Montage kann das Klebeband nicht wieder verwendet werden / Po namontování nelze lepicí pásku znovu použít**

Positioning / Positionering / Plassering / Positionierung / Umístění

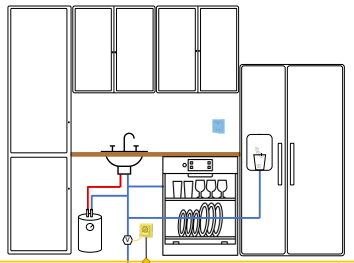

Basic

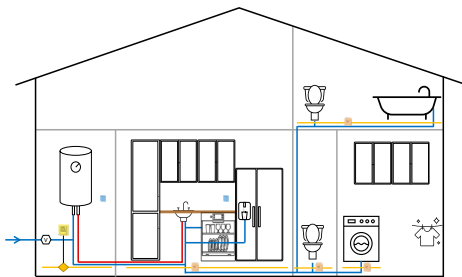

Multiroom

	xComfort Switch with icons (optional) *		Water sensor cable *
	xComfort LeakageStop Universal *		Solenoid valve **
	xComfort LeakageStop Detector *		
* Installed by electrician		** Installed by plumber	

Note: For the Norwegian market the installation of the solution must be according to TEK 17, § 15-5

Basic mode

Note: Options lime scale protection function and control additional switching actuator are not supported in Basic Mode. Find more information about these in xComfort Bridge 'FAQ' or MRF 'Help Topics' . /

Opmerking: Opties kalkbeschermingsfunctie en besturing extra schakelactor worden in de basismodus niet ondersteund. Meer informatie hierover vindt u in xComfort Bridge 'FAQ' of MRF 'Help Topics' . /

Merk: Supplerende funksjoner som ventilosjonering og bruk av bryteaktuatorer for styring av elektriske apparater støttes ikke i Basic Mode, kun via xComfort Bridge og MRF. Finn mer informasjon om dette i xComfort Bridge 'FAQ' eller MRF 'Help Topics' . /

Hinweis: Die Optionen Kalkschutzfunktion und Steuerung zusätzlicher Schaltaktoren werden im Basic Mode nicht unterstützt. Weitere Informationen dazu finden Sie in der xComfort Bridge „FAQ“ oder MRF „Hilfethemen“ . /

Poznámka: Funkce ochrany proti vodnímu kameni a ovládání přídatného spínacího aktuátoru nejsou v základním režimu podporovány. Více informací naleznete v xComfort Bridge 'FAQ' nebo v software MRF 'Help Topics' .

Connect Push-button or LeakageStop Detector / Sluit pulsdrucker of waterdetector aan / Koble til trykknapp eller vanddetektor / Funk-Taster oder Wassersensor verbinden / Spárování tlačítka nebo detektoru zaplavení

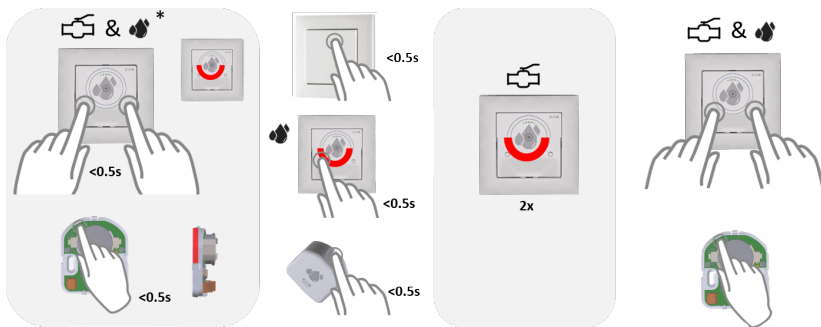

* = Main device, = Detector device

Max. 5 LeakageStop detectors / Max. 5 waterdetektoren / Maks. 5 vanddetektorer / Max. 5 Wassersensoren / Max. 5 detektorů zaplaveno

Remove Push-button or LeakageStop Detector / Verwijder de pulsdrucker of waterdetector / Fjern trykknapp eller vanddetektor / Funk-Taster oder Wassersensor trennen / Odpárování tlačítka nebo detektoru zaplavení

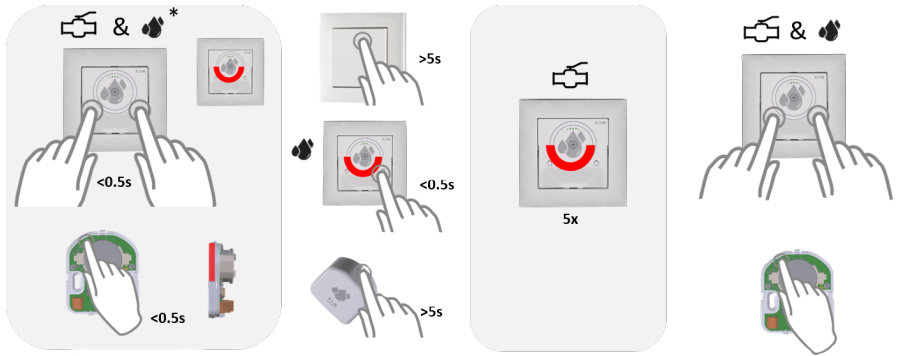

* = Main device, = Detector device

Configure Valve type / Type klep configureren / Konfigurer ventiltype / Ventiltyp konfigurieren / Volba typu ventilu

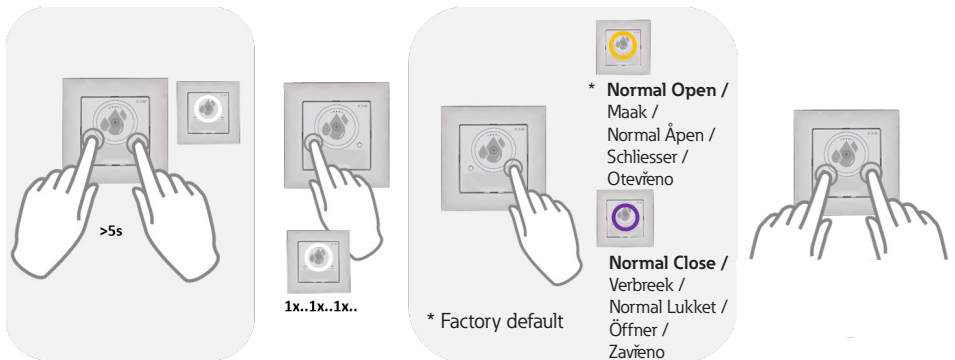

Back to factory default / Terug naar fabrieksinstellingen / Tilbake til fabrikkinnstilling / Zurück zu den Werkseinstellungen / Výrobní nastavení

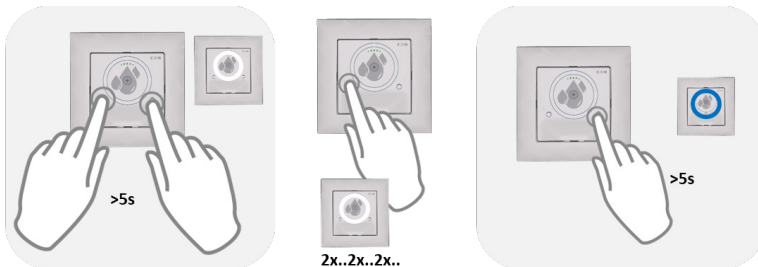

LED during operation / LED tijdens bedrijf / LED under drift / LED im Normalbetrieb / LED během provozu



	X	X	X	
	X	X		X
		X		
				X
				X



No RF communication / Geen RF-communicatie / Inge RF-kommunikasjon / Keine Funk-Kommunikation / Žádná RF komunikace



Over temperature protection. Check load / Te hoge temperatuur bescherming. Controleer belasting / Overtemperaturbeskyttelse utløst. Vennligst sjekk lasten! / Übertemperaturschutz. Last prüfen / Ochrana proti přehřátí. Zkontrolujte zatížení

Quick User Guide /

Beknopte gebruikershandleiding /

Hurtigveiledning /

Schnellanleitung /

Stručný návod k obsluze

xComfort LeakageStop



What to do if water is detected:

1		Reset the sound alert by briefly (<0.5s) pressing button B .	
2		Check for water leakage. Make sure that the installation site is dry and in order.	
3		Open the water valve by pressing button A for more than 3s.	

Manual control of the water valve:

	Close the water valve by pressing button B for more than 3s.	
	Open the water valve by pressing button A for more than 3s.	

Important! For insurance approval this form needs to be filled in. / Viktig! For forsikringsgodkjenning må dette skjemaet fylles ut.



For installer (For installatør)

A: Electrician (Elektriker)

Company / fitter (Foretak/montør)

Installation date (Installasjonsdato)

B: Plumber (Rørlegger)

Company / fitter (Foretak/montør)

Installation date (Installasjonsdato)

Installed products (Installerte produkter)*

A / B	Art.nr. (NRF-/El-nr.)	TG-Nr.	FG-nr.	Description (Beskrivelse)
<input type="checkbox"/> <input type="checkbox"/>				
<input type="checkbox"/> <input type="checkbox"/>				
<input type="checkbox"/> <input type="checkbox"/>				
<input type="checkbox"/> <input type="checkbox"/>				

* Must be installed by an authorized installer. (Må installeres av autorisert installatør.)

Yes (Ja) No (Nei)

- | | | |
|--------------------------|--------------------------|--|
| <input type="checkbox"/> | <input type="checkbox"/> | Are the products assembled according to the manufacturer's instructions? (Er produktene montert i henhold til produsentens anvisninger?) |
| <input type="checkbox"/> | <input type="checkbox"/> | Does the system shut off the water as intended? (Stenger systemet vannet som forutsatt?) |
| <input type="checkbox"/> | <input type="checkbox"/> | Has the coverage area for TEK 17 been taken care of? (Er dekningsområdet til TEK 17 ivare tatt?) |
| <input type="checkbox"/> | <input type="checkbox"/> | Are the products function tested after installation and do they work as intended? (Er produktene funksjonstestet etter montering og virker som forutsatt?) |

For customer/owner/user (For kunde/eier/bruker)

Customer/owner/user
(Kunde/eier/bruker)

Installation address, zip code / place (Installasjonsadresse,
postnr./sted)

G.nr./B.nr

Insurance company (Forsikringselskap)

Yes (Ja) No (Nei)

- | | | |
|--------------------------|--------------------------|---|
| <input type="checkbox"/> | <input type="checkbox"/> | Has the customer / owner / user received training and received the necessary documentation? (Har kunde/eier/bruker fått opplæring og mottatt nødvendig dokumentasjon?) |
| <input type="checkbox"/> | <input type="checkbox"/> | Is the customer / owner aware that the system must be maintained in accordance with the manufacturer's instructions? (Er kunde/eier klar over at systemet skal vedlikeholdes i henhold til produsentens anvisninger?) |

The form is filled in by the installers and owner / user. The owner / user is responsible for submitting the form to their insurance company. (Skjemaet fylles ut av installatører og eier/bruker. Eier/bruker er ansvarlig for å sende inn skjemaet til sitt forsikringselskap.)

Place/Date
(Sted/Dato)

Signature/stamp installer
(Signatur/stempel installatør)

Signature owner/user
(Signatur eier/bruker)



Declaration of Conformity

We, EATON Industries (Austria) GmbH
3943 Schrems, Eugenia 1
Austria

declare under our sole responsibility as manufacturer that the product (family)

Eaton - LeakageStop UP

CWGE-00/01

(the declaration of conformity applies to all listed types within our actual product catalogue)

provided that it is installed, maintained and used in the application intended for, with respect to the relevant manufacturer's instructions, installation standards and "good engineering practices"

complies with the provisions of Council directive(s):

RED Directive 2014/53/EU

RoHS Directive 2011/65/EU + 2015/863

based on compliance with following standard(s):

EN 300220-2 V3.2.1, EN 301 489-1 V2.2.3, EN 301489-3 V2.1.1,
EN IEC 63044-5-1:2019, EN IEC 63044-5-2:2019, EN IEC 63044-5-3:2019, EN 60669-2-5:2016, EN 63000:2018



Schrems, 11.11.2021

Gerhard Dischner

Director Operations

Friedrich Schröder

Director Quality

Doc.Id.: CWGE_00-01_111121

