

28 647 670 Produktversion ab 01.04.2025











- Regenbrause Ø 220 mm
- Material Regenbrause: Metall
- PURE RAIN, Durchfluss max. 9 l/min (bei 3 Bar)
- Funktion ab: 8 l/min
- mit Leerlauf-Funktion
- mit Antikalk-System

Technische Daten:

- Ausladung 450 mm
- Rosette 65 x 65 mm
- Anschluss 1/2"

Hinweise:

	Bronze gebürstet (PVD)	28 647 670-42
	Chrom	28 647 670-00
	Platin gebürstet	28 647 670-06
	Platin	28 647 670-08
	Dark Chrome	28 647 670-19
	Light Gold gebürstet (PVD)	28 647 670-27
	Messing gebürstet (23kt Gold)	28 647 670-28
	Schwarz matt	28 647 670-33
	Gold gebürstet (PVD)	28 647 670-37
	Champagne gebürstet (22kt Gold)	28 647 670-46
	Champagne (22kt Gold)	28 647 670-47
	Chrom gebürstet	28 647 670-93
	Dark Platinum gebürstet	28 647 670-99

Empfohlenes Zubehör

UP-Wandwinkel - 35 085 970 90

- Min. Einbautiefe 90 mm
- Max. Einbautiefe 163 mm



28 647 670 Produktversion ab 01.04.2025

mm [inches]

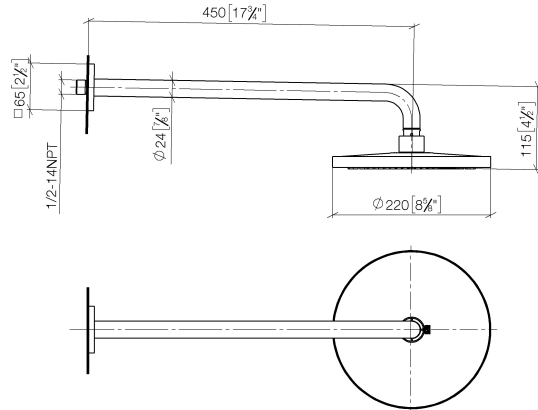

Durchflussdiagramm



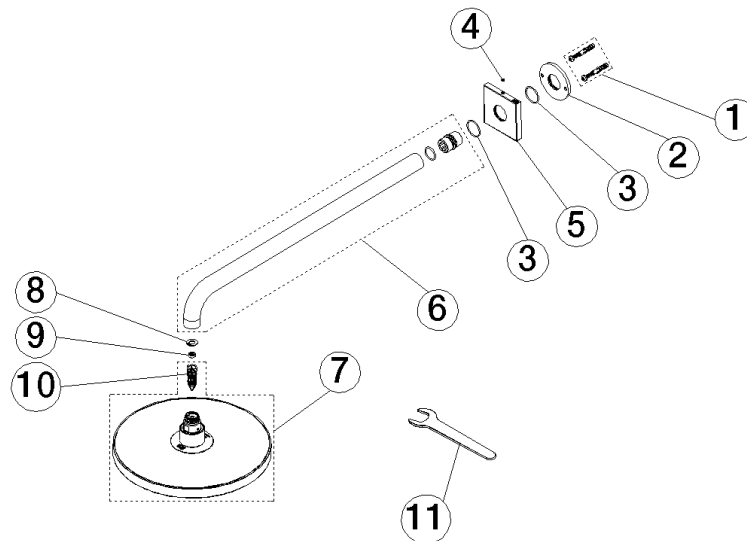

Ersatzteilstückliste

Nr.	Artikelnummer	Benennung	Verbaumenge	Lieferzeit
11	90 30 09 069 00 90	Montageschlüssel -	1,00	2
8	09 16 01 014 90	Ring Sicherungsring Ø 15 x 1 mm -	1,00	2
4	90 31 11 038 00 90	Befestigung Gewindestift mit Innensechskant mit Ringschneide M4 x 3 mm -	1,00	2
10	90 18 40 278 00 90	Rohrbelüfter Ø 14 x 37,5 mm, 7 l/min. -	1,00	2
6	90 11 03 070 00-42	Rohr 462 x 61 x 24 mm - Bronze gebürstet (PVD)	1,00	20
9	09 23 01 136 90	Durchflussbegrenzer -	1,00	2
7	90 12 05 094 00-42	Regenbrause rund Ø 220 mm - Bronze gebürstet (PVD)	1,00	20
5	09 27 67 015-42	Rosette 65 x 65 x 9 mm - Bronze gebürstet (PVD)	1,00	60
2	09 17 20 120 90	Anschluss Ø 56,50 x 5 mm -	1,00	2
1	04 30 31 032 00 90	Befestigungssatz Schraube 4 x 35 mm -	1,00	2
3	09 14 10 150 90	O-Ring 23 x 1,5 mm -	2,00	2