

**Data Sheet | Item Number: 2734-1108/327-000**

1-conductor female connector; lever; Push-in CAGE CLAMP®; 1.5 mm²; Pin spacing 3.5 mm; 8-pole; 100% protected against mismatching; 1,50 mm²; light gray

<https://www.wago.com/2734-1108/327-000>



Color: ■ light gray

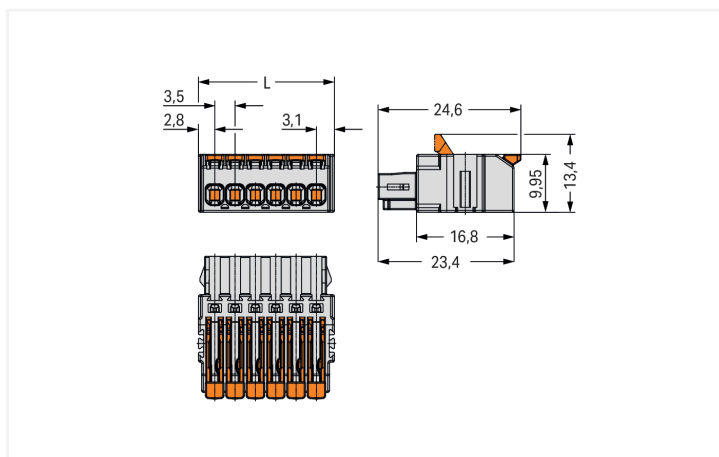

Dimensions in mm  
 $L = (\text{pole no.} \times \text{pin spacing}) + 2.4 \text{ mm}$

Female connector, 2734 Series, 0° conductor exit to connection direction

Convenient electrical installations are guaranteed with this female connector (item number 2734-1108/327-000). Strip lengths must be between 9 and 10 mm when connecting conductors to this female connector. This product incorporates one conductor terminal and utilizes Push-in CAGE CLAMP®. Push-in CAGE CLAMP® connection technology is ideal for connecting all conductor types. It allows direct insertion of both solid and fine-stranded con-



ductors with ferrules without needing to use any tools—all thanks to its pluggable design. The item's dimensions are (30.4 x 9.95 x 24.6) mm (width x height x depth). Depending on the type of conductor, this female connector is suitable for conductor cross sections ranging from 0.14 mm<sup>2</sup> to 1.5 mm<sup>2</sup>.

Tin is used for coating the contact surfaces.

Notes	
Safety Information	The MCS – MULTI CONNECTION SYSTEM includes connectors without breaking capacity in accordance with DIN EN 61984. When used as intended, these connectors must not be connected/disconnected when live or under load. When used as intended, these connectors must not be connected/disconnected when live or under load. The circuit design should ensure header pins, which can be touched, are not live when unmated.
Variants:	Other pole numbers Other versions (or variants) can be requested from WAGO Sales or configured at <a href="https://configurator.wago.com/">https://configurator.wago.com/</a> .

**Electrical data**

Ratings per	IEC/EN 60664-1			Approvals per	UL 1059		
Overvoltage category	III	III	II	Use group	B	C	D
Pollution degree	3	2	2	Rated voltage	300 V	-	300 V
Nominal voltage	160 V	160 V	320 V	Rated current	10 A	-	10 A
Rated impulse withstand voltage	2.5 kV	2.5 kV	2.5 kV				
Rated current	10 A	10 A	10 A				

Approvals per	CSA		
Use group	B	C	D
Rated voltage	300 V	-	300 V
Rated current	10 A	-	10 A

**Connection Data**

Clamping units	8	<b>Connection 1</b>	
Total number of potentials	8	Connection technology	Push-in CAGE CLAMP®
Number of connection types	1	Actuation type	Lever
Number of levels	1	Solid conductor	0.14 ... 1.5 mm <sup>2</sup> / 26 ... 14 AWG
		Solid conductor; push-in termination	0.34 ... 1.5 mm <sup>2</sup> / 22 ... 14 AWG
		Fine-stranded conductor	0.14 ... 1.5 mm <sup>2</sup> / 26 ... 14 AWG
		Fine-stranded conductor; with insulated ferrule	0.14 ... 0.75 mm <sup>2</sup>
		Fine-stranded conductor; with uninsulated ferrule	0.14 ... 1 mm <sup>2</sup>
		Strip length	9 ... 10 mm / 0.35 ... 0.39 inches
		Pole number	8
		Conductor entry direction to mating direction	0°

### Physical data

Pin spacing	3.5 mm / 0.138 inches
Width	30.4 mm / 1.197 inches
Height	9.95 mm / 0.392 inches
Depth	24.6 mm / 0.969 inches

### Mechanical data

Variable coding	Yes
Anti-rotation protection	Yes

### Plug-in connection

Contact type (pluggable connector)	Female connector/socket
Connector (connection type)	for conductor
Mismating protection	Yes

### Material data

Note (material data)	<a href="#">Information on material specifications can be found here</a>
Color	light gray
Material group	I
Insulation material (main housing)	Polyamide (PA66)
Flammability class per UL94	V0
Clamping spring material	Chrome-nickel spring steel (CrNi)
Contact material	Copper alloy
Contact Plating	Tin
Fire load	0.112 MJ
Weight	6.5 g

### Environmental requirements

Limit temperature range	-60 ... +100 °C
Processing temperature	-35 ... +60 °C

### Commercial data

Packaging type	Box
Country of origin	DE
GTIN	4066966216455
Customs tariff number	85366990990

### Product Classification

UNSPSC	39121409
ETIM 9.0	EC002638
ETIM 10.0	EC002638
ECCN	NO US CLASSIFICATION

**Environmental Product Compliance**

RoHS Compliance Status	Compliant, No Exemption
------------------------	-------------------------

**Approvals / Certificates**

**General approvals**



Approval	Standard	Certificate Name
CSA DEKRA Certification B.V.	C22.2 No. 158	2314554
UL Underwriters Laboratories Inc.	UL 1059	E45172
UL Underwriters Laboratories Inc.	UL 1977	E 45171

**Downloads**

**Environmental Product Compliance**

Compliance Search	
Environmental Product Compliance 2734-1108/327-000	<a href="#">↓</a>

**Documentation**

Additional Information			
Technical Section	03.04.2019	pdf 2027.26 KB	<a href="#">↓</a>

**CAD/CAE-Data**

CAD data	
2D/3D Models 2734-1108/327-000	<a href="#">↓</a>

PCB Design	
Symbol and Footprint via SamacSys 2734-1108/327-000	<a href="#">↓</a>
Symbol and Footprint via Ultra Librarian 2734-1108/327-000	<a href="#">↓</a>

## 1 Compatible Products

### 1.1 System counterpart

#### 1.1.1 Male connector/plug



**Item No.: 734-308**

1-conductor male connector; CAGE CLAMP®; 1.5 mm<sup>2</sup>; Pin spacing 3.5 mm; 8-pole; 100% protected against mismatching; 1,50 mm<sup>2</sup>; light gray

**Item No.: 734-168**

THT male header; 1.0 x 1.0 mm solder pin; angled; 100% protected against mismatching; Pin spacing 3.5 mm; 8-pole; light gray

**Item No.: 734-138**

THT male header; 1.0 x 1.0 mm solder pin; straight; 100% protected against mismatching; Pin spacing 3.5 mm; 8-pole; light gray

## 1.2 Optional Accessories

### 1.2.1 Coding

#### 1.2.1.1 Coding



**Item No.: 2734-505**

Coding pin carrier; 5 coding keys; for female connectors; orange

### 1.2.2 Ferrule

#### 1.2.2.1 Ferrule



**Item No.: 216-241**

Ferrule; Sleeve for 0.5 mm<sup>2</sup> / 20 AWG; insulated; electro-tin plated; electrolytic copper; gastight crimped; acc. to DIN 46228, Part 4/09.90; white

**Item No.: 216-141**

Ferrule; Sleeve for 0.5 mm<sup>2</sup> / 20 AWG; un-insulated; electro-tin plated; electrolytic copper; gastight crimped; acc. to DIN 46228, Part 1/08.92

**Item No.: 216-242**

Ferrule; Sleeve for 0.75 mm<sup>2</sup> / 18 AWG; insulated; electro-tin plated; electrolytic copper; gastight crimped; acc. to DIN 46228, Part 4/09.90; gray

**Item No.: 216-262**

Ferrule; Sleeve for 0.75 mm<sup>2</sup> / 18 AWG; insulated; electro-tin plated; electrolytic copper; gastight crimped; acc. to DIN 46228, Part 4/09.90; gray



**Item No.: 216-142**

Ferrule; Sleeve for 0.75 mm<sup>2</sup> / 18 AWG; un-insulated; electro-tin plated; electrolytic copper; gastight crimped; acc. to DIN 46228, Part 1/08.92

### 1.2.3 Jumper

#### 1.2.3.1 Jumper



**Item No.: 2734-402**

Jumper; for conductor entry; 2-way; insulated; light gray

## 1.2.4 Locking system

### 1.2.4.1 Locking system



**Item No.: 2734-516**

center locking; for female connectors; For Push-in CAGE CLAMP® connection; lever; Pin spacing 3.5 mm; 4-pole; orange

**Item No.: 2734-510**

Locking lever; for female connectors; 1 part; For Push-in CAGE CLAMP® connection; lever; orange

## 1.2.5 Strain relief

### 1.2.5.1 Strain relief plate



**Item No.: 2734-535**

Strain relief plate; for female connectors; 27 mm wide; 1 part; lever; Pin spacing 3.5 mm; light gray

## 1.2.6 Test and measurement

### 1.2.6.1 Testing accessories



**Item No.: 735-500**

WAGO Test pin; 1 mm Ø; 30 V AC / 60 V DC; CAT0; 1 A; 6 mm uninsulated; Test lead for soldering up to 0,5mm²

## Installation Notes

### Conductor termination

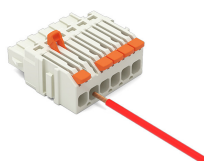
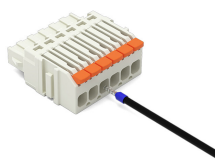
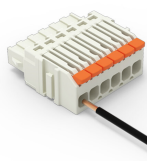

### Conductor removal

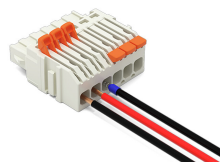

Testing

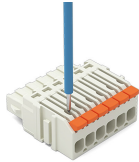
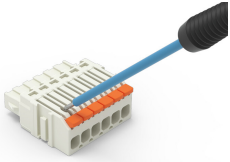

Marking

