

**Data Sheet | Item Number: 2734-1108/328-000**

1-conductor female connector; lever; Push-in CAGE CLAMP®; 1.5 mm<sup>2</sup>; Pin spacing 3.5 mm; 8-pole; 100% protected against mismatching; Centered locking levers; 1,50 mm<sup>2</sup>; light gray



<https://www.wago.com/2734-1108/328-000>



Color: ■ light gray

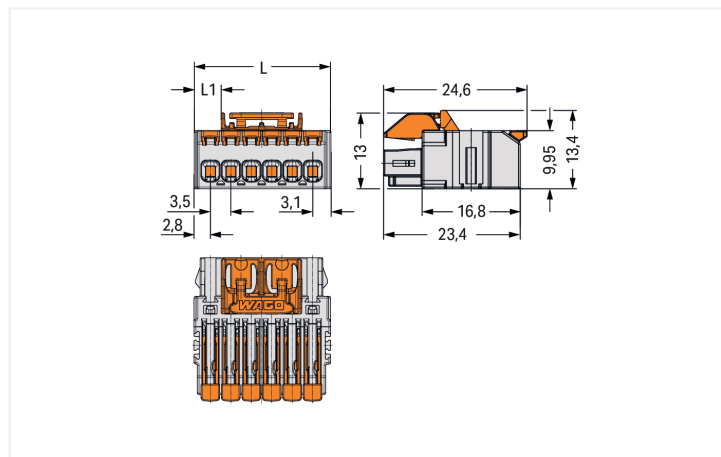

Dimensions in mm

$L = (\text{pole no.} \times \text{pin spacing}) + 2.4 \text{ mm}$  Pole no. 4:  $L1 = 1.15 \text{ mm}$  Pole no. 5 + 6:  $L1 = 4.65 \text{ mm}$  Pole no. 7 + 8:  $L1 = 8.15 \text{ mm}$  Pole no. 9 + 10:  $L1 = 11.65 \text{ mm}$  Pole no. 11 + 12:  $L1 = 15.15 \text{ mm}$  Pole no. 13 + 14:  $L1 = 18.65 \text{ mm}$  Pole no. 15 + 16:  $L1 = 22.15 \text{ mm}$

Female connector, 2734 Series, with 3.5 mm pin spacing

Our female connector (item number 2734-1108/328-000) ensures effortless electrical installations. Strip lengths must be between 9 and 10 mm when connecting conductors to this female connector. Featuring one conductor terminal along with Push-in CAGE CLAMP®, this product outperforms the competition. Our Push-in CAGE CLAMP® is a universal, maintenance-free connection solution for all conductor types, offering a key advantage: both solid and fine-stranded conductors with ferrules can be directly inserted without the need for tools or any preparation, such as crimping the ferrule. The item's dimensions are (30.4 x 13.4 x 24.6) mm (width x height x depth). This female connector is suitable for conductor cross sections ranging from 0.14 mm<sup>2</sup> to 1.5 mm<sup>2</sup>.

Tin is used for coating the contact surfaces.

## Notes

### Safety Information

The MCS – MULTI CONNECTION SYSTEM includes connectors without breaking capacity in accordance with DIN EN 61984. When used as intended, these connectors must not be connected/disconnected when live or under load. When used as intended, these connectors must not be connected/disconnected when live or under load. The circuit design should ensure header pins, which can be touched, are not live when unmated.

### Variants:

Other pole numbers  
Other versions (or variants) can be requested from WAGO Sales or configured at <https://configurator.wago.com/>.

## Electrical data

Ratings per	IEC/EN 60664-1		
Overvoltage category	III	III	II
Pollution degree	3	2	2
Nominal voltage	160 V	160 V	320 V
Rated impulse withstand voltage	2.5 kV	2.5 kV	2.5 kV
Rated current	10 A	10 A	10 A

Approvals per	UL 1059		
Use group	B	C	D
Rated voltage	300 V	-	300 V
Rated current	10 A	-	10 A

Approvals per	CSA		
Use group	B	C	D
Rated voltage	300 V	-	300 V
Rated current	10 A	-	10 A

## Connection Data

Clamping units	8
Total number of potentials	8
Number of connection types	1
Number of levels	1

### Connection 1

Connection technology	Push-in CAGE CLAMP®
Actuation type	Lever
Solid conductor	0.14 ... 1.5 mm <sup>2</sup> / 26 ... 14 AWG
Solid conductor; push-in termination	0.34 ... 1.5 mm <sup>2</sup> / 22 ... 14 AWG
Fine-stranded conductor	0.14 ... 1.5 mm <sup>2</sup> / 26 ... 14 AWG
Fine-stranded conductor; with insulated ferrule	0.14 ... 0.75 mm <sup>2</sup>
Fine-stranded conductor; with uninsulated ferrule	0.14 ... 1 mm <sup>2</sup>
Strip length	9 ... 10 mm / 0.35 ... 0.39 inches
Pole number	8
Conductor entry direction to mating direction	0°

### Physical data

Pin spacing	3.5 mm / 0.138 inches
Width	30.4 mm / 1.197 inches
Height	13.4 mm / 0.528 inches
Depth	24.6 mm / 0.969 inches

### Mechanical data

Variable coding	Yes
Anti-rotation protection	Yes

### Plug-in connection

Contact type (pluggable connector)	Female connector/socket
Connector (connection type)	for conductor
Mismating protection	Yes
Locking of plug-in connection	Center locking lever

### Material data

Note (material data)	<a href="#">Information on material specifications can be found here</a>
Color	light gray
Material group	I
Insulation material (main housing)	Polyamide (PA66)
Flammability class per UL94	V0
Clamping spring material	Chrome-nickel spring steel (CrNi)
Contact material	Copper alloy
Contact Plating	Tin
Fire load	0.119 MJ
Weight	6.8 g

### Environmental requirements

Limit temperature range	-60 ... +100 °C
Processing temperature	-35 ... +60 °C

### Commercial data

PU (SPU)	50 pcs
Packaging type	Box
Country of origin	DE
GTIN	4066966264128
Customs tariff number	85366990990

### Product Classification

UNSPSC	39121409
ETIM 9.0	EC002638
ETIM 10.0	EC002638
ECCN	NO US CLASSIFICATION

**Environmental Product Compliance**

RoHS Compliance Status	Compliant, No Exemption
------------------------	-------------------------

**Approvals / Certificates**

**General approvals**



Approval	Standard	Certificate Name
CSA DEKRA Certification B.V.	C22.2 No. 158	2314554
UL Underwriters Laboratories Inc.	UL 1059	E45172
UL Underwriters Laboratories Inc.	UL 1977	E 45171

**Downloads**

**Environmental Product Compliance**

Compliance Search	
Environmental Product Compliance 2734-1108/328-000	<a href="#">↓</a>

**Documentation**

Additional Information			
Technical Section	03.04.2019	pdf 2027.26 KB	<a href="#">↓</a>

**CAD/CAE-Data**

CAD data	
2D/3D Models 2734-1108/328-000	<a href="#">↓</a>

PCB Design	
Symbol and Footprint via SamacSys 2734-1108/328-000	<a href="#">↓</a>
Symbol and Footprint via Ultra Librarian 2734-1108/328-000	<a href="#">↓</a>

## 1 Compatible Products

### 1.1 System counterpart

#### 1.1.1 Male connector/plug



**Item No.: 734-308**

1-conductor male connector; CAGE CLAMP®; 1.5 mm²; Pin spacing 3.5 mm; 8-pole; 100% protected against mismatching; 1,50 mm²; light gray

**Item No.: 734-168**

THT male header; 1.0 x 1.0 mm solder pin; angled; 100% protected against mismatching; Pin spacing 3.5 mm; 8-pole; light gray

**Item No.: 734-138**

THT male header; 1.0 x 1.0 mm solder pin; straight; 100% protected against mismatching; Pin spacing 3.5 mm; 8-pole; light gray

## 1.2 Optional Accessories

### 1.2.1 Coding

#### 1.2.1.1 Coding



**Item No.: 2734-505**

Coding pin carrier; 5 coding keys; for female connectors; orange

### 1.2.2 Ferrule

#### 1.2.2.1 Ferrule



**Item No.: 216-241**

Ferrule; Sleeve for 0.5 mm² / 20 AWG; insulated; electro-tin plated; electrolytic copper; gastight crimped; acc. to DIN 46228, Part 4/09.90; white

**Item No.: 216-141**

Ferrule; Sleeve for 0.5 mm² / 20 AWG; un-insulated; electro-tin plated; electrolytic copper; gastight crimped; acc. to DIN 46228, Part 1/08.92

**Item No.: 216-242**

Ferrule; Sleeve for 0.75 mm² / 18 AWG; insulated; electro-tin plated; electrolytic copper; gastight crimped; acc. to DIN 46228, Part 4/09.90; gray

**Item No.: 216-262**

Ferrule; Sleeve for 0.75 mm² / 18 AWG; insulated; electro-tin plated; electrolytic copper; gastight crimped; acc. to DIN 46228, Part 4/09.90; gray



**Item No.: 216-142**

Ferrule; Sleeve for 0.75 mm² / 18 AWG; un-insulated; electro-tin plated; electrolytic copper; gastight crimped; acc. to DIN 46228, Part 1/08.92

### 1.2.3 Jumper

#### 1.2.3.1 Jumper



**Item No.: 2734-402**

Jumper; for conductor entry; 2-way; insulated; light gray

## 1.2.4 Strain relief

### 1.2.4.1 Strain relief plate



**Item No.: 2734-535**

Strain relief plate; for female connectors; 27 mm wide; 1 part; lever; Pin spacing 3.5 mm; light gray

## 1.2.5 Test and measurement

### 1.2.5.1 Testing accessories



**Item No.: 735-500**

WAGO Test pin; 1 mm Ø; 30 V AC / 60 V DC; CAT0; 1 A; 6 mm uninsulated; Test lead for soldering up to 0,5mm<sup>2</sup>

## Installation Notes

### Conductor termination

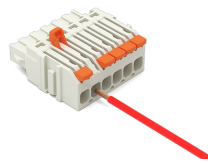
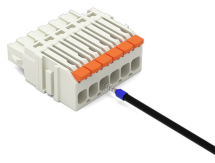
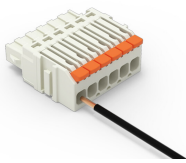

### Conductor removal

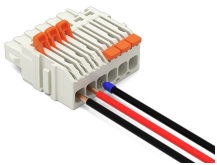

## Testing

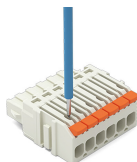
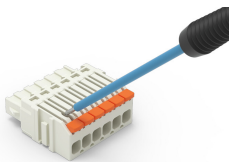

Marking

