

Data Sheet | Item Number: 2734-111

1-conductor female connector; push-button; Push-in CAGE CLAMP®; 1.5 mm²; Pin spacing 3.5 mm; 11-pole; 100% protected against mismatching; 1,50 mm²; light gray

<https://www.wago.com/2734-111>



Color: ■ light gray

Similar to illustration

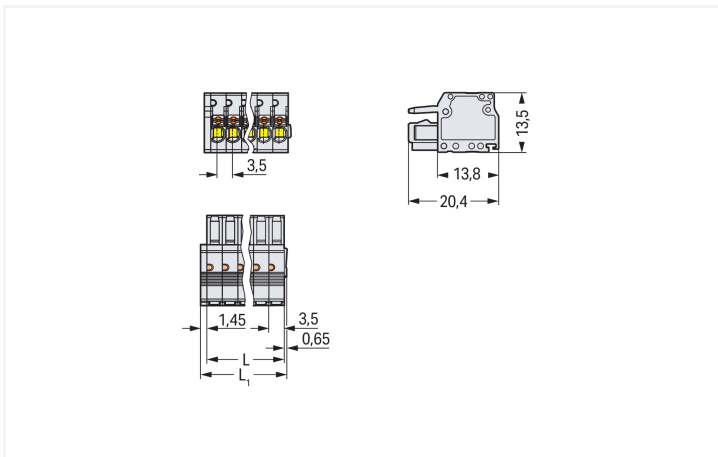
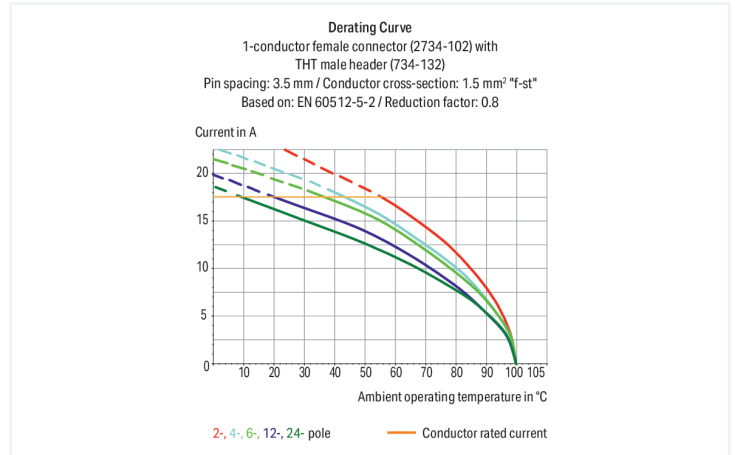

Dimensions in mm

$L = \text{pole no.} \times \text{pin spacing}$
 $L_1 = (\text{pole no.} \times \text{pin spacing}) + 2.1 \text{ mm}$

Female connector, 2734 Series, 0° conductor exit to connection direction

Enjoy convenient electrical installations with this female connector (item number 2734-111). Conductors should only be connected to this female connector if their strip length is between 8 and 9 mm. This product features one conductor terminal and utilizes Push-in CAGE CLAMP®. Push-in CAGE CLAMP® connection technology is ideal for connecting all conductor types. It allows direct insertion of both solid and fine-stranded conductors with ferrules without the need for tools—all thanks to its pluggable design. The item's dimensions are (40.6 x 13.5 x 20.4) mm (width x height x depth). Depending on the conductor type, this female connector is suitable for conductor cross sections ranging from 0.2 mm² to 1.5 mm².

The contact surface is coated with tin.

Notes

Safety Information

The MCS – MULTI CONNECTION SYSTEM includes connectors without breaking capacity in accordance with DIN EN 61984. When used as intended, these connectors must not be connected/disconnected when live or under load. When used as intended, these connectors must not be connected/disconnected when live or under load. The circuit design should ensure header pins, which can be touched, are not live when unmated.

Variants:

Other pole numbers
Gold-plated or partially gold-plated contact surfaces
Other versions (or variants) can be requested from WAGO Sales or configured at <https://configurator.wago.com/>.

Electrical data

| Ratings per | IEC/EN 60664-1 | | | Approvals per | UL 1059 | | |
|---------------------------------|----------------|--------|--------|---------------|-----------|---|-------|
| | III | III | II | | Use group | B | C |
| Overvoltage category | III | III | II | Use group | B | C | D |
| Pollution degree | 3 | 2 | 2 | Rated voltage | 300 V | - | 300 V |
| Nominal voltage | 160 V | 160 V | 320 V | Rated current | 10 A | - | 10 A |
| Rated impulse withstand voltage | 2.5 kV | 2.5 kV | 2.5 kV | | | | |
| Rated current | 10 A | 10 A | 10 A | | | | |

| Approvals per | CSA | | |
|---------------|-------|---|-------|
| Use group | B | C | D |
| Rated voltage | 300 V | - | 300 V |
| Rated current | 10 A | - | 10 A |

Connection Data

| | | | |
|----------------------------|----|---|---|
| Clamping units | 11 | Connection 1 | |
| Total number of potentials | 11 | Connection technology | Push-in CAGE CLAMP® |
| Number of connection types | 1 | Actuation type | Push-button |
| Number of levels | 1 | Actuation direction 1 | Operation parallel to conductor entry |
| | | Solid conductor | 0.2 ... 1.5 mm ² / 24 ... 16 AWG |
| | | Fine-stranded conductor | 0.2 ... 1.5 mm ² / 24 ... 16 AWG |
| | | Fine-stranded conductor; with insulated ferrule | 0.25 ... 0.75 mm ² |
| | | Fine-stranded conductor; with uninsulated ferrule | 0.25 ... 1.5 mm ² |
| | | Strip length | 8 ... 9 mm / 0.31 ... 0.35 inches |
| | | Pole number | 11 |
| | | Conductor entry direction to mating direction | 0° |

Physical data

| | |
|-------------|------------------------|
| Pin spacing | 3.5 mm / 0.138 inches |
| Width | 40.6 mm / 1.598 inches |
| Height | 13.5 mm / 0.531 inches |
| Depth | 20.4 mm / 0.803 inches |

Mechanical data

| | |
|--------------------------|-----|
| Variable coding | Yes |
| Anti-rotation protection | Yes |

Plug-in connection

| | |
|------------------------------------|-------------------------|
| Contact type (pluggable connector) | Female connector/socket |
| Connector (connection type) | for conductor |
| Mismating protection | Yes |

Material data

| | |
|------------------------------------|--|
| Note (material data) | Information on material specifications can be found here |
| Color | light gray |
| Material group | I |
| Insulation material (main housing) | Polyamide (PA66) |
| Flammability class per UL94 | V0 |
| Clamping spring material | Chrome-nickel spring steel (CrNi) |
| Contact material | Copper alloy |
| Contact Plating | Tin |
| Fire load | 0.171 MJ |
| Weight | 9.7 g |

Environmental requirements

| | |
|-------------------------|-----------------|
| Limit temperature range | -60 ... +100 °C |
| Processing temperature | -35 ... +60 °C |

Commercial data

| | |
|-----------------------|------------------------|
| Product Group | 3 (Multi Conn. System) |
| PU (SPU) | 50 pcs |
| Packaging type | Box |
| Country of origin | PL |
| GTIN | 4055143274616 |
| Customs tariff number | 85366990990 |

Product Classification

| | |
|-------------|----------------------|
| UNSPSC | 39121409 |
| eCl@ss 10.0 | 27-44-03-09 |
| eCl@ss 9.0 | 27-44-03-09 |
| ETIM 9.0 | EC002638 |
| ETIM 10.0 | EC002638 |
| ECCN | NO US CLASSIFICATION |

Environmental Product Compliance

RoHS Compliance Status Compliant, No Exemption

Approvals / Certificates

General approvals



| Approval | Standard | Certificate Name |
|--------------------------------------|---------------|------------------|
| CCA DEKRA Certification B.V. | IEC 61984 | NL-23611 |
| CCA DEKRA Certification B.V. | EN 61984 | 2147056.01 |
| CSA DEKRA Certification B.V. | C22.2 No. 158 | 2314554 |
| UL Underwriters Laboratories Inc. | UL 1977 | E 45171 |

Downloads

Environmental Product Compliance

Compliance Search

Environmental Product Compliance 2734-111 [↓](#)

Documentation

Additional Information

Technical Section 03.04.2019 pdf 2027.26 KB [↓](#)

CAD/CAE-Data

CAD data

2D/3D Models 2734-111 [↓](#)

CAE data

ZUKEN Portal 2734-111 [↓](#)

1 Compatible Products

1.1 System counterpart

1.1.1 Male connector/plug



Item No.: 734-311

1-conductor male connector; CAGE CLAMP®; 1.5 mm²; Pin spacing 3.5 mm; 11-pole; 100% protected against mismatching; 1,50 mm²; light gray

Item No.: 734-171

THT male header; 1.0 x 1.0 mm solder pin; angled; 100% protected against mismatching; Pin spacing 3.5 mm; 11-pole; light gray

Item No.: 734-141

THT male header; 1.0 x 1.0 mm solder pin; straight; 100% protected against mismatching; Pin spacing 3.5 mm; 11-pole; light gray

1.2 Optional Accessories

1.2.1 Ferrule

1.2.1.1 Ferrule



Item No.: 216-301

Ferrule; Sleeve for 0.25 mm² / AWG 24; insulated; electro-tin plated; yellow

Item No.: 216-302

Ferrule; Sleeve for 0.34 mm² / 22 AWG; insulated; electro-tin plated; light turquoise

Item No.: 216-201

Ferrule; Sleeve for 0.5 mm² / 20 AWG; insulated; electro-tin plated; electrolytic copper; acc. to DIN 46228, Part 4/09.90; white

Item No.: 216-241

Ferrule; Sleeve for 0.5 mm² / 20 AWG; insulated; electro-tin plated; electrolytic copper; gastight crimped; acc. to DIN 46228, Part 4/09.90; white



Item No.: 216-141

Ferrule; Sleeve for 0.5 mm² / 20 AWG; un-insulated; electro-tin plated; electrolytic copper; gastight crimped; acc. to DIN 46228, Part 1/08.92

Item No.: 216-101

Ferrule; Sleeve for 0.5 mm² / AWG 22; un-insulated; electro-tin plated; silver-colored

Item No.: 216-242

Ferrule; Sleeve for 0.75 mm² / 18 AWG; insulated; electro-tin plated; electrolytic copper; gastight crimped; acc. to DIN 46228, Part 4/09.90; gray

Item No.: 216-262

Ferrule; Sleeve for 0.75 mm² / 18 AWG; insulated; electro-tin plated; electrolytic copper; gastight crimped; acc. to DIN 46228, Part 4/09.90; gray



Item No.: 216-202

Ferrule; Sleeve for 0.75 mm² / 18 AWG; insulated; electro-tin plated; gray

Item No.: 216-142

Ferrule; Sleeve for 0.75 mm² / 18 AWG; un-insulated; electro-tin plated; electrolytic copper; gastight crimped; acc. to DIN 46228, Part 1/08.92

Item No.: 216-102

Ferrule; Sleeve for 0.75 mm² / AWG 20; un-insulated; electro-tin plated; silver-colored

1.2.2 Tool

1.2.2.1 Operating tool



Item No.: 734-190

Combination operating tool; natural

Item No.: 734-231

Operating tool; black

Item No.: 210-719

Operating tool; Blade: 2.5 x 0.4 mm; with a partially insulated shaft

Item No.: 210-647

Operating tool; Blade: 2.5 x 0.4 mm; with a partially insulated shaft; multicoloured



Item No.: 210-251

Operating tool; for MCS MICRO and MINI with CAGE CLAMP® connection; yellow

Item No.: 210-250

Operating tool; for MCS MINI and MIDI with CAGE CLAMP® connection; red

Item No.: 734-191

Operating tool; made of insulating material; 1-way; loose; black

Item No.: 734-230

Operating tool; made of insulating material; 1-way; white

Installation Notes

Conductor termination

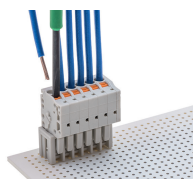

Conductor termination Inserting fine-stranded conductors into Push-in CAGE CLAMP® unit via push-buttons.

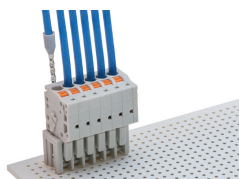

Push-in termination of solid conductors and fine-stranded conductors with ferrules

Testing

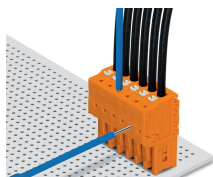

Testing via 1 mm Ø test pin (735-500).
Push-in CAGE CLAMP® termination – parallel to conductor entry

Marking

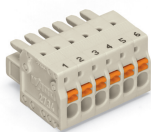

Labeling via direct marking or self-adhesive strips.

Installation

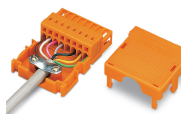

Strain relief housing for 734 Series Male and Female Connectors with CAGE CLAMP® connection