











Holder Spray arm 150 x 225 x 90 mm - Brushed Chrome

SPARE PARTS

90 17 20 045 00



	Brushed Chrome	90 17 20 045 00-93
	Chrome	90 17 20 045 00-00
	Brushed Platinum	90 17 20 045 00-06
	Platinum	90 17 20 045 00-08
	Durabronze (23kt Gold)	90 17 20 045 00-09
	Brushed Durabronze (23kt Gold)	90 17 20 045 00-28
	Matte Black	90 17 20 045 00-33
	Brushed Bronze (PVD)	90 17 20 045 00-42
	Brushed Champagne (22kt Gold)	90 17 20 045 00-46
	Champagne (22kt Gold)	90 17 20 045 00-47
	Brushed Dark Platinum	90 17 20 045 00-99



Holder Spray arm 150 x 225 x 90 mm - Brushed Chrome

SPARE PARTS

90 17 20 045 00



Holder Spray arm 150 x 225 x 90 mm - Brushed Chrome

SPARE PARTS

90 17 20 045 00

90 17 20 045 00

Parts for other finishes can be found here: [Chrome](#)

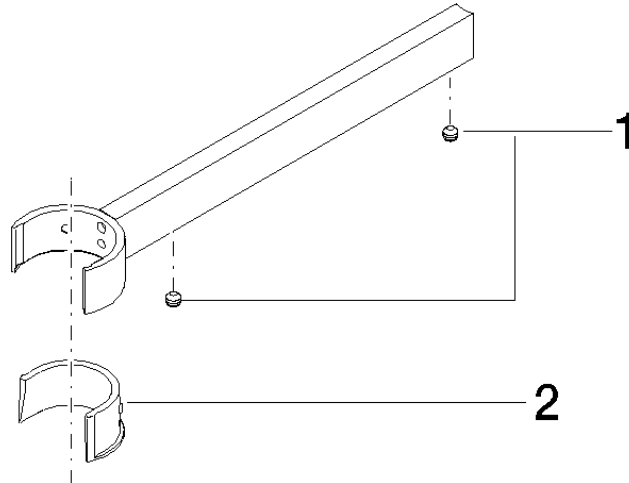

Spare parts list

No.	Item Number	Name	Quantity used	Delivery time
1	90 31 11 063 00 90	Mounting Threaded pin with hexagon socket with cup point M5 x 4 mm -	2.00	14
2	09 18 40 224 90	Sleeve 36 x 18,5 x 26,5 mm -	1.00	14