

## Data Sheet | Item Number: 734-108/107-000

1-conductor female connector; CAGE CLAMP®; 1.5 mm<sup>2</sup>; Pin spacing 3.5 mm; 8-po-  
le; 100% protected against mismatching; Screw flange; light gray

<https://www.wago.com/734-108/107-000>

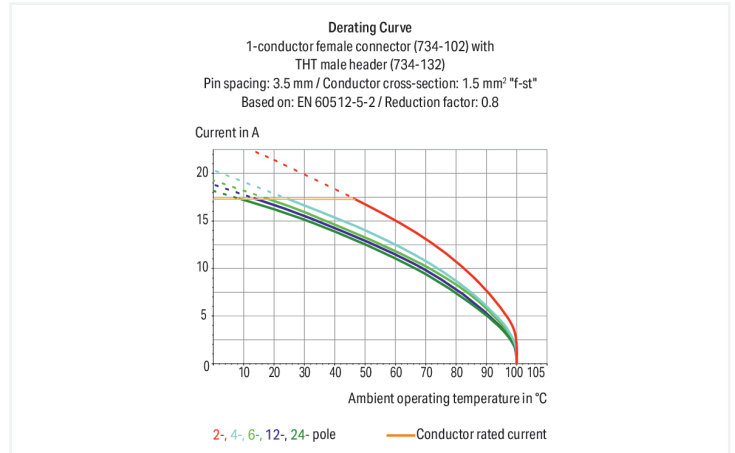

Color: ■ light gray

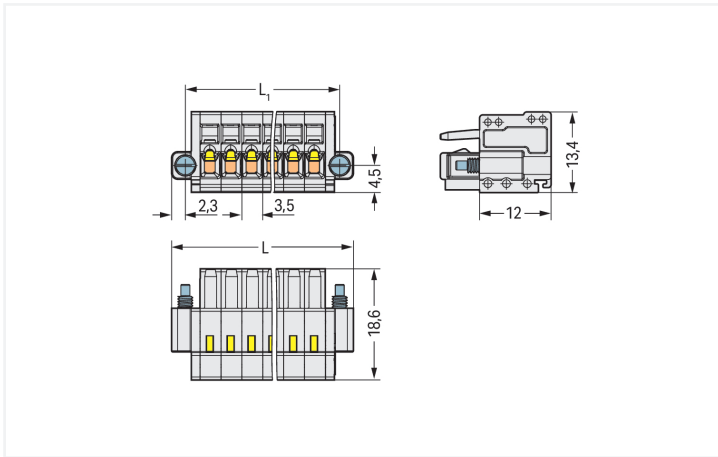

Dimensions in mm

$L = (\text{pole no.} \times \text{pin spacing}) + 9.5$  mm  
 $L1 = (\text{pole no.} \times \text{pin spacing}) + 4.9$  mm

Female connector, 734 Series, light gray

This female connector (item number 734-108/107-000) provides hassle-free electrical installations. Ensure that the strip lengths are between 6 and 7 mm when connecting conductors to this female connector. This product features one conductor terminal and utilizes CAGE CLAMP®. Our highly-rated and maintenance-free CAGE CLAMP® connection makes it easy to connect all conductor types without having to prepare the conductor. For example, you don't need to crimp ferrules. The item's dimensions are (37.5 x 13.4 x 18.6) mm (width x height x depth). This female connector is suitable for conductor cross sections ranging from 0.08 mm<sup>2</sup> to 1.5 mm<sup>2</sup>.

The contact surface is coated with tin.

## Notes

## Safety Information

The MCS – MULTI CONNECTION SYSTEM includes connectors without breaking capacity in accordance with DIN EN 61984. When used as intended, these connectors must not be connected/disconnected when live or under load. When used as intended, these connectors must not be connected/disconnected when live or under load. The circuit design should ensure header pins, which can be touched, are not live when unmated.

## Variants:

Other pole numbers  
Gold-plated or partially gold-plated contact surfaces  
Other versions (or variants) can be requested from WAGO Sales or configured at <https://configurator.wago.com/>.

## Electrical data

Ratings per	IEC/EN 60664-1		
Overvoltage category	III	III	II
Pollution degree	3	2	2
Nominal voltage	160 V	160 V	320 V
Rated impulse withstand voltage	2.5 kV	2.5 kV	2.5 kV
Rated current	10 A	10 A	10 A

Approvals per	UL 1059		
Use group	B	C	D
Rated voltage	300 V	-	300 V
Rated current	10 A	-	10 A

Approvals per	CSA		
Use group	B	C	D
Rated voltage	300 V	-	300 V
Rated current	10 A	-	10 A

## Connection Data

Clamping units	8
Total number of potentials	8
Number of connection types	1
Number of levels	1

Connection 1	
Connection technology	CAGE CLAMP®
Actuation type	Operating tool
Actuation direction 1	Operation parallel to conductor entry
Actuation direction 2	Operation perpendicular to conductor entry
Solid conductor	0.08 ... 1.5 mm <sup>2</sup> / 28 ... 14 AWG
Fine-stranded conductor	0.08 ... 1.5 mm <sup>2</sup> / 28 ... 14 AWG
Fine-stranded conductor; with insulated ferrule	0.25 ... 1.5 mm <sup>2</sup>
Fine-stranded conductor; with uninsulated ferrule	0.25 ... 1.5 mm <sup>2</sup>
Note (conductor cross-section)	Terminating 1.5 mm <sup>2</sup> conductors is possible; however insulation diameter does not allow clamping units to be terminated in a row.
Strip length	6 ... 7 mm / 0.24 ... 0.28 inches
Pole number	8
Conductor entry direction to mating direction	0°

### Physical data

Pin spacing	3.5 mm / 0.138 inches
Width	37.5 mm / 1.476 inches
Height	13.4 mm / 0.528 inches
Depth	18.6 mm / 0.732 inches

### Mechanical data

Variable coding	Yes
Anti-rotation protection	Yes

### Plug-in connection

Contact type (pluggable connector)	Female connector/socket
Connector (connection type)	for conductor
Mismating protection	Yes
Locking of plug-in connection	Screw flange

### Material data

Note (material data)	<a href="#">Information on material specifications can be found here</a>
Color	light gray
Material group	I
Insulation material (main housing)	Polyamide (PA66)
Flammability class per UL94	V0
Clamping spring material	Chrome-nickel spring steel (CrNi)
Contact material	Copper alloy
Contact Plating	Tin
Fire load	0.104 MJ
Weight	6.9 g

### Environmental requirements

Limit temperature range	-60 ... +100 °C
Processing temperature	-35 ... +60 °C

### Environmental Testing

Test specification: Railway applications – Rolling stock – Electronic equipment	DIN EN 50155 (VDE 0115-200):2022-06
Test procedure: Railway applications – Rolling stock equipment – Vibration and shock tests	DIN EN 61373 (VDE 0115-0106):2011-04
Spectrum/Mounting location	Service life test, Category 1, Class A/B
Functional test with noise-like oscillations	Test passed according to Section 8 of the standard
Frequency	$f_1 = 5 \text{ Hz}$ to $f_2 = 150 \text{ Hz}$
Acceleration	0.101g (highest test level used for all axes)
Test duration per axis	10 min.
Test directions	X, Y and Z axes
Monitoring of contact faults and interruptions	Passed
Voltage drop measurement before and after each axis	Passed
Simulated service life test through increased levels of noise-like oscillations	Test passed according to Section 9 of the standard
Frequency	$f_1 = 5 \text{ Hz}$ to $f_2 = 150 \text{ Hz}$
Acceleration	0.572g (highest test level used for all axes)
Test duration per axis	5 h

### Environmental Testing

Test directions	X, Y and Z axes
Extended testing: Monitoring of contact faults and interruptions	Passed
Extended testing: Voltage drop measurement before and after each axis	Passed
Shock test	Test passed according to Section 10 of the standard
Shock pulse form	Half sine
Acceleration	5g (highest test level used for all axes)
Shock duration	30 ms
Number of shocks (per axis)	3 pos. und 3 neg.
Test directions	X, Y and Z axes
Extended testing: Monitoring of contact faults and interruptions	Passed
Extended testing: Voltage drop measurement before and after each axis	Passed
Vibration and shock stress for rolling stock equipment	Passed

### Commercial data

Product Group	3 (Multi Conn. System)
PU (SPU)	50 pcs
Packaging type	Box
Country of origin	DE
GTIN	4045454618964
Customs tariff number	85366990990

### Product Classification

UNSPSC	39121409
eCl@ss 10.0	27-44-03-09
eCl@ss 9.0	27-44-03-09
ETIM 9.0	EC002638
ETIM 10.0	EC002638
ECCN	NO US CLASSIFICATION

### Environmental Product Compliance

RoHS Compliance Status	Compliant, No Exemption
------------------------	-------------------------

### Approvals / Certificates

#### General approvals



Approval	Standard	Certificate Name
CSA DEKRA Certification B.V.	C22.2	1465035
UL Underwriters Laboratories Inc.	UL 1977	E 45171

#### Declarations of conformity and manufacturer's declarations



Approval	Standard	Certificate Name
Railway WAGO GmbH & Co. KG	-	Railway Ready

Approvals for marine applications



Approval	Standard	Certificate Name
BV Bureau Veritas S.A.	IEC 60998	11915/E0 BV
DNV DNV GL SE	-	TAE000016Z
PRS Polski Rejestr Statków	-	TE/1095/880590/23

Downloads

Environmental Product Compliance

Compliance Search
Environmental Product Compliance 734-108/107-000

Documentation

Additional Information			
Technical Section	03.04.2019	pdf 2027.26 KB	

CAD/CAE-Data

CAD data
2D/3D Models 734-108/107-000

CAE data
ZUKEN Portal 734-108/107-000

1 Compatible Products

1.1 System counterpart

1.1.1 Male connector/plug

<p><b>Item No.: 734-308/109-000</b>                      1-conductor male connector; CAGE CLAMP®; 1.5 mm²; Pin spacing 3.5 mm; 8-pole; 100% protected against mismatching; Threaded flange; light gray</p>	<p><b>Item No.: 734-168/108-000</b>                      THT male header; 1.0 x 1.0 mm solder pin; angled; 100% protected against mismatching; Threaded flange; Pin spacing 3.5 mm; 8-pole; light gray</p>	<p><b>Item No.: 734-138/108-000</b>                      THT male header; 1.0 x 1.0 mm solder pin; straight; 100% protected against mismatching; Threaded flange; Pin spacing 3.5 mm; 8-pole; light gray</p>

1.2 Optional Accessories

1.2.1 Ferrule

1.2.1.1 Ferrule



**Item No.: 216-301**

Ferrule; Sleeve for 0.25 mm<sup>2</sup> / AWG 24; insulated; electro-tin plated; yellow



**Item No.: 216-321**

Ferrule; Sleeve for 0.25 mm<sup>2</sup> / AWG 24; insulated; electro-tin plated; yellow



**Item No.: 216-131**

Ferrule; Sleeve for 0.25 mm<sup>2</sup> / AWG 24; uninsulated; electro-tin plated; silver-colored



**Item No.: 216-302**

Ferrule; Sleeve for 0.34 mm<sup>2</sup> / 22 AWG; insulated; electro-tin plated; light turquoise



**Item No.: 216-322**

Ferrule; Sleeve for 0.34 mm<sup>2</sup> / 22 AWG; insulated; electro-tin plated; light turquoise



**Item No.: 216-132**

Ferrule; Sleeve for 0.34 mm<sup>2</sup> / AWG 24; uninsulated; electro-tin plated



**Item No.: 216-201**

Ferrule; Sleeve for 0.5 mm<sup>2</sup> / 20 AWG; insulated; electro-tin plated; electrolytic copper; acc. to DIN 46228, Part 4/09.90; white



**Item No.: 216-241**

Ferrule; Sleeve for 0.5 mm<sup>2</sup> / 20 AWG; insulated; electro-tin plated; electrolytic copper; gastight crimped; acc. to DIN 46228, Part 4/09.90; white



**Item No.: 216-221**

Ferrule; Sleeve for 0.5 mm<sup>2</sup> / 20 AWG; insulated; electro-tin plated; white



**Item No.: 216-141**

Ferrule; Sleeve for 0.5 mm<sup>2</sup> / 20 AWG; uninsulated; electro-tin plated; electrolytic copper; gastight crimped; acc. to DIN 46228, Part 1/08.92



**Item No.: 216-101**

Ferrule; Sleeve for 0.5 mm<sup>2</sup> / AWG 22; uninsulated; electro-tin plated; silver-colored



**Item No.: 216-121**

Ferrule; Sleeve for 0.5 mm<sup>2</sup> / AWG 22; uninsulated; electro-tin plated; silver-colored



**Item No.: 216-242**

Ferrule; Sleeve for 0.75 mm<sup>2</sup> / 18 AWG; insulated; electro-tin plated; electrolytic copper; gastight crimped; acc. to DIN 46228, Part 4/09.90; gray



**Item No.: 216-262**

Ferrule; Sleeve for 0.75 mm<sup>2</sup> / 18 AWG; insulated; electro-tin plated; electrolytic copper; gastight crimped; acc. to DIN 46228, Part 4/09.90; gray



**Item No.: 216-202**

Ferrule; Sleeve for 0.75 mm<sup>2</sup> / 18 AWG; insulated; electro-tin plated; gray



**Item No.: 216-222**

Ferrule; Sleeve for 0.75 mm<sup>2</sup> / 18 AWG; insulated; electro-tin plated; gray



**Item No.: 216-142**

Ferrule; Sleeve for 0.75 mm<sup>2</sup> / 18 AWG; uninsulated; electro-tin plated; electrolytic copper; gastight crimped; acc. to DIN 46228, Part 1/08.92



**Item No.: 216-102**

Ferrule; Sleeve for 0.75 mm<sup>2</sup> / AWG 20; uninsulated; electro-tin plated; silver-colored



**Item No.: 216-122**

Ferrule; Sleeve for 0.75 mm<sup>2</sup> / AWG 20; uninsulated; electro-tin plated; silver-colored



**Item No.: 216-243**

Ferrule; Sleeve for 1 mm<sup>2</sup> / AWG 18; insulated; electro-tin plated; electrolytic copper; gastight crimped; acc. to DIN 46228, Part 4/09.90; red



**Item No.: 216-263**

Ferrule; Sleeve for 1 mm<sup>2</sup> / AWG 18; insulated; electro-tin plated; electrolytic copper; gastight crimped; acc. to DIN 46228, Part 4/09.90; red



**Item No.: 216-203**

Ferrule; Sleeve for 1 mm<sup>2</sup> / AWG 18; insulated; electro-tin plated; red



**Item No.: 216-223**

Ferrule; Sleeve for 1 mm<sup>2</sup> / AWG 18; insulated; electro-tin plated; red



**Item No.: 216-103**

Ferrule; Sleeve for 1 mm<sup>2</sup> / AWG 18; uninsulated; electro-tin plated



**Item No.: 216-143**

Ferrule; Sleeve for 1 mm<sup>2</sup> / AWG 18; uninsulated; electro-tin plated; electrolytic copper; gastight crimped; acc. to DIN 46228, Part 1/08.92



**Item No.: 216-123**

Ferrule; Sleeve for 1 mm<sup>2</sup> / AWG 18; uninsulated; electro-tin plated; silver-colored



**Item No.: 216-204**

Ferrule; Sleeve for 1.5 mm<sup>2</sup> / AWG 16; insulated; electro-tin plated; black



**Item No.: 216-224**

Ferrule; Sleeve for 1.5 mm<sup>2</sup> / AWG 16; insulated; electro-tin plated; black



**Item No.: 216-244**

Ferrule; Sleeve for 1.5 mm<sup>2</sup> / AWG 16; insulated; electro-tin plated; electrolytic copper; gastight crimped; acc. to DIN 46228, Part 4/09.90; black



**Item No.: 216-264**

Ferrule; Sleeve for 1.5 mm<sup>2</sup> / AWG 16; insulated; electro-tin plated; electrolytic copper; gastight crimped; acc. to DIN 46228, Part 4/09.90; black



**Item No.: 216-284**

Ferrule; Sleeve for 1.5 mm<sup>2</sup> / AWG 16; insulated; electro-tin plated; electrolytic copper; gastight crimped; acc. to DIN 46228, Part 4/09.90; black



**Item No.: 216-124**

Ferrule; Sleeve for 1.5 mm<sup>2</sup> / AWG 16; uninsulated; electro-tin plated



**Item No.: 216-144**

Ferrule; Sleeve for 1.5 mm<sup>2</sup> / AWG 16; uninsulated; electro-tin plated; electrolytic copper; gastight crimped; acc. to DIN 46228, Part 1/08.92; silver-colored



**Item No.: 216-104**

Ferrule; Sleeve for 1.5 mm<sup>2</sup> / AWG 16; uninsulated; electro-tin plated; silver-colored

## 1.2.2 Insulation stop

### 1.2.2.1 Insulation stop



**Item No.: 734-671**

Insulation stop; 0.08 - 0.2 mm<sup>2</sup> "s" (0.14 mm<sup>2</sup> "f-st"); 8 pieces/strip; light gray

## 1.2.3 Marking

### 1.2.3.1 Marking strip



**Item No.: 210-332/350-202**

Marking strips; as a DIN A4 sheet; MARKED; 1-16 (240x); Height of marker strip: 3 mm; Strip length 182 mm; Horizontal marking; Self-adhesive; white



**Item No.: 210-332/350-204**

Marking strips; as a DIN A4 sheet; MARKED; 17-32 (240x); Height of marker strip: 3 mm; Strip length 182 mm; Horizontal marking; Self-adhesive; white



**Item No.: 210-332/350-206**

Marking strips; as a DIN A4 sheet; MARKED; 33-48 (240x); Height of marker strip: 3 mm; Strip length 182 mm; Horizontal marking; Self-adhesive; white

## 1.2.4 Strain relief

### 1.2.4.1 Strain relief housing



**Item No.: 734-608**

Strain relief housing; for female and male connectors; 2 parts; Pin spacing 3.5 mm; 8-pole; light gray

### 1.2.4.2 Strain relief plate



**Item No.: 734-128**

Strain relief plate; for female and male connectors; 12.5 mm wide; 1 part; Pin spacing 3.5 mm; light gray

## 1.2.5 Test and measurement

### 1.2.5.1 Testing accessories



**Item No.: 735-500**

WAGO Test pin; 1 mm Ø; 30 V AC / 60 V DC; CAT0; 1 A; 6 mm uninsulated; Test lead for soldering up to 0,5mm<sup>2</sup>

## 1.2.6 Tool

### 1.2.6.1 Operating tool



**Item No.: 734-190**

Combination operating tool; natural



**Item No.: 734-231**

Operating tool; black



**Item No.: 210-719**

Operating tool; Blade: 2.5 x 0.4 mm; with a partially insulated shaft



**Item No.: 210-647**

Operating tool; Blade: 2.5 x 0.4 mm; with a partially insulated shaft; multicoloured



**Item No.: 210-251**

Operating tool; for MCS MICRO and MINI with CAGE CLAMP® connection; yellow



**Item No.: 210-250**

Operating tool; for MCS MINI and MIDI with CAGE CLAMP® connection; red



**Item No.: 734-191**

Operating tool; made of insulating material; 1-way; loose; black



**Item No.: 734-230**

Operating tool; made of insulating material; 1-way; white

## Installation Notes

### Conductor termination

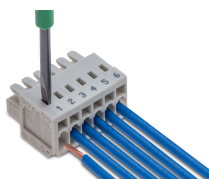

Inserting a conductor via (2.5 x 0.4) mm screwdriver – CAGE CLAMP® actuation perpendicular to conductor entry.



Inserting a conductor via (2.5 x 0.4) mm screwdriver – CAGE CLAMP® actuation parallel to conductor entry.

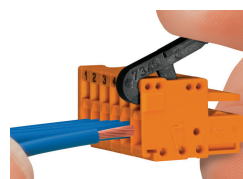

Inserting a conductor into CAGE CLAMP® unit via operating tool (734-191).

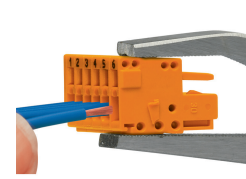

Inserting a conductor into CAGE CLAMP® unit via operating tool (210-251 or 210-250).

## Coding

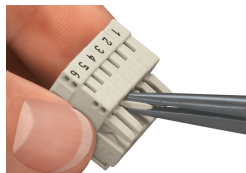

Coding a female connector – removing coding finger(s).

## Testing

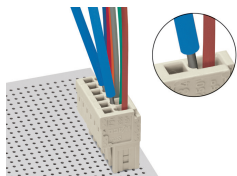

Testing via 1 mm Ø test pin (735-500) – CAGE CLAMP® connection – touch contact.

## Marking

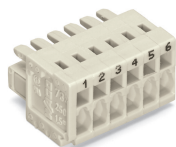

Labeling via direct marking or self-adhesive strips.

Installation

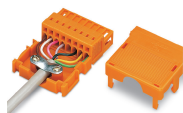

Strain relief housing for 734 Series Male and Female Connectors with CAGE CLAMP® connection