

Productinformatieblad

Specificaties



Kop voor verlichte keuzeschakelaar, 3 standen, Ø22mm, Wit

ZB4BK1813

Belangrijk bericht: A change in appearance may be noted on the product but does not affect its use in terms of function and safety. This makes it compatible with our Universal LED blocks
EAN Code: 3389110891027

Prijs: 32,35 EUR

Hoofd

range of product	Harmony XB4
product of component type	Kop voor verlichte keuzeschakelaar
compatibiliteit product	Universele LED
device short name	ZB4
kraag materiaal	Verchroomd metaal
koptype	Standaard
bevestigingsdiameter	22,5 mm
verkoop per ondeelbare hoeveelheid	1
vorm van kop signaleringseenheid	Rond
type operator	Van rechts naar het midden terugverend
profiel operator	Wit standaard hendel
informatie positie operator	3 standen +/- 45°
kap/operator of lenskleur	Wit

Complementair

CAD totale breedte	29 mm
CAD totale hoogte	29 mm
CAD totale diepte	43 mm
gewicht product	0,036 kg
weerstand hoge druk drukkring	7000000 Pa om 55 °C, afstand: 0.1 m
mechanical durability	500000 cycles
elektrische samenstellingscode	M3 voor <4 contacten gebruik enkelvoudig blokken in vooraan gemonteerd met integrale LED M6 voor <2 contacten gebruik enkelvoudig blokken in vooraan gemonteerd met ingebouwde LED en transformator M10 voor <2 contacten gebruik enkelvoudig blokken in vooraan gemonteerd met integrale LED M4 voor <4 contacten gebruik enkelvoudig en dubbel blokken in vooraan gemonteerd met integrale LED
product presentatie	Basisonderdeel

Omgeving

beschermende behandeling	TH
--------------------------	----

De weergegeven prijs is de adviesprijs in euro excl. BTW. Deze kan onderhevig zijn aan korting. Neem contact op met uw lokale distributeur of detailhandel voor de daadwerkelijke prijs

ambient air temperature for storage	-40...70 °C
omgevingstemperatuur voor werking	-40...70 °C
overvoltage category	Klasse I In overeenstemming met IEC 60536
IP beschermingsgraad	IP66 In overeenstemming met IEC 60529 IP67 IP69 IP69K
Enclosure Type	UL type 4X/13
IK-beschermingsgraad	IK04 In overeenstemming met IEC 50102
standards	IEC 60947-5-5 IEC 60947-5-4 JIS C8201-5-1 IEC 60947-5-1 CSA C22.2 Nr 14 IEC 60947-1 UL 508 JIS C8201-1
product certifications	BV CSA DNV LROS (Lloyds register of shipping) UL listed
trilling bestendigheid	5 gn (f= 2...500 Hz) In overeenstemming met IEC 60068-2-6
schokbestendigheid	30 gn (duur = 18 ms) voor halve sinusgolf versnelling In overeenstemming met IEC 60068-2-27 50 gn (duur = 11 ms) voor halve sinusgolf versnelling In overeenstemming met IEC 60068-2-27

Verpakkingseenheid

Eenheidstype van verpakking 1	PCE
Aantal eenheden in verpakking 1	1
verpakking 1 hoogte	5,59 cm
verpakking 1 breedte	3,3 cm
verpakking 1 lengte	5,59 cm
verpakking_1_gewicht	0,04 kg
Eenheidstype van verpakking 2	BB1
Aantal eenheden in verpakking 2	5
verpakking 2 hoogte	4,8 cm
verpakking 2 breedte	26,5 cm
verpakking 2 lengte	3,3 cm
verpakking 2 gewicht	205 g
Eenheidstype van verpakking 3	S03
Aantal eenheden in verpakking 3	250
verpakking_3_hoogte	30 cm
verpakking 3 breedte	30 cm
verpakking 3 lengte	40 cm
verpakking 3 gewicht	10,974 kg

contractuele waarborg

Schneider Electric wil tegen 2050 de Net Zero-status hebben bereikt via partnerschappen in de toeleveringsketen, materialen met een lagere impact en circulariteit via onze doorlopende campagne "Use Better, Use Longer, Use Again" om de levensduur van producten en de recycleerbaarheid te verlengen.

[Uitleg van Environmental Data >](#)

[Hoe evalueren we de duurzaamheid van producten? >](#)

Milieuoetafdruk

Totale levenscyclus ecologische voetafdruk	0.4 kg CO2 eq.
Koolstofvoetafdruk van de fabricagefase [A1–A3]	0.3 kg CO2 eq.
Koolstofvoetafdruk van de distributiefase [A4]	0 kg CO2 eq.
Koolstofvoetafdruk van de installatiefase [A5]	0 kg CO2 eq.
Koolstofvoetafdruk van de gebruiksfase [B2, B3, B4, B6]	0 kg CO2 eq.
Koolstofvoetafdruk van de einde-levensfase [C1–C4]	0.1 kg CO2 eq.
Milieu Profiel	Milieuprofiel van het product

Use Better

Materialen en verpakking

Pakket met gerecycleerd karton	Nee
Verpakkingen zonder kunststof	Nee
RoHS-richtlijn van de EU	Conform
REACH-verordening	Referentie bevat geen SVHC boven drempelwaarde

Use Longer

Levensduurverlenging

Reparatie	Nee
-----------	-----

Use Again

Herverpakken en herfabriceren

Circulair Profiel	Informatie over einde levensduur
Terugname	Ja

Dimensions Drawings

Dimensions

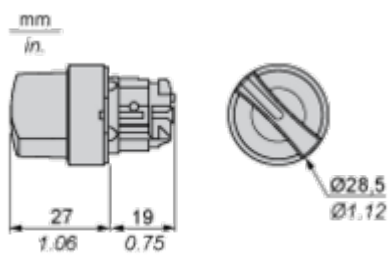

Mounting and Clearance

Panel Cut-out for Pushbuttons, Switches and Pilot Lights (Finished Holes, Ready for Installation)

Connection by Screw Clamp Terminals or Plug-in Connectors or on Printed Circuit Board	Connection by Faston Connectors
	
<p>(1) Diameter on finished panel or support (2) 40 mm min. / 1.57 in. min. (3) 30 mm min. / 1.18 in. min. (4) $\varnothing 22.5 \text{ mm} / 0.89 \text{ in. recommended } (\varnothing 22.3 \text{ mm }_0^{+0.4} / 0.88 \text{ in. }_0^{+0.016})$ (5) 45 mm min. / 1.78 in. min. (6) 32 mm min. / 1.26 in. min.</p>	

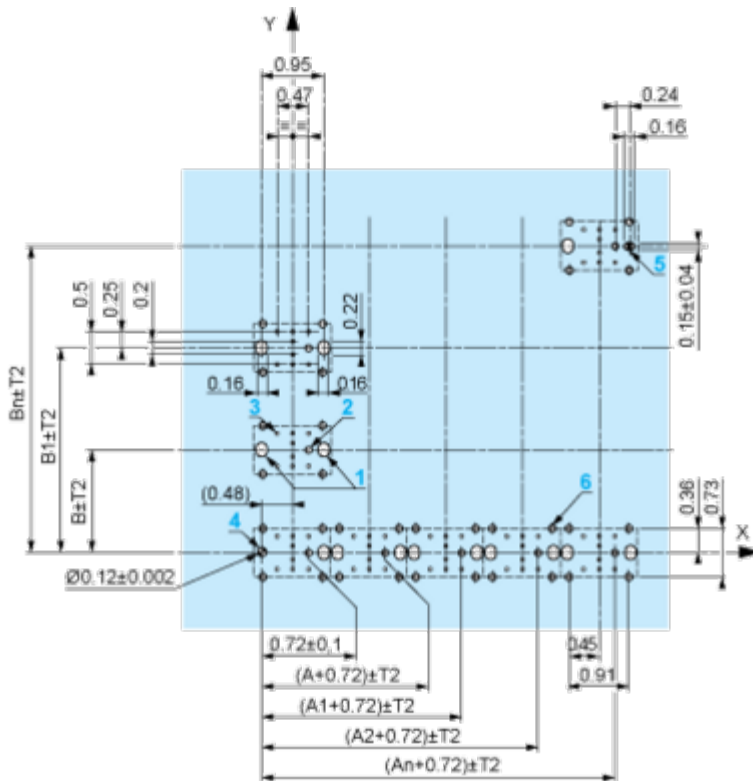

A: 1.18 in. min.

B: 1.57 in. min.

General Tolerances of the Panel and Printed Circuit Board

The cumulative tolerance must not exceed 0.3 mm / 0.012 in: T1 + T2 = 0.3 mm max.

Installation Precautions

- Minimum thickness of circuit board: 1.6 mm / 0.06 in.
- Cut-out diameter: 22.4 mm ± 0.1 / 0.88 in. ± 0.004
- Orientation of body/fixing collar ZB4 BZ009: ± 2° 30' (excluding cut-outs marked a and b).
- Tightening torque of screws ZBZ 006: 0.6 N.m (5.3 lbf.in) max.
- Allow for one ZB4 BZ079 fixing collar/pillar and its fixing screws:
 - every 90 mm / 3.54 in. horizontally (X), and 120 mm / 4.72 in. vertically (Y).
 - with each selector switch head (ZB4 BD*, ZB4 BJ*, ZB4 BG*).

The fixing centers marked a and b are diagonally opposed and must align with those marked 4 and 5.

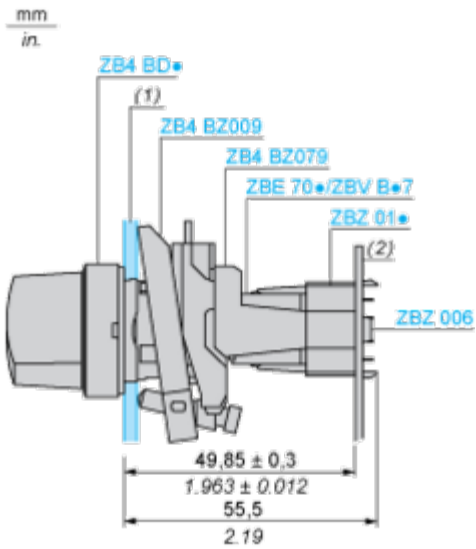

(1) Panel

(2) Printed circuit board

Mounting of Adapter (Socket) ZBZ 01•

- 1 2 elongated holes for ZBZ 006 screw access
- 2 1 hole $\varnothing 2.4 \text{ mm} \pm 0.05 / 0.09 \text{ in.} \pm 0.002$ for centring adapter ZBZ 01•
- 3 $8 \times \varnothing 1.2 \text{ mm} / 0.05 \text{ in.}$ holes
- 4 1 hole $\varnothing 2.9 \text{ mm} \pm 0.05 / 0.11 \text{ in.} \pm 0.002$, for aligning the printed circuit board (with cut-out marked a)
- 5 1 elongated hole for aligning the printed circuit board (with cut-out marked b)
- 6 4 holes $\varnothing 2.4 \text{ mm} / 0.09 \text{ in.}$ for clipping in adapter ZBZ 01•

Dimensions An + 18.1 relate to the $\varnothing 2.4 \text{ mm} \pm 0.05 / 0.09 \text{ in.} \pm 0.002$ holes for centring adapter ZBZ 01•.

Technical Description

Electrical Composition Corresponding to Code M3

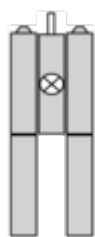

Electrical Composition Corresponding to Code M4



Electrical Composition Corresponding to Codes M6 and P2



Electrical Composition Corresponding to Codes M5, M10, MF1, MR1 and MF2

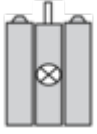

Legend

Single contact



Double contact



Light block



Possible location



Sequence of Contacts Fitted to 3-position Selector Switch Body

Position 315°



Push	Position	Top			
		Bottom			
	Location		Left		Right
	State		1		0
Contacts	N/O		closed	open	
	N/C		open	closed	

Position 0°



Push	Position	Top			
		Bottom			
	Location		Left		Right
	State		0		0
Contacts	N/O		open	open	
	N/C		closed	closed	

Position 45°



Push	Position	Top			
		Bottom			
	Location		Left		Right
	State		0		1
	Contacts	N/O			open
N/C		closed	open		

Technical Illustration

Dimensions

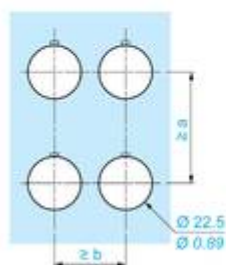
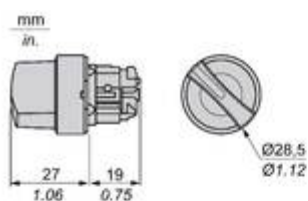

		a (mm)	a (in.)	b (mm)	b (in.)
		40	1.57	30	1.18
ZBE.....	ZBV.....				
		45	1.77	32	1.26
ZBE.....3	ZBV.....3				
		40	1.57	30	1.18
ZBE.....4	ZBV.....4				
		50	1.97	30	1.18
ZBE.....5	ZBV.....5				
		40	1.57	30	1.18
ZBE.....9	ZBV.....9				
		40	1.57	30	1.18
ZBRT•	ZBRV1				

Offer Marketing Illustration

Product benefits / Features

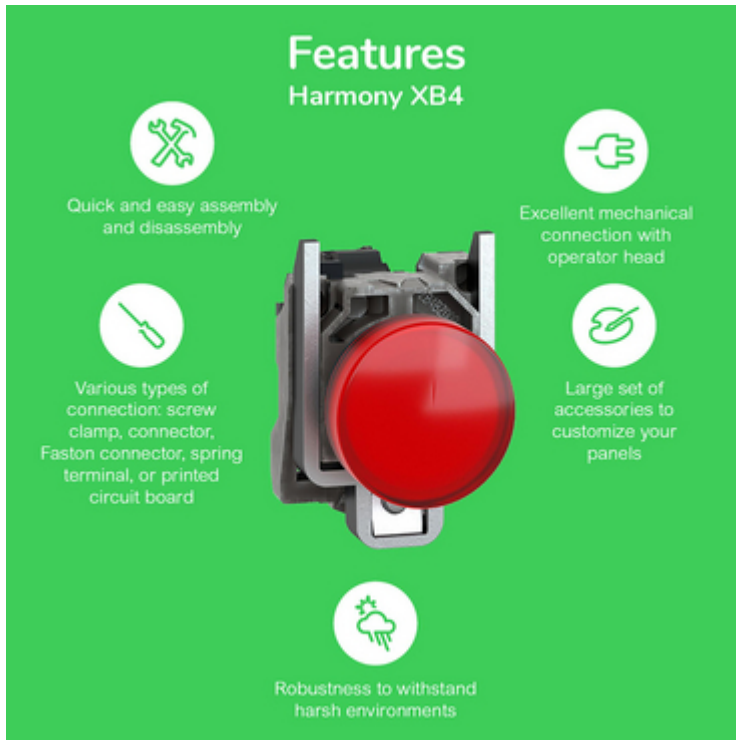

The infographic features a central image of a red Schneider XB4 terminal block. Surrounding this central image are five circular icons, each with a corresponding text description of a feature. The background is a solid green color.

Features Harmony XB4

- Quick and easy assembly and disassembly** (Icon: crossed wrench and screwdriver)
- Excellent mechanical connection with operator head** (Icon: hand holding a plug)
- Various types of connection: screw clamp, connector, Faston connector, spring terminal, or printed circuit board** (Icon: screwdriver)
- Large set of accessories to customize your panels** (Icon: plug with a slash through it)
- Robustness to withstand harsh environments** (Icon: lightning bolt and rain cloud)

Offer Marketing Illustration

Product benefits / Features

Technical Benefits

Harmony XB4

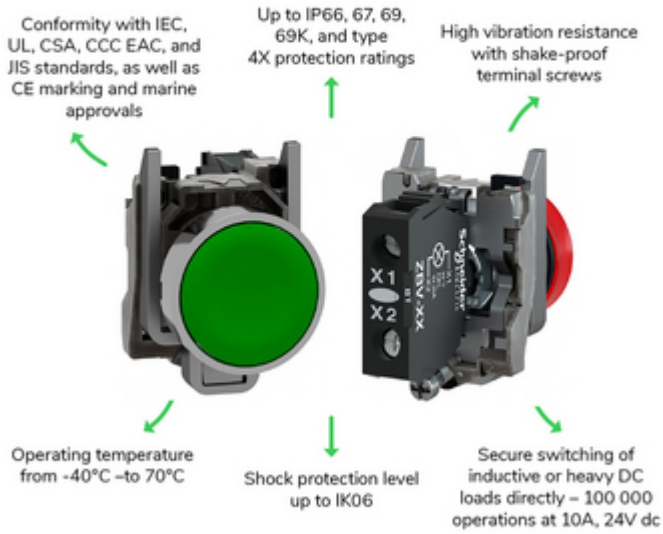

Image of product / Alternate images

Alternative

