

Wall mounted receptacle

Part number: 27004



MENNEKES
Elektrotechnik GmbH & Co. KG

Aloys-Mennekes-Straße 1
57399 Kirchhundem
GERMANY

www.MENNEKES.org

Product Description

- screw connection technology
- external fixing, prepared for internal fixing
- 15° inclination

Technical Details

Wall mounted receptacle	27004
Ampere	16A
Number of poles	5p
Clock position	6h
Nominal voltage AC	400V
Nominal frequency	50 - 60 Hz
Protection type IP	IP44
Contact carrier	standard
X-CONTACT	no
Connection	screw terminals
Contact screw drive	PZ2, slot
Screw drive external screws	PZ2, slot
Pilot contact	without pilot contact
Pilot contact switch	no
Cable entry at the top	1 x M25x1,5
Blind cable entry at the rear	no
Enclosure base can be turned 180°	no
Insertion direction	angled
Inclination	15°
Type of mounting	external fixing, prepared for internal fixing
Highly resistant to chemicals	no
Military version	no
Lockable	no
Tightening torque connection terminal for cable cross-section 1,0 - 1,5 mm ²	0.6 Nm
Tightening torque connection terminal for cable cross-section 2,5 - 4,0 mm ²	0.8 Nm

Wall mounted receptacle	27004
Tightening torque connection terminal for cable cross-section 6 - 10 mm ²	1.2 Nm
Strip length jacket	90 mm
Strip length PH + N solid conductor	8 - 10 mm
Strip length PE solid conductor	12 - 17 mm
Conductor cross-section min.	1.5 mm ²
Conductor cross-section max.	4 mm ²
Weight (net)	270 g
Packaging unit	10 pcs
Quantity per pallet	720 pcs
EAN / identification number	4015394287681

Permissible ambient conditions		
	Min.	Max.
Permissible ambient temperature	-25 °C	40 °C
Average temperature over 24 hours		35 °C

Material properties	
Base	PA6 light grey [similar RAL 7035]
Upper part	PA6 red [similar RAL 3013]
Front part	PA6 red [similar RAL 3013]
Hinged lid	PC red [similar RAL 3013]
External screws	steel galvanised

Material resistance

The material resistance overview can be found on the website in the section “Knowledge” - “Product knowledge” - “Materials”.

Material and environmental properties

RoHS 2011/65/EU incl. 2015/863/EU	✓
POP regulation (EU) 2019/1021	✓
Halogen-free	yes

Regulations and Standards

Norm	DIN EN IEC 60309-2
Declaration of Conformity	CE
Test label	CB Zertifikat, VDE, EAC, CQC

Dimensional Drawing

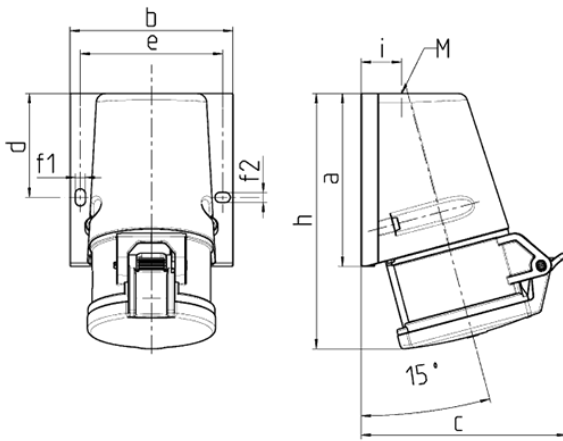

Drawing 1 MB 463	Amp. Poles	16			32		
		3	4	5	3	4	5
Dim. in mm	a	95	93	92.5	102	102	102
	b	73.5	87.5	87.5	94	94	94
	c	93	107.5	110	115.5	115.5	119.5
	d	55.5	55.5	55.5	62	62	62
	e	61	76	76	84	84	84
	f1	5.3	5.3	5.3	5.1	5.1	5.1
	f2	5.3	5.3	5.3	5.1	5.1	5.1
	h	139	139	136.5	160	160	156.5
	i	19.8	21.5	21.5	26.5	26.5	26.5
	M	M20x	M25x	M25x	M25x	M32x	M32x
Terminal for cond. cross section (mm ²) min.-max.		1.5	1.5	1.5	1.5	1.5	1.5
		1.5	1.5	1.5	2.5	2.5	2.5
		-4	-4	-4	-6	-6	-6