

# SPARE PARTS

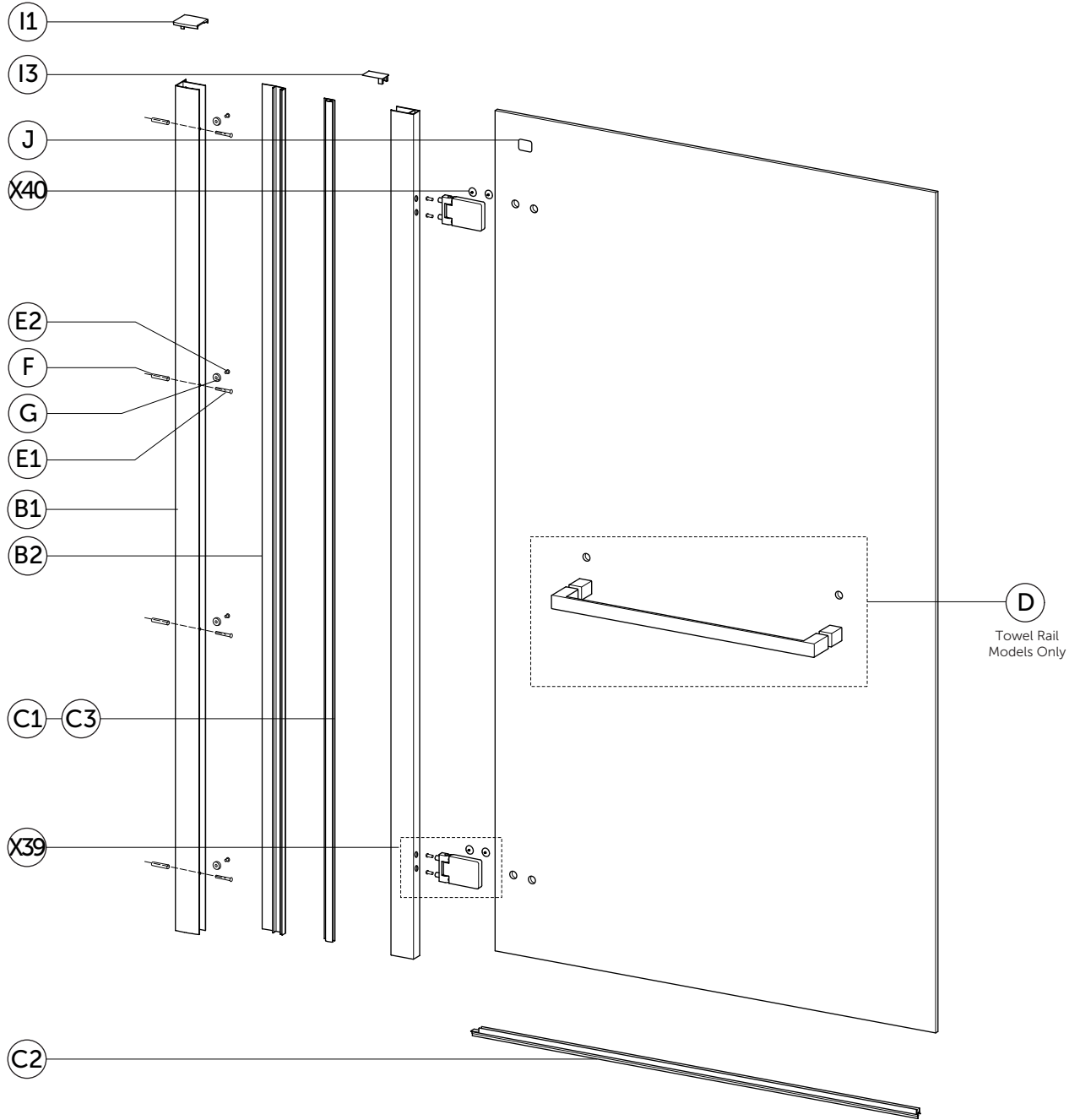







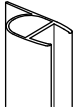
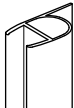
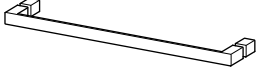

Single Panel Hinged Bath Screen

I.LIFE

T4889	T4888	T4885	T4884
900 LH Including towel rail	900 RH Including towel rail	815 LH	815 RH

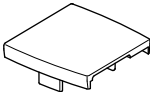
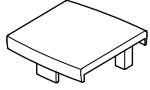

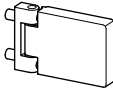
Item	ERP Code	Drawing	Description	Remark	SKU
B1	LY-JC310-01		Wall profile (UK - 25mm Adjustment)	length 1500mm, with 8 holes pre-drilled	TR031EO
B2	LY-JC310-02		Wall cover profile (UK - 25mm Adjustment)	length 1500mm	TR032EO
C2	308-616		1 Panel Screen Bottom Seal	length 845mm	TR09367

Item	ERP Code	Drawing	Description	Remark	SKU
C1	308-614		1 Panel Screen Vertical Seal - LH (notched at one end)	(Pair) Length = 1500mm	TR09467
C3			1 Panel Screen Vertical Seal - RH (notched at one end)		
D	LY-MB817-53		Towel Rail Assembly	Complete including screws, covers etc.	TR133AA
E1			Installation pack fixing wall jamb on wall	TCB 3.9X30 : x8pcs	TR03667
E2				TCB 3.9X9 : x8pcs	
F				wall plug: x8pcs	
G		LY-JC200-10			
I3	LY-JC310-50		cover for vertical profile (UK - 25mm Adjustment)	1pc	TR114AA
I1	LY-JC310-53		Top cover for wall profile LH (UK - 25mm Adjustment)	1pc	TR115AA
I2	LY-JC310-52		Top cover for wall profile RH (UK - 25mm Adjustment)	1pc	TR116AA
J			S.S. sticker with positioning template		KV29567
X39	LY-MB814-05		Pivoting Hinge Assembly	Complete including screws, covers etc..	TR101AA
X40	LY-MB815-07		Flush Cover Cap for Hinges & Pivots		TR159AA

Ideal Standard International NV  
Corporate Village – Gent Building  
Da Vincilaan 2  
B1935 – Zaventem  
Belgium

**BE** +32 (02) 325 66 33  
**BG** +359 675 30362  
**DE** +49 (0)228 521 580  
**EG** +202 26969700  
**FR** +33 (0)1 49 38 28 00  
**GB** 01482 496 318

**GR** +30 210 67 90 810  
**HR** +38591 22 99 304  
**HU** +36 30 6991 594  
**IT** 800 652 290  
**ME** +971 4 804 2400  
**NL** +31 (077) 355 08 08

**PL** +48 71 7868 301/302  
**RO** +40 21 3223 201/202  
**SI** 00386 59 919040  
**TR** +90 216 314 87 87  
**UA** +359 675 30468  
**AL/XK/BA** +359 887 709 696

**CZ/SK** +420 417 592 179  
**DK/NO/SE** +45 75 84 10 10  
**ES/PT** +34 93 561 80 00  
**LV/LT/EE** +371 673 57 792  
**RS/MK/ME** +381 11 713 80 58  
**RU/MD** +7 495 669 23 11