

Data Sheet | Item Number: 216-301

Ferrule; Sleeve for 0.25 mm² / AWG 24; insulated; electro-tin plated; yellow

<https://www.wago.com/216-301>



Color: ■ yellow

Similar to illustration

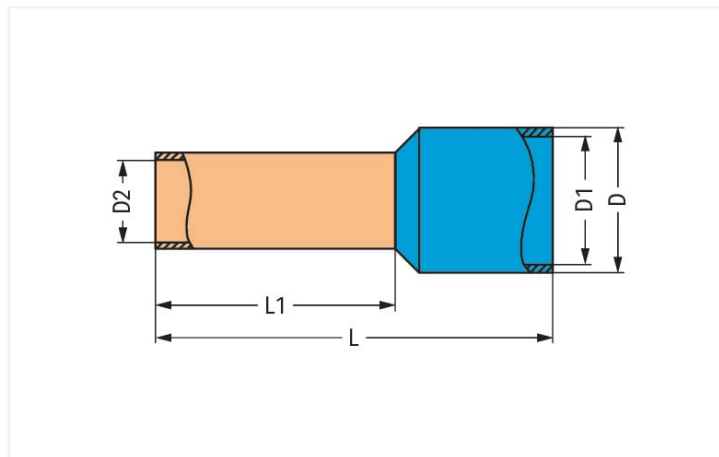

Dimensions in mm

Technical data

Sleeve cross-section (AWG)	24 AWG
Sleeve for	0.25 mm ²

Connection data

Strip length	9 mm / 0.35 inches
--------------	--------------------

Physical data

Length	12 mm
Crimp length (length of sleeve)	8 mm
Diameter	2.3 mm
Inner Diameter plastic collar	1.8 mm
Diameter crimp sleeve inside	0.5 mm

Material data

Color	yellow
Fire load	0.001 MJ
Weight	0.1 g

Commercial data

Product Group	2 (Terminal Block Accessories)
eCl@ss 10.0	27-40-02-01
eCl@ss 9.0	27-40-02-01
ETIM 8.0	EC000005
ETIM 7.0	EC000005
PU (SPU)	1000 pcs
Packaging type	Box
Country of origin	DE
GTIN	4017332277396
Customs tariff number	85369010000

Environmental Product Compliance

RoHS Compliance Status	Compliant, No Exemption
------------------------	-------------------------

Downloads

Environmental Product Compliance

Compliance Search	
Environmental Product Compliance 216-301	↓

Documentation

Bid Text			
216-301	11.09.2017	doc 23.50 KB	↓
216-301	19.02.2019	xml 2.80 KB	↓

Installation Notes

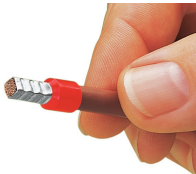

A perfect gas-tight crimp – both electrical-ly and mechanically reliable