

Data Sheet | Item Number: 721-208/037-000/035-000

1-conductor female connector; CAGE CLAMP®; 2.5 mm²; Pin spacing 7.5 mm; 8-pole; 100% protected against mismatching; Lateral locking levers; Strain relief plate; 2,50 mm²; light gray

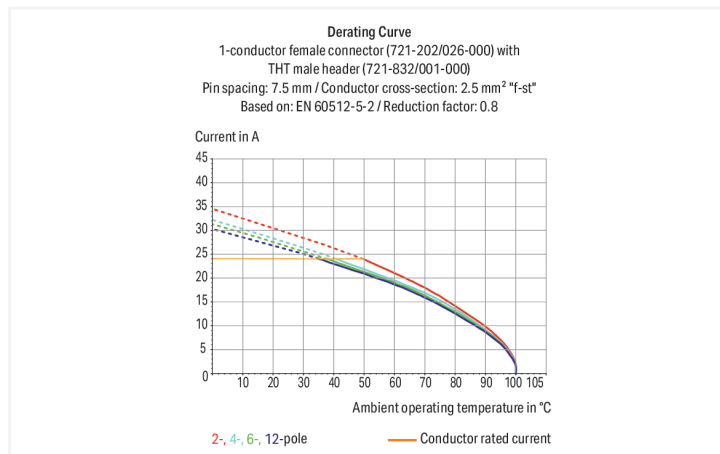

<https://www.wago.com/721-208/037-000/035-000>



Color: ■ light gray

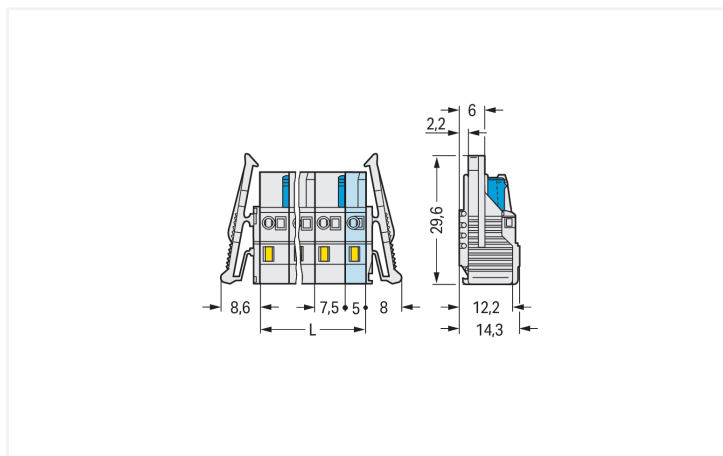

Dimensions in mm

L = (pole no. - 1) x pin spacing + 5 mm

Female connector, 721 Series, CAGE CLAMP®

This female connector (item number 721-208/037-000/035-000) simplifies electrical installations. Conductors can only be connected to this female connector if their strip length is between 8 and 9 mm. This product features one conductor terminal and utilizes CAGE CLAMP®. Our CAGE CLAMP® connection provides a secure and maintenance-free way to connect all types of conductors. You do not need to prepare the conductor in any way, such as crimping ferrules. Dimensions: (74.1 x 14.3 x 64.6) mm (width x height x depth). This female connector is suitable for conductor cross sections ranging from 0.08 mm² to 2.5 mm².

Tin is used for coating the contact surfaces. The strain relief plate is a safety precaution for connected conductors that also makes cables easier to handle..

Notes

Safety Information

The MCS – MULTI CONNECTION SYSTEM includes connectors without breaking capacity in accordance with DIN EN 61984. When used as intended, these connectors must not be connected/disconnected when live or under load. When used as intended, these connectors must not be connected/disconnected when live or under load. The circuit design should ensure header pins, which can be touched, are not live when unmated.

Variants:

Other pole numbers
Gold-plated or partially gold-plated contact surfaces
Other versions (or variants) can be requested from WAGO Sales or configured at <https://configurator.wago.com/>.

Electrical data

Ratings per IEC/EN 60664-1				Approvals per UL 1059			
	III	III	II	Use group	B	C	D
Overvoltage category	III	III	II	Rated voltage	300 V	-	300 V
Pollution degree	3	2	2	Rated current	15 A	-	10 A
Nominal voltage	500 V	630 V	1000 V				
Rated impulse withstand voltage	6 kV	6 kV	6 kV				
Rated current	16 A	16 A	16 A				

Approvals per UL 1977	
Rated voltage	600 V
Rated current	15 A

Approvals per CSA			
Use group	B	C	D
Rated voltage	300 V	-	300 V
Rated current	15 A	-	10 A

Connection Data

Clamping units	8
Total number of potentials	8
Number of connection types	1
Number of levels	1

Connection 1	
Connection technology	CAGE CLAMP®
Actuation type	Operating tool
Actuation direction 1	Operation parallel to conductor entry
Actuation direction 2	Operation perpendicular to conductor entry
Solid conductor	0.08 ... 2.5 mm ² / 28 ... 12 AWG
Fine-stranded conductor	0.08 ... 2.5 mm ² / 28 ... 12 AWG
Fine-stranded conductor; with insulated ferrule	0.25 ... 1.5 mm ²
Fine-stranded conductor; with uninsulated ferrule	0.25 ... 2.5 mm ²
Strip length	8 ... 9 mm / 0.31 ... 0.35 inches
Pole number	8
Conductor entry direction to mating direction	0°

Physical data

Pin spacing	7.5 mm / 0.295 inches
Width	74.1 mm / 2.917 inches
Height	14.3 mm / 0.563 inches
Depth	64.6 mm / 2.543 inches

Mechanical data

Variable coding	Yes
Anti-rotation protection	Yes

Plug-in connection

Contact type (pluggable connector)	Female connector/socket
Connector (connection type)	for conductor
Mismatching protection	Yes
Locking of plug-in connection	Locking lever
Strain relief	Strain relief plate

Material data

Note (material data)	Information on material specifications can be found here
Color	light gray
Material group	I
Insulation material (main housing)	Polyamide (PA66)
Flammability class per UL94	V0
Clamping spring material	Chrome-nickel spring steel (CrNi)
Contact material	Copper alloy
Contact Plating	Tin
Fire load	0.395 MJ
Weight	20.7 g

Environmental requirements

Limit temperature range	-60 ... +100 °C
Processing temperature	-35 ... +60 °C

Commercial data

Product Group	3 (Multi Conn. System)
PU (SPU)	50 pcs
Packaging type	Box
Country of origin	DE
GTIN	4044918381680
Customs tariff number	85366990990

Product Classification

UNSPSC	39121409
eCl@ss 10.0	27-44-03-09
eCl@ss 9.0	27-44-03-09
ETIM 9.0	EC002638
ETIM 10.0	EC002638
ECCN	NO US CLASSIFICATION

Environmental Product Compliance

RoHS Compliance Status	Compliant, No Exemption
------------------------	-------------------------

Approvals / Certificates

General approvals



Approval	Standard	Certificate Name
CSA CSA Group	C22.2	1466354

Downloads

Environmental Product Compliance

Compliance Search



Documentation

Additional Information

Technical Section	03.04.2019	pdf 2027.26 KB	
-------------------	------------	-------------------	--

1 Compatible Products

1.1 System counterpart

1.1.1 Male connector/plug



Item No.: 723-608
 1-conductor male connector; CAGE CLAMP®; 2.5 mm²; Pin spacing 7.5 mm; 8-pole; 100% protected against mismatching; 2,50 mm²; light gray



Item No.: 721-838/001-000
 THT male header; 1.0 x 1.0 mm solder pin; angled; 100% protected against mismatching; Pin spacing 7.5 mm; 8-pole; light gray



Item No.: 721-238/001-000
 THT male header; 1.0 x 1.0 mm solder pin; straight; 100% protected against mismatching; Pin spacing 7.5 mm; 8-pole; light gray

1.2 Optional Accessories

1.2.1 Cover

1.2.1.1 Cover



Item No.: 231-668

Lockout caps; for covering unused clamping units; gray

1.2.2 Ferrule

1.2.2.1 Ferrule



Item No.: 216-301

Ferrule; Sleeve for 0.25 mm² / AWG 24; insulated; electro-tin plated; yellow



Item No.: 216-302

Ferrule; Sleeve for 0.34 mm² / 22 AWG; insulated; electro-tin plated; light turquoise



Item No.: 216-201

Ferrule; Sleeve for 0.5 mm² / 20 AWG; insulated; electro-tin plated; electrolytic copper; acc. to DIN 46228, Part 4/09.90; white



Item No.: 216-241

Ferrule; Sleeve for 0.5 mm² / 20 AWG; insulated; electro-tin plated; electrolytic copper; gastight crimped; acc. to DIN 46228, Part 4/09.90; white



Item No.: 216-141

Ferrule; Sleeve for 0.5 mm² / 20 AWG; un-insulated; electro-tin plated; electrolytic copper; gastight crimped; acc. to DIN 46228, Part 1/08.92



Item No.: 216-101

Ferrule; Sleeve for 0.5 mm² / AWG 22; un-insulated; electro-tin plated; silver-colored



Item No.: 216-242

Ferrule; Sleeve for 0.75 mm² / 18 AWG; insulated; electro-tin plated; electrolytic copper; gastight crimped; acc. to DIN 46228, Part 4/09.90; gray



Item No.: 216-262

Ferrule; Sleeve for 0.75 mm² / 18 AWG; insulated; electro-tin plated; electrolytic copper; gastight crimped; acc. to DIN 46228, Part 4/09.90; gray



Item No.: 216-202

Ferrule; Sleeve for 0.75 mm² / 18 AWG; insulated; electro-tin plated; gray



Item No.: 216-142

Ferrule; Sleeve for 0.75 mm² / 18 AWG; un-insulated; electro-tin plated; electrolytic copper; gastight crimped; acc. to DIN 46228, Part 1/08.92



Item No.: 216-102

Ferrule; Sleeve for 0.75 mm² / AWG 20; un-insulated; electro-tin plated; silver-colored



Item No.: 216-243

Ferrule; Sleeve for 1 mm² / AWG 18; insulated; electro-tin plated; electrolytic copper; gastight crimped; acc. to DIN 46228, Part 4/09.90; red



Item No.: 216-263

Ferrule; Sleeve for 1 mm² / AWG 18; insulated; electro-tin plated; electrolytic copper; gastight crimped; acc. to DIN 46228, Part 4/09.90; red



Item No.: 216-203

Ferrule; Sleeve for 1 mm² / AWG 18; insulated; electro-tin plated; red



Item No.: 216-103

Ferrule; Sleeve for 1 mm² / AWG 18; un-insulated; electro-tin plated



Item No.: 216-143

Ferrule; Sleeve for 1 mm² / AWG 18; un-insulated; electro-tin plated; electrolytic copper; gastight crimped; acc. to DIN 46228, Part 1/08.92



Item No.: 216-204

Ferrule; Sleeve for 1.5 mm² / AWG 16; insulated; electro-tin plated; black



Item No.: 216-244

Ferrule; Sleeve for 1.5 mm² / AWG 16; insulated; electro-tin plated; electrolytic copper; gastight crimped; acc. to DIN 46228, Part 4/09.90; black



Item No.: 216-264

Ferrule; Sleeve for 1.5 mm² / AWG 16; insulated; electro-tin plated; electrolytic copper; gastight crimped; acc. to DIN 46228, Part 4/09.90; black



Item No.: 216-284

Ferrule; Sleeve for 1.5 mm² / AWG 16; insulated; electro-tin plated; electrolytic copper; gastight crimped; acc. to DIN 46228, Part 4/09.90; black



Item No.: 216-144

Ferrule; Sleeve for 1.5 mm² / AWG 16; un-insulated; electro-tin plated; electrolytic copper; gastight crimped; acc. to DIN 46228, Part 1/08.92; silver-colored



Item No.: 216-104

Ferrule; Sleeve for 1.5 mm² / AWG 16; un-insulated; electro-tin plated; silver-colored



Item No.: 216-106

Ferrule; Sleeve for 2.5 mm² / AWG 14; un-insulated; electro-tin plated; silver-colored

1.2.3 Insulation stop

1.2.3.1 Insulation stop



Item No.: 231-673

Insulation stop; 0.08-0.2 mm² / 0.2 mm² "s"; white



Item No.: 231-674

Insulation stop; 0.25 - 0.5 mm²; light gray



Item No.: 231-675

Insulation stop; 0.75 - 1 mm²; dark gray

1.2.4 Marking

1.2.4.1 Marking strip



Item No.: 210-331/750-202

Marking strips; as a DIN A4 sheet; MARKED; 1-16 (100x); Height of marker strip: 2.3 mm/0.091 in; Strip length 182 mm; Horizontal marking; Self-adhesive; white



Item No.: 210-332/750-020

Marking strips; as a DIN A4 sheet; MARKED; 1-20 (80x); Height of marker strip: 3 mm; Strip length 182 mm; Horizontal marking; Self-adhesive; white

1.2.5 Test and measurement

1.2.5.1 Testing accessories



Item No.: 210-136

Test plug; 2 mm Ø; with 500 mm cable; red



Item No.: 231-662

Test plugs for female connectors; for 7.5 mm and 7.62 mm pin spacing; 2,50 mm²; light gray

1.2.6 Tool

1.2.6.1 Operating tool



Item No.: 231-291

Operating tool; made of insulating material; 1-way; loose; red



Item No.: 231-131

Operating tool; made of insulating material; 1-way; loose; white

Installation Notes

Conductor termination

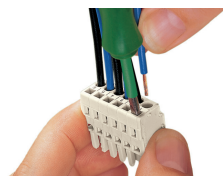

Inserting a conductor via 3.5 mm screwdriver – CAGE CLAMP® actuation parallel to conductor entry.

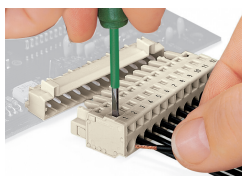

Inserting a conductor via 3.5 mm screwdriver – CAGE CLAMP® actuation perpendicular to conductor entry.

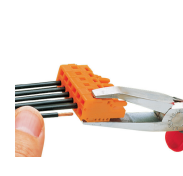
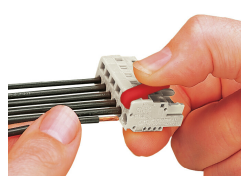

Inserting a conductor via operating tool.

Coding



Coding a female connector by removing coding finger(s).

Testing

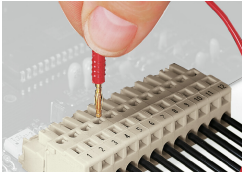

Testing perpendicular to conductor entry with 2 or 2.3 mm Ø test plug – female connector with CAGE CLAMP® – via integrated test ports

Installation



Male connector with strain relief plate



Strain relief housing shown with a male connector equipped with CAGE CLAMP®