

Data Sheet | Item Number: 216-205

Ferrule; Sleeve for 2.08 mm² / AWG 14; insulated; electro-tin plated; yellow

<https://www.wago.com/216-205>



Color: ■ yellow

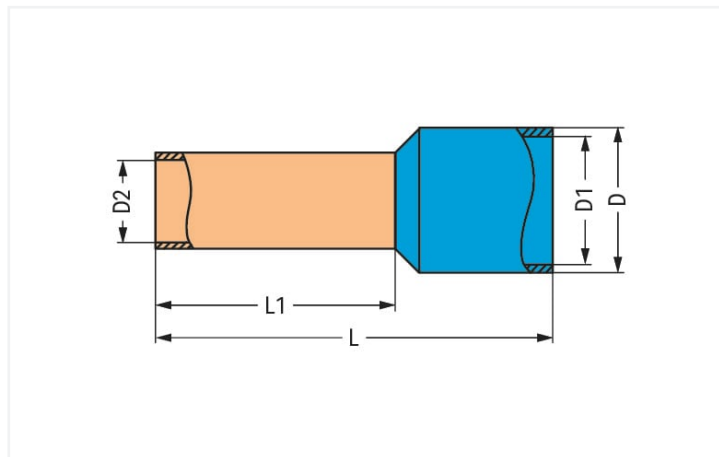

Dimensions in mm

Technical data

Sleeve cross-section (AWG)	14 AWG
Sleeve for	2.08 mm ²

Connection data

Strip length	10 mm / 0.39 inches
--------------	---------------------

Physical data

Length	15 mm
Crimp length (length of sleeve)	8 mm
Diameter	4.8 mm
Inner Diameter plastic collar	4.2 mm
Diameter crimp sleeve inside	2.05 mm

Material data

Color	yellow
Fire load	0.002 MJ
Weight	0.1 g

Commercial data

Product Group	2 (Terminal Block Accessories)
eCl@ss 10.0	27-40-02-01
eCl@ss 9.0	27-40-02-01
ETIM 8.0	EC000005
ETIM 7.0	EC000005
PU (SPU)	1000 (100) pcs
Packaging type	Box
Country of origin	DE
GTIN	4017332277501
Customs tariff number	85369010000

Environmental Product Compliance

RoHS Compliance Status	Compliant, No Exemption
------------------------	-------------------------

Downloads

Environmental Product Compliance

Compliance Search	
Environmental Product Compliance 216-205	↓

Documentation

Bid Text			
216-205	19.02.2019	xml 2.80 KB	↓
216-205	11.09.2017	doc 23.50 KB	↓

Installation Notes



A perfect gas-tight crimp – both electrical-ly and mechanically reliable