

# Product data sheet Spirotech

## Product name

**SpiroVent -DN125 -Flange**

## Product properties

A steel (microbubble) deaerator for standard flow rate (1.5 m/s) with a DN50 - DN300 PN16 flange connection

- Removes all circulating air and microbubbles effectively
- Removes trapped air when installed at the correct location
- Greatly reduces the need for manual venting
- Applicable with 50/50 Glycol / Water (Volume)
- Constant low-pressure drop
- No unnecessary shutdown
- PN16 Flange connections
- Connection diameters from DN50 to DN300, larger diameters available on request
- Exceptional guarantee

## Article number

**BA125F**

## Product image



## Product dimensions

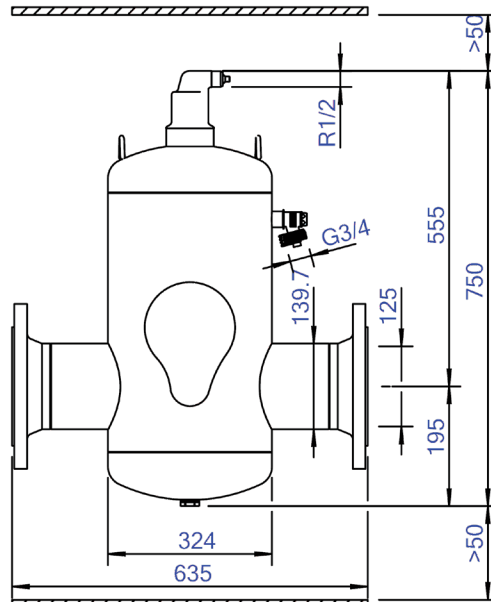

# Product data sheet Spirotech

## ETIM product data

Housing material	Steel
With drain tap	No
Housing material quality	St 37 (1.0254)
Backwash filter	No
Medium temperature (continuous)	0 - 110 °C
Max. operating pressure	10 bar
Kvs value	350.7
Variable flow direction	Yes
With insulation	No
Separator type	Air
Connection	Flange
Model	Horizontal
Nominal diameter	DN 125
Max. glycol mixture	50 %
Suitable for heating	Yes
Suitable for cooling	Yes

Construction length	635 mm
Article compression class	PN 10
Surface protection	Lacquered
Suitable for open system	No
Suitable for closed system	Yes
Suitable for solar	No
With dismountable filter	No
Filter volume	50 l
Magnet operating principle	No
With automatic de-aerator	Yes
With couplers	No
Inlet/outlet offset distance	0 mm
Material of connection	Steel
Flow-through capacity	0 - 72 m <sup>3</sup> /h
Flange standard	DIN

### Disclaimer

This product sheet has been compiled with the greatest possible care. Nevertheless, it may contain errors or omissions. For the most current and correct information we refer you to our website.

