













33 525 809 Product version from 3/13/2017



- 123mm projection
- pivotable spout 360°
- circular, air-enriched flow
- height of mixer 274 mm
- height up to aerator 220 mm
- hole diameter 35 mm
- 2x screw-in M 8 x 1 pressure hose, leak-tested
- max. flow 5.7 l/min
- lead-free
- This product can help a building meet the requirements of Green Building Rating Systems, e.g. LEED®, BREEAM®, DGNB
- WRAS

	Chrome	33 525 809-00
	Brushed Platinum	33 525 809-06
	Platinum	33 525 809-08
	Dark Chrome	33 525 809-19
	Brushed Durabrass (23kt Gold)	33 525 809-28
	Brushed Gold (PVD)	33 525 809-37
	Brushed Dark Brass (PVD)	33 525 809-39
	Brushed Bronze (PVD)	33 525 809-42
	Brushed Dark Bronze (PVD)	33 525 809-43
	Brushed Champagne (22kt Gold)	33 525 809-46
	Champagne (22kt Gold)	33 525 809-47
	Brushed Dark Platinum	33 525 809-99

33 525 809 Product version from 3/13/2017

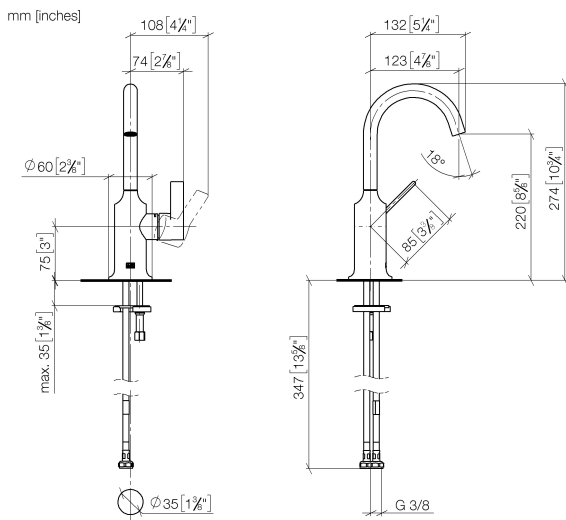

Flow rate chart

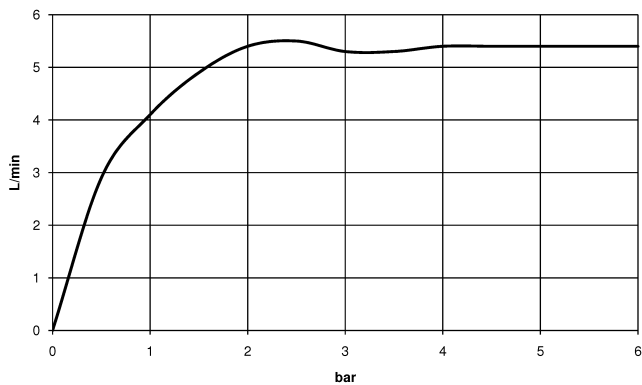

Codes & Standards

DIN 4109

Executive Order
no. 1007

ISO 3822

Scottish Water
Byelaws

UK Water Supply
Regulations

Ü-Zeichen



VAIA Single-lever basin mixer without pop-up waste - Chrome

VAIA

33 525 809 Product version from 3/13/2017

Certificates and sustainability

WRAS_240702

GDV_0400

LGA_29

EPD-DOR-20230287
-IBA1-EN
Environmental.prod
uct-declarat

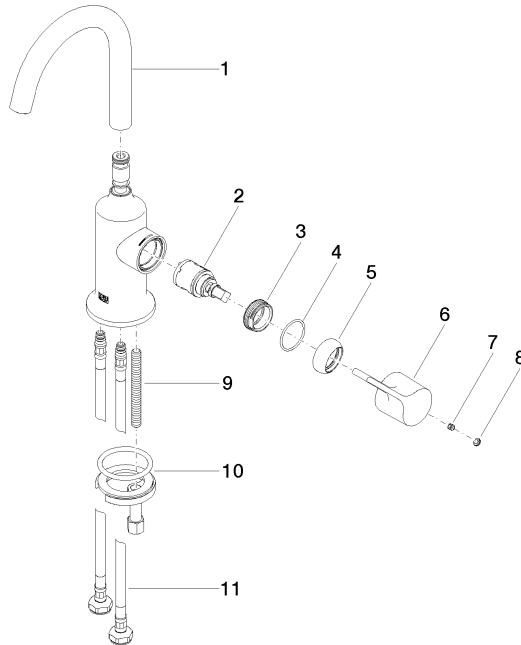

Spare parts list

No.	Item Number	Name	Quantity used	Delivery time	
	10	04 30 11 038 00 90	Mounting with O-ring Ø40 x 4mm Ø 52 x 1,5 mm -	1.00	14
	9	09 31 11 011 90	Mounting Threaded bolt M8 x 80 mm -	1.00	14
	1	90 28 22 312 00-00	Spout 123 mm, 5,68 l/min. - Chrome	1.00	20
	2	90 15 05 042 00 90	Cartridge Ø 25 x 52 mm -	1.00	14
	5	09 28 30 021-00	Cover Ø 32 x 11 mm - Chrome	1.00	20
	7	90 31 11 030 00 90	Mounting Threaded pin with hexagon socket with cup point M5 x 5 mm -	1.00	14
	3	09 24 04 266 90	Mounting Ø 28 x 10,8 mm -	1.00	14
	8	90 31 20 087 00-00	Plug with O-ring Ø 7 x 2,1 mm - Chrome	1.00	20
	4	09 14 10 091 90	O-Ring NBR 70 26,5 x 1,72 mm -	1.00	14
	11	04 30 04 100 00 90	High pressure hose M8x1 x 3/8" x 420 mm -	2.00	14
	6	90 20 80 070 00-00	Lever 37 x 34 x 107 mm - Chrome	1.00	20