

Color: ■ light gray

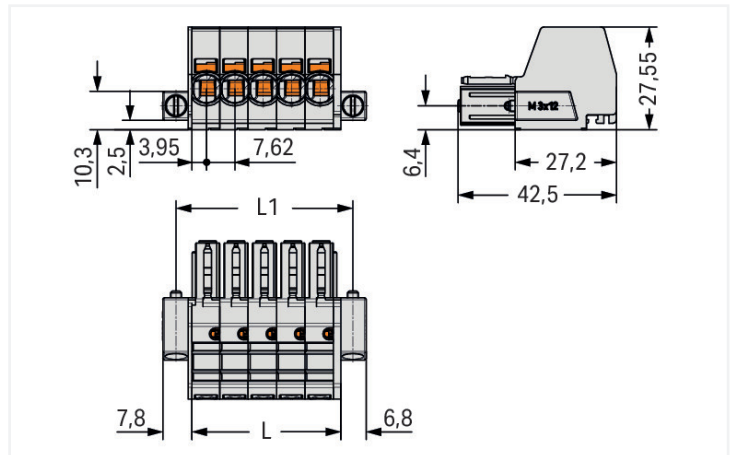
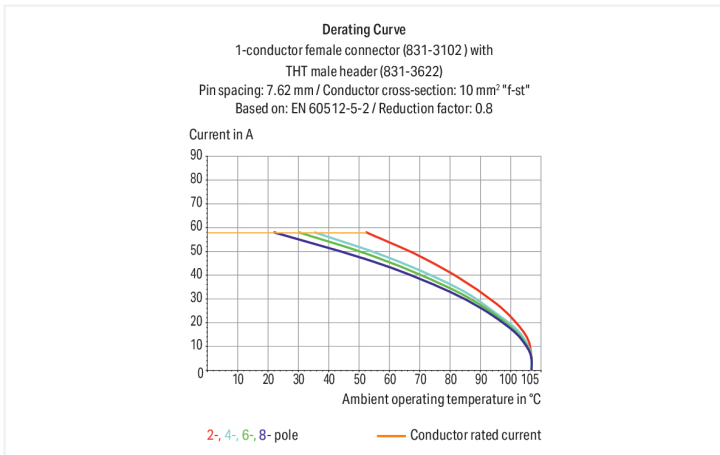
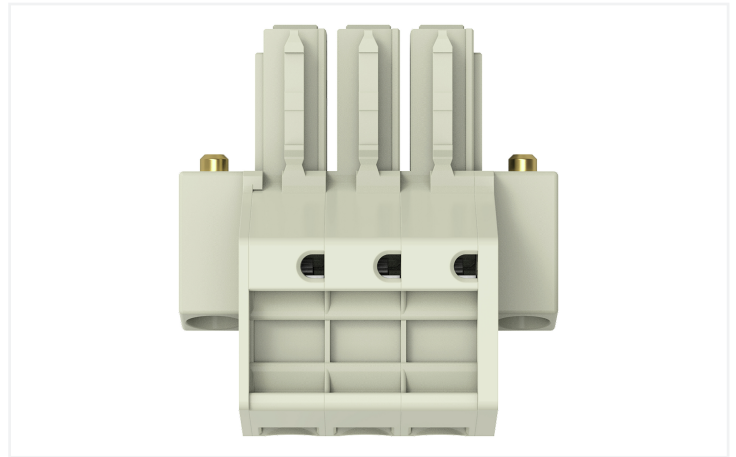
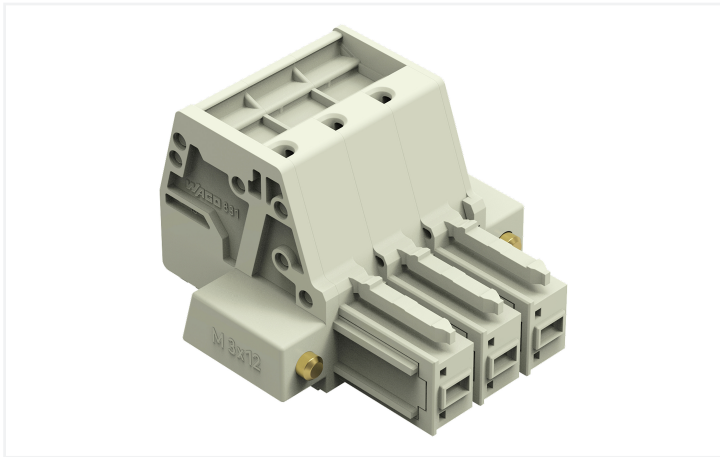

Female connector, 831 Series, 0° conductor exit to connection direction

This female connector (item number 831-3103/107-000) simplifies electrical installations. Strip lengths must be between 13 and 15 mm when connecting conductors to this female connector. This product features one conductor terminal and utilizes Push-in CAGE CLAMP®. Push-in CAGE CLAMP® technology provides a universal connection solution for any type of conductor. It allows both solid and fine-stranded conductors with ferrules to be inserted directly into the clamping point without the need for tools. The dimensions are (39.4 x 27.6 x 42.5) mm (width x height x depth). Depending on the

conductor type, this female connector is ideal for conductor cross sections ranging from 0.5 mm² to 10 mm².

The contact surface is coated with tin.

Notes	
Safety Information	The MCS – MULTI CONNECTION SYSTEM includes connectors without breaking capacity in accordance with DIN EN 61984. When used as intended, these connectors must not be connected/disconnected when live or under load. When used as intended, these connectors must not be connected/disconnected when live or under load. The circuit design should ensure header pins, which can be touched, are not live when unmated.
Variants:	Other pole numbers Other versions (or variants) can be requested from WAGO Sales or configured at https://configurator.wago.com/ .

Electrical data

Ratings per	IEC/EN 60664-1			Approvals per	UL 1059		
Overvoltage category	III	III	II	Use group	B	C	D
Pollution degree	3	2	2	Rated voltage	-	600 V	-
Nominal voltage	800 V	1000 V	1000 V	Rated current	-	42 A	-
Rated impulse withstand voltage	8 kV	8 kV	8 kV				
Rated current	41 A	41 A	41 A				

Approvals per	CSA		
Use group	B	C	D
Rated voltage	-	600 V	-
Rated current	-	41 A	-

Connection Data

Clamping units	3	Connection 1	
Total number of potentials	3	Connection technology	Push-in CAGE CLAMP®
Number of connection types	1	Actuation type	Operating tool
Number of levels	1	Actuation direction 1	Operation parallel to conductor entry
		Solid conductor	0.5 ... 10 mm ² / 20 ... 8 AWG
		Fine-stranded conductor	0.5 ... 10 mm ² / 20 ... 8 AWG
		Fine-stranded conductor; with insulated ferrule	0.5 ... 6 mm ²
		Fine-stranded conductor; with uninsulated ferrule	0.5 ... 6 mm ²
		Strip length	13 ... 15 mm / 0.51 ... 0.59 inches
		Pole number	3
		Conductor entry direction to mating direction	0°

Physical data

Pin spacing	7.62 mm / 0.3 inches
Width	39.4 mm / 1.550 inches
Height	27.6 mm / 1.087 inches
Depth	42.5 mm / 1.673 inches

Mechanical data

Variable coding	Yes
Anti-rotation protection	Yes

Plug-in connection

Contact type (pluggable connector)	Female connector/socket
Connector (connection type)	for conductor
Mismating protection	Yes
Locking of plug-in connection	Screw flange

Material data

Note (material data)	Information on material specifications can be found here
Color	light gray
Material group	I
Insulation material (main housing)	Polyamide (PA66)
Flammability class per UL94	V0
Clamping spring material	Chrome-nickel spring steel (CrNi)
Material of the additional spring for socket contact	Chrome-nickel spring steel (CrNi)
Contact material	Electrolytic copper (E _{Cu})
Contact Plating	Tin
Fire load	0.39 MJ
Weight	26.2 g

Environmental requirements

Limit temperature range	-60 ... +105 °C
Processing temperature	-35 ... +60 °C

Commercial data

PU (SPU)	24 pcs
Packaging type	Box
Country of origin	PL
GTIN	4066966779684
Customs tariff number	85366990990

Product Classification

UNSPSC	39121409
ETIM 9.0	EC001284
ETIM 10.0	EC001284
ECCN	NO US CLASSIFICATION

Environmental Product Compliance

RoHS Compliance Status	Compliant, No Exemption
------------------------	-------------------------

Approvals / Certificates

General approvals



Approval	Standard	Certificate Name
CB DEKRA Certification B.V.	IEC 61984	NL-61360/M1
KEMA/KEUR DEKRA Certification B.V.	EN 61984	71-116057
UR Underwriters Laboratories Inc.	UL 1059	UL-US-2426356-0

Downloads

Environmental Product Compliance

Compliance Search

Environmental Product
Compliance
831-3103/107-000



Documentation

Additional Information

Technical Section

03.04.2019

pdf

2027.26 KB



CAD/CAE-Data

CAD data

2D/3D Models
831-3103/107-000



CAE data

ZUKEN Portal
831-3103/107-000



1 Compatible Products

1.1 System counterpart

1.1.1 Male connector/plug



[Item No.: 831-3203/109-000](#)

1-conductor male connector; Push-in CA-GE CLAMP®; 10 mm²; Pin spacing 7.62 mm; 3-pole; 100% protected against mismatching; Threaded flange; 10,00 mm²; light gray



[Item No.: 831-3623/108-000](#)

THT male header; 1.0 x 1.2 mm solder pin; angled; 100% protected against mismatching; Threaded flange; Pin spacing 7.62 mm; 3-pole; light gray



[Item No.: 831-3603/108-000](#)

THT male header; 1.0 x 1.2 mm solder pin; straight; 100% protected against mismatching; Threaded flange; Pin spacing 7.62 mm; 3-pole; light gray

1.2 Optional Accessories

1.2.1 Ferrule

1.2.1.1 Ferrule



Item No.: 216-101

Ferrule; Sleeve for 0.5 mm² / AWG 22; un-insulated; electro-tin plated; silver-colored

Item No.: 216-102

Ferrule; Sleeve for 0.75 mm² / AWG 20; un-insulated; electro-tin plated; silver-colored

1.2.2 Strain relief

1.2.2.1 Strain relief plate



Item No.: 831-506

Strain relief plate; for female and male connectors; 51 mm wide; 1 part; Pin spacing 7.62 mm; light gray

Installation Notes

Conductor termination

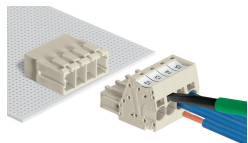

Inserting fine-stranded conductors via (5.5 x 0.8) mm screwdriver.

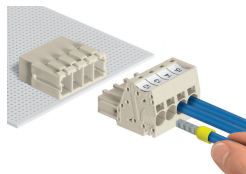

Solid and ferruled conductors are terminated by simply pushing them into unit.

Testing

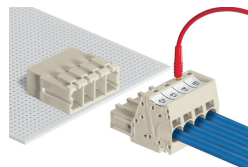

Testing with 2 mm Ø test plug.

Coding

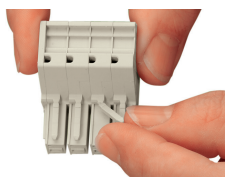

Break or cut off coding pin from female connector.

Marking



Direct marking of female and male connectors

MCS MAXI male and female connectors can also be marked via Mini-WSB or WMB markers.