

Maxi Accu Geocoil - MAGC

600-1000 l.

EN



SAFETY INFORMATION
O&M INFORMATION
INSTALLATION MANUAL

Manufactured by OSO Hotwater AS
Industriveien 1 - 3300 Hokksund - Norway
Tel: +47 32 25 00 00 / E-mail: oso@oso.no
www.osohotwater.com

11002277-146045-07 - 03-2023

OSO
HOT WATER

CONTENTS

1. Safety instructions	3
1.1 General information.....	3
1.2 Safety instructions for users.....	4
1.3 Safety instructions for installers.....	4
2. Product description	5
2.1. Product identification.....	5
2.2. Intended use.....	5
2.3 CE marking.....	5
2.4 Technical data.....	5
3. Installation instructions	6
3.1. Products covered by these instructions.....	6
3.2. Included in delivery.....	6
3.3. Product dimensions.....	6
3.4. Requirements for installation location ..	7
3.5. Pipe installation.....	8
4. Initial commissioning	10
4.1. Filling with water.....	10
4.2. Control points.....	10
4.4. Emptying of water.....	10
4.5. Handover to end-user.....	10
5. User guide	10
5.1. Settings.....	10
5.2 Annual inspection.....	10
5.3 Maintenance.....	10
6. Troubleshooting	10
6.1. Faults and fixes.....	10
7. Warranty conditions	11
7.1. Warranty and registration.....	11
7.2. Customer service.....	11
8. Removing the product	11
8.1. Removal.....	11
8.2. Returns scheme.....	11

1. SAFETY INSTRUCTIONS

1.1 General information



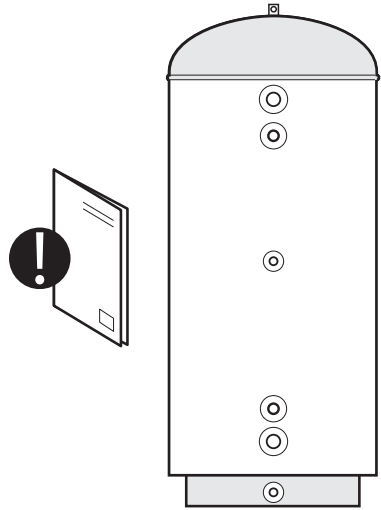

- Read the following safety instructions carefully before installing, maintaining or adjusting the buffer tank.
- Personal injury or material damage may result if the product is not installed or used in the intended manner.
- Keep this manual and other relevant documents where they are accessible for future reference.
- The manufacturer assumes compliance (by the end-user) with the safety, operating and maintenance instructions supplied and (by the installer) with the fitting manual and relevant standards and regulations in effect at the date of installation.





Symbols used in this manual:





	WARNING	Could cause serious injury or death
	CAUTION	Could cause minor or moderate injury or damage to property
	DO NOT	
	DO	





1.2 Safety instructions for users

 WARNING	
	The overflow from the safety valve shall NOT be sealed or plugged.
	The product shall NOT be modified or changed from its original state.
	Children shall NOT play with the product or go near it without supervision.
	Maintenance/settings shall only be carried out by persons over 18 years of age, with sufficient understanding

 CAUTION	
	The product shall not be exposed to frost, over-pressure or chlorine treatment. See warranty provisions.
	Maintenance/settings shall not be carried out by persons of diminished physical or mental capacity, unless they have been instructed in the correct use by someone responsible for their safety.

1.3 Safety instructions for installers

 WARNING	
	The overflow from the safety valve shall NOT be sealed or plugged. Safety valve is supplied with the product.
	The discharge pipe from any safety device shall be at least one pipe size larger than the nominal outlet size of the safety device (< 9m length). The discharge pipe shall have continuous fall to drain, be uninterrupted and frost-free at all times.
	The relevant regulations and standards, and this installation manual, shall be followed.

 CAUTION	
	The product shall be placed in a room with a floor drain. The manufacturer assumes no responsibility whatsoever if this provision is not followed.
	The product shall be properly aligned vertically and horizontally, on a floor suitable for the total weight of the product when in operation. See type plate.
	The product must have a clearance for servicing of 40 cm in front of the connections.

2. PRODUCT DESCRIPTION

2.1 Product identification

Identification details for your product can be found on the type plate fixed to the product. The type plate contains details of the product in accordance with EN 12897:2016 as well as other useful data. See Declaration of Conformity at www.osohotwater.com for more information.

OSO products are designed and manufactured in accordance with:

- Pressure vessel standard EN 12897:2016
- Welding standard EN ISO 3834-2

OSO Hotwater AS is certified for

- Quality ISO 9001
- Environment ISO 14001
- Work environment ISO 45001

2.2 Intended use

Maxi ACCU Geocoil is designed for use as a buffer with preheating of tap water - without peak electrical load.

2.3 CE marking



The CE mark shows that the product complies with the relevant Directives. See Declaration of Conformity at www.osohotwater.com for more information.

The product complies with Directives for:

- Low voltage LVD 2014/35/EU
- Electromagnetic compatibility EMC 2014/30/EU
- Pressurised equipment PED 2014/68/EU

The safety valve(s) used must be CE marked and conform to PED 2014/68/EU.

2.4 Technical data

NRF no.	Product code:	Capacity persons	Weight kg.	Diameter x height mm	Freight vol. m ³	Heating time hours Δt 65°C	Actual vol. l.
800 1973	MAGC 600 - HX 4.0 m ²	Beregnes	131	ø 800x2030	1,28	-	544
801 1164	MAGC 1000 - HX 4.0 m ²	Beregnes	223	ø1000x2100	2,29	-	870
Regulation: 2017/1369/EU - Regulation: EU 812/2013				Directive: 2009/125/EC - Regulation: EU 814/2013			
Heat loss tested acc. to standard: EN 12897: 2015							

3. INSTALLATION INSTRUCTIONS

3.1 Products covered by these instructions

800 1973 Maxi Accu Geocoil - MAGC 600

801 1164 Maxi Accu Geocoil - MAGC 1000

3.2 Included in delivery

Ref no.	Pcs.	Description
1	1	Buffer tank without electric backup
2	1	Stainless steel coil HX (built-in)
3	1	Installation manual (this document)
4	1	Safety valve, 9 bar (supplied)

3.3 Product dimensions

All dimensions in mm.

Product	A*	B (HW)	C (coil)	D (coil)	E (CW)	∅
MAGC 600	2030	1530	260			800
MAGC 1000	2100	1680	300			1000

Tolerance +/- 5 mm.

* Tolerance + 50/-0 mm.

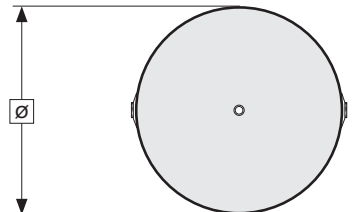
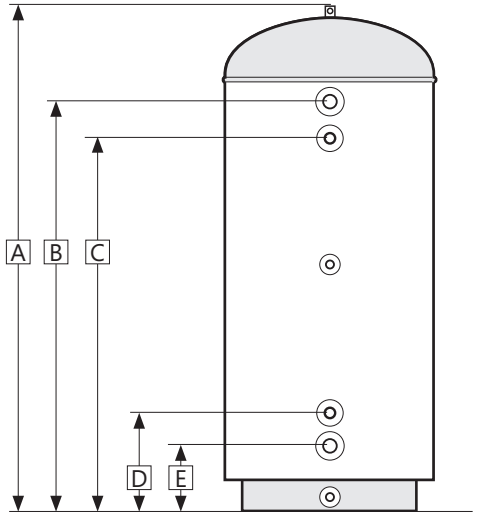
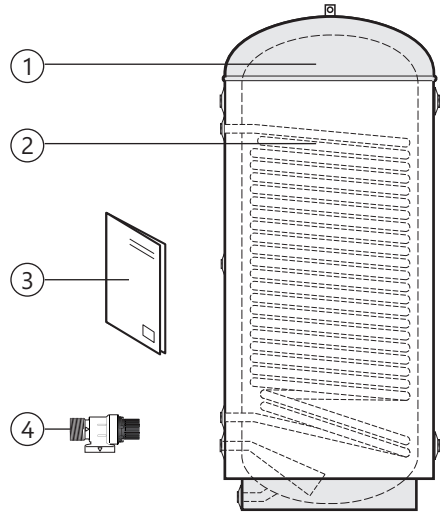

3.3.1 Delivery

The product should be transported carefully as shown, with packaging.

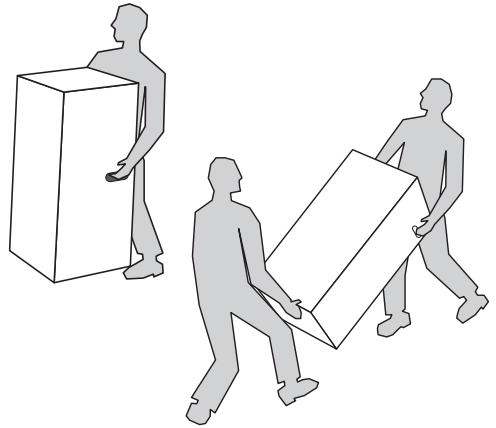

⚠ CAUTION
Pipe stubs, valves etc. should not be used to lift the product as this could cause malfunctions.

3.4 Requirements for installation location and positioning

⚠ CAUTION	
❗	The product shall be placed in a room with a floor drain. The manufacturer assumes no responsibility whatsoever if this provision is not followed.
❗	The product should be placed in a dry and permanently frost-free position.
❗	The product should be placed on a floor suitable for the total weight of the product when in operation.. See type plate.
❗	The product must have a clearance for servicing of 40 cm in front of the connections.
❗	The product should be easily accessible for servicing and maintenance.

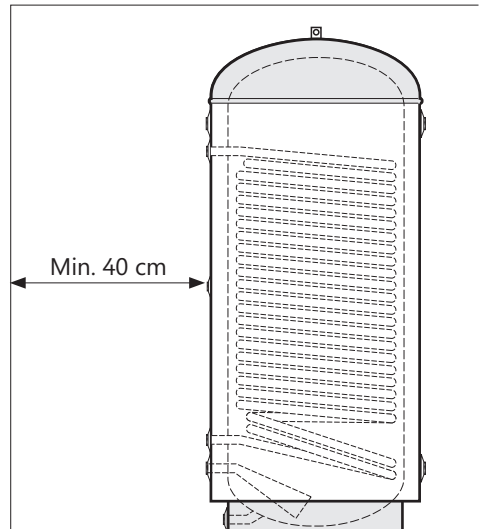
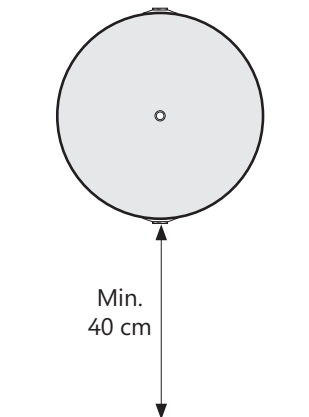

3.5 Pipe installation

The product is designed to be permanently connected to the mains water supply. Approved pipes of the correct size should be used for installation. The relevant standards and regulations must be followed.

No.	Dimension	Connection description
1	2" int. thread	2 x HW out
2	5/4" int. thread	Coil connection, upper
3	1/2" int. thread	Thermometer connection
4	5/4" int. thread	Coil connection, lower
5	2" int. thread	2 x CW in
6	1" ext. thread	Draining

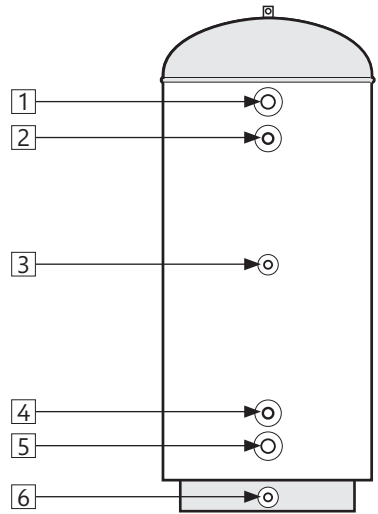

3.5.1 Incoming water pressure

The efficiency of the product depends on the incoming cold water pressure. The water pressure should be min. 2 bar and max. 6 bar throughout the day. Excessive water pressure can be adjusted by installing a pressure reduction valve.

3.5.2 Fitting pipes

- A) Run a pipe of suitable size to the connections shown, and affix with suitable sealant.
- B) Unused connections must be plugged securely.

3.5.3 Fitting of safety valve

A 9 bar safety valve with G 3/4" M connection is supplied with the product. The safety valve must be installed in a suitable place in the tap water circuit. The overflow of the safety valve must NOT be blocked or plugged.



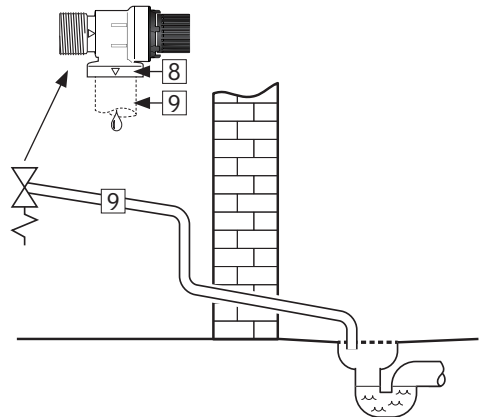

3.5.4 Fitting of overflow pipe

The discharge pipe from any safety device shall be at least one pipe size larger than the nominal outlet size of the safety device (< 9m length). The discharge pipe shall have continuous fall to drain, be uninterrupted and frost-free at all times;

- Connects to the overflow (8) on the safety valve (G 3/4" F).



3.5.4 Fitting instructions

 CAUTION	
	The product shall be placed in a room with a floor drain. The manufacturer assumes no responsibility whatsoever if this provision is not followed.
	The product should be properly aligned vertically and horizontally, on a floor suitable for the total weight of the product when in operation. See type plate.
	The product must have a clearance for servicing of 40 cm in front of the connections.

3.5.5 Fitting recommendation

RECOMMENDATION	
-	If the maximum water pressure exceeds 6 bar in a 24-hour period, a reduction valve and expansion vessel should be fitted.
-	For installation in a rooms which does not conform to the wetroom standard, a watertight drip tray with overflow pipe \geq 18 mm. inside diameter should be fitted under the product, in addition to an automatic stop cock with sensor. This will prevent possible material damage.

4. INITIAL COMMISSIONING

4.1 Filling with water

First check that all pipes are connected correctly. Then proceed as follows:

- A) Open a hot tap – leave it open
 - B) Open the cold water supply to the product.
- Check that the water from the open hot water tap is flowing freely, without any air locks. Close hot tap.

4.2 Control points

- A) Check that all pipe connections to/from the product are tight and not leaking.
- B) Check that the product is standing firmly vertically and horizontally.

4.3 Emptying of water

 WARNING
The water temperature in the product may exceed 75°C and could cause scalding. Before emptying, a hot tap should be opened to the max. pressure/temperature for min. 3 minutes.

- A) Shut off/disconnect from the heat source.
- B) Shut off incoming cold water supply.
- C) Open a hot tap to the maximum – leave open (prevents vacuum).
- D) Open the product's drain connection (1). Product emptied. After emptying, the drain connection should be plugged again before the product is refilled with water.

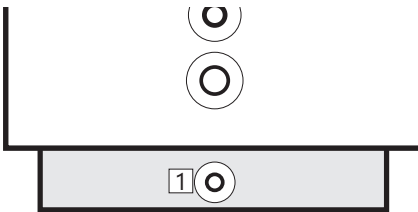

4.4 Handover to end-user

THE INSTALLER MUST:
Brief the end-user on safety and maintenance instructions.
Brief the end-user on settings and emptying the product.
Hand this installation manual over to the end-user.
Enter contact details on the type plate on the product.

5. USER GUIDE

5.1 Settings



The product should be supported and stable vertically and horizontally. When the product is placed correctly and is connected according to the guidelines for pipe fitting in section 3.5, there is no need for any additional settings.

5.2 Annual inspection

All components fitted in or to the product must be inspected annually. Inspection must be performed by person older than 18 years of age, with appropriate qualifications. Annual inspection includes:

- Checking all connections for leaks. Tighten or maintain properly if required..
- Inspection of safety valve operation, see pt. 5.3.

5.3 Maintenance

MAINTENANCE INSTRUCTIONS	
	Maintenance should be carried out by persons over 18 years of age, with sufficient understanding.
	Annual inspection of safety valve:
-	Open valve for 1 min. by turning the knob approx. 90 degrees to the open position.
-	Visually check that the water is flowing freely to the drain.
-	YES = OK. Close the valve by turning the knob further to the closed position.
-	NO = NOT OK. Disconnect power supply / shut off water supply. Contact installer.

6. TROUBLESHOOTING

6.1 Faults and fixes

If problems arise when the product is in use, check for possible faults and fixes in the table.

1. Water leaking from pipe connection.
Possible cause: Pipe connection is loose or sealant is insufficient.
Possible solution: Tighten pipe connection, replace sealant if necessary.
2. Water leaking from the tank, not the pipe connection.
Possible cause: Leakage from the steel tank.
Possible solution: Check if it is possible to see the leak point. Contact installer.

If you are unsure what is wrong, contact the installer (see product type plate) or OSO Hot-water AS - see section 7.1.

7. WARRANTY CONDITIONS

1. Scope

OSO Hotwater AS (hereinafter called OSO) warrants for 2 years from the date of purchase, that the Product will: i) conform to OSO specification, ii) be free from defects in materials and workmanship, subject to conditions below. All components carry a 2-year warranty.

The warranty is voluntarily extended by OSO to 5 years for the stainless steel inner tank. This extended warranty only applies to Products purchased by a consumer, that has been installed for private use and that has been distributed by OSO or by a distributor where the Products have been originally sold by OSO. The extended warranty does not apply to Products purchased by commercial entities or for Products that have been installed for commercial use. These shall be subject only to the mandatory provisions of the law. The conditions and limitations set out below shall apply.

2. Coverage

If a defect arises and a valid claim is received within the statutory warranty period, at its option and to the extent permitted by law, OSO shall either: i) repair the defect, or; ii) replace the product with a product that is identical or similar in function, or; iii) refund the purchase price.

If a defect arises and a valid claim is received after the statutory warranty period has expired, but within the extended warranty period, OSO will supply a product that is identical or similar in function. OSO will in such cases not cover any other associated costs.

Any exchanged Product or component will become the legal property of OSO. Any valid claim or service does not extend the original warranty. The replacement Product or part does not carry a new warranty.

3. Conditions

The Product is manufactured to suit most public water supplies. However, there are certain water chemistries (outlined below) that can have a detrimental effect on the Product and its life expectancy. If there are uncertainties regarding water quality, the local water supply authority can supply the necessary data.

The warranty applies only if the conditions set out below are met in full:

- The Product has been installed by a professional installer, in accordance with the instructions in the installation manual and all relevant Codes of Practice and Regulations in force at the time of installation.
- The Product has not been modified in any way, tampered with or subjected to misuse and no factory fitted parts have been removed for unauthorized repair or replacement.
- The Product has only been connected to a domestic mains water supply in compliance with the European Drinking Water Directive EN 98/83 EC, or latest version. The water

should not be aggressive, i.e. the water chemistry shall comply with the following:

- Chloride	< 250 mg / L
- Electric Conductivity (EC) @25°C	< 750 uS / cm
- Saturation Index (LSI) @80°C	> -1,0 / < 0,8
- pH level	> 6,0 / < 9,5

- The immersion heater has not been exposed to hardness levels exceeding 10°dH (180 ppm CaCO₃). A water softener is recommended in such cases.
- Any disinfection has been carried out without affecting the Product in any way whatsoever. The Product shall be isolated from any system chlorination.
- The Product has been in regular use from the date of installation. If the Product is not intended to be used for 60 days or more, it must be drained.
- Service and/or repair shall be done according to the installation manual and all relevant codes of practice. Any replacement parts used shall be original OSO spare parts.
- Any third-party costs associated with any claim has been authorized in advance by OSO in writing.
- The purchase invoice and/or installation invoice, a water sample as well as the defective product is made available to OSO upon request.

Failure to follow these instructions and conditions may result in product failure, and water escaping from the Product.

4. Limitations

The warranty does not cover:

- Any fault or costs arising from incorrect installation, incorrect application, lack of regular maintenance in accordance with the installation manual, neglect, accidental or malicious damage, misuse, any alteration, tampering or repair carried out by a non-professional, any fault arising from the tampering with or removal of any factory fitted safety components or measures.
- Any consequential damage or any indirect loss caused by any failure or malfunction of the Product whatsoever.
- Any pipework or any equipment connected to the Product.
- The effects of frost, lightning, voltage variation, lack of water, dry boiling, excess pressure or chlorination procedures.
- The effects of stagnant (de-aerated) water if the Product has been left unused for more than 60 days consecutively.
- Damage caused during transportation. Buyer shall give the carrier notice of such damage.
- Costs arising if the Product is not immediately accessible for servicing.

These warranties do not affect the Buyer's statutory rights.

7.1 Customer service

In case of problems that cannot be resolved with the aid of the troubleshooting guide in this installation manual, contact either:

- A) The installer who supplied the product.
- B) OSO Hotwater AS: Tel.: +47 32 25 00 00
oso@oso.no / www.oso.no

8. REMOVING THE PRODUCT

8.1 Removal

- A) Disconnect the power supply.
- B) Shut off incoming cold water supply.
- C) Empty the product of water – see section 4.4.
- D) Disconnect all pipes.
- E) The product can now be removed.

8.2 Returns scheme

This product is recyclable and should be taken to the environmental recycling centre. If the product is to be replaced with a new one, the installer can take the old cylinder away for recycling.

OSO

HOTWATER

OSO Hotwater AS

Industriveien 1
3300 Hokksund - Norway
Tel: + 47 32 25 00 00
oso@oso.no
www.osohotwater.com