

Productinformatieblad

Specificaties



flush mounted white illum selector switch head 2-position stay put

ZB4FK1213

Belangrijk bericht: A change in appearance may be noted on the product but does not affect its use in terms of function and safety. This makes it compatible with our Universal LED blocks
EAN Code: 3606489582029

Prijs: 27,65 EUR

Hoofd

range of product	Harmony XB4
product of component type	Kop voor verlichte keuzeschakelaar
compatibiliteit product	Universele LED
device short name	ZB4F
kraag materiaal	Verchroomd metaal
koptype	Built-in-flush
bevestigingsdiameter	30,5 mm
verkoop per ondeelbare hoeveelheid	1
vorm van kop signaleringseenheid	Rond
type operator	blijven
profiel operator	Wit standaard hendel
informatie positie operator	2 standen 90°

Complementair

CAD totale breedte	36,6 mm
CAD totale hoogte	36,6 mm
CAD totale diepte	35 mm
gewicht product	0,078 kg
weerstand hoge druk drukring	7000000 Pa om 55 °C, afstand: 0.1 m
mechanical durability	1000000 cycles
elektrische samenstellingscode	M3 voor <4 contacten gebruik enkelvoudig blokken in vooraan gemonteerd met integrale LED M6 voor <2 contacten gebruik enkelvoudig blokken in vooraan gemonteerd met ingebouwde LED en transformator M10 voor <2 contacten gebruik enkelvoudig blokken in vooraan gemonteerd met integrale LED M4 voor <4 contacten gebruik enkelvoudig en dubbel blokken in vooraan gemonteerd met integrale LED
product presentatie	Basisonderdeel

Omgeving

beschermende behandeling	TH
ambient air temperature for storage	-40...70 °C

De weergegeven prijs is de adviesprijs in euro excl. BTW. Deze kan onderhevig zijn aan korting. Neem contact op met uw lokale distributeur of detailhandel voor de daadwerkelijke prijs

omgevingstemperatuur voor werking	-40...70 °C
overvoltage category	Klasse I In overeenstemming met IEC 60536
IP beschermingsgraad	IP66 In overeenstemming met IEC 60529 IP67 In overeenstemming met IEC 60529 IP69 In overeenstemming met IEC 60529 IP69K In overeenstemming met ISO 20653 Type 13 In overeenstemming met UL 50 E Type 12 In overeenstemming met UL 50 E Type 4 In overeenstemming met UL 50 E Type 4X In overeenstemming met UL 50 E
IK-beschermingsgraad	IK04 In overeenstemming met IEC 50102
standards	CSA C22.2 Nr 14 IEC 60947-5-1 IEC 60947-5-4 UL 508 IEC 60947-1 JIS C8201-5-1 CE JIS C8201-1
product certifications	UL listed CSA CCC EAC
trilling bestendigheid	5 gn (f= 10...500 Hz) In overeenstemming met IEC 60068-2-6 2 mm piek-piek (f= 2...10 Hz) In overeenstemming met IEC 60068-2-6
schokbestendigheid	30 gn (duur = 18 ms) voor halve sinusgolf versnelling In overeenstemming met IEC 60068-2-27 50 gn (duur = 11 ms) voor halve sinusgolf versnelling In overeenstemming met IEC 60068-2-27 25 gn (duur = 6 ms) voor 1000 schokken op elke as In overeenstemming met IEC 60068-2-27

Verpakkingseenheid

Eenheidstype van verpakking 1	PCE
Aantal eenheden in verpakking 1	1
verpakking 1 hoogte	5,6 cm
verpakking 1 breedte	4,3 cm
verpakking 1 lengte	5,2 cm
verpakking_1_gewicht	69,0 g
Eenheidstype van verpakking 2	S02
Aantal eenheden in verpakking 2	80
verpakking 2 hoogte	15,0 cm
verpakking 2 breedte	30,0 cm
verpakking 2 lengte	40,0 cm
verpakking 2 gewicht	5,818 kg

contractuele waarborg

Garantie (in maanden)	18
------------------------------	----

Schneider Electric wil tegen 2050 de Net Zero-status hebben bereikt via partnerschappen in de toeleveringsketen, materialen met een lagere impact en circulariteit via onze doorlopende campagne "Use Better, Use Longer, Use Again" om de levensduur van producten en de recycleerbaarheid te verlengen.

[Uitleg van Environmental Data >](#)

[Hoe evalueren we de duurzaamheid van producten? >](#)

Milieuoetafdruk

Totale levenscyclus ecologische voetafdruk	0.6 kg CO2 eq.
Koolstofvoetafdruk van de fabricagefase [A1–A3]	0.5 kg CO2 eq.
Koolstofvoetafdruk van de distributiefase [A4]	0 kg CO2 eq.
Koolstofvoetafdruk van de installatiefase [A5]	0 kg CO2 eq.
Koolstofvoetafdruk van de gebruiksfase [B2, B3, B4, B6]	0 kg CO2 eq.
Koolstofvoetafdruk van de einde-levensfase [C1–C4]	0.1 kg CO2 eq.
Milieu Profiel	Milieuprofiel van het product

Use Better

Materialen en verpakking

Pakket met gerecycleerd karton	Ja
Verpakkingen zonder kunststof	Ja
RoHS-richtlijn van de EU	Conform
REACH-verordening	Referentie bevat geen SVHC boven drempelwaarde

Use Longer

Levensduurverlenging

Reparatie	Nee
-----------	-----

Use Again

Herverpakken en herfabriceren

Circulair Profiel	Informatie over einde levensduur
Terugname	Ja

Dimensions Drawings

Dimensions

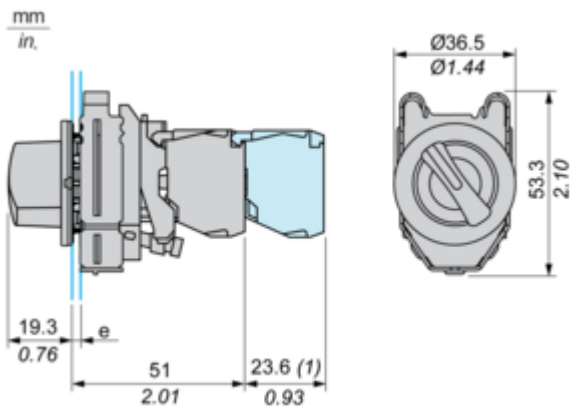

e : clamping thickness: 1 to 6 mm / 0.04 to 0.24 in.

(1) : Additional row of contacts

Mounting and Clearance

Panel Cut-out for Pushbuttons, Switches and Pilot Lights (Finished Holes, Ready for Installation)

Connection by Screw Clamp Terminals or Plug-in Connectors

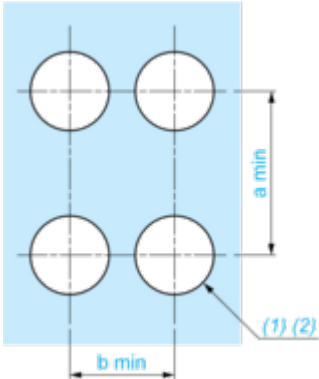

(1) : Diameter on finished panel or support

(2) : $\text{Ø}30.75 \text{ mm recommended } (\text{Ø}30.5 \text{ }_0^{+0.5}) / \text{Ø}1.21 \text{ in. recommended } (\text{Ø}1.20 \text{ in. }_0^{+0.0196})$

Connections	a in mm	a in in.	b in mm	b in in.
By connectors	50	1.97	40	1.57
By connectors and with legend holder ZBZF32	50	1.97	40	1.57
By connectors and with legend holder ZBZF33	60	2.36	40	1.57

Technical Description

Electrical Composition Corresponding to Code M3

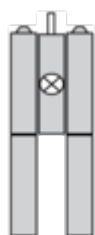

Electrical Composition Corresponding to Code M4



Electrical Composition Corresponding to Codes M6 and P2



Electrical Composition Corresponding to Codes M5, M10, MF1, MR1 and MF2

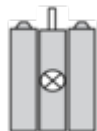

Legend

Single contact



Double contact



Light block



Possible location



Sequence of Contacts Fitted to 2-position Selector Switch Body

Position 315°



Push	Position	Top			
		Bottom			
	Location		Left		Right
	State		0		0
	Contacts		N/O		open
		N/C	closed	closed	

Position 45°



Push	Position	Top			
		Bottom			
	Location		Left		Right
	State		1		1
Contacts		N/O	closed	closed	
		N/C	open	open	

Technical Illustration

Dimensions

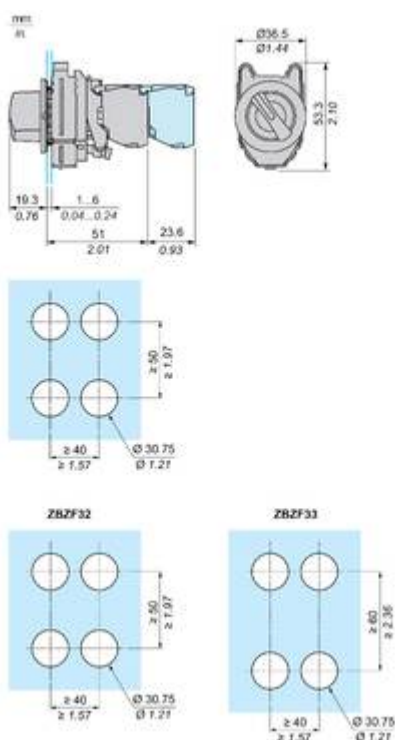

Offer Marketing Illustration

Product benefits / Features

The infographic features a central image of three electrical components: a red pushbutton, a green illuminated pushbutton, and a black selector switch. Surrounding this central image are five circular icons, each with a white background and a green symbol. The icons represent: 1) A stylized 'S' for design, 2) A lightning bolt and cloud for harsh environments, 3) A hand pointing to a hole for installation, 4) A hand cleaning a surface for ease of cleaning, and 5) A wrench and screwdriver for installation.

Features

Harmony XB4/XB5
Flush mounting solution

- Innovative and attractive design improving the look and feel of control panels and machines
- Robustness to withstand harsh environments
- Available for pushbuttons, illuminated pushbuttons, pilot lights and selector switches
- Quick and easy installation into a standard 30mm hole
- Easier to clean with towels than standard offers

Offer Marketing Illustration

Product benefits / Features

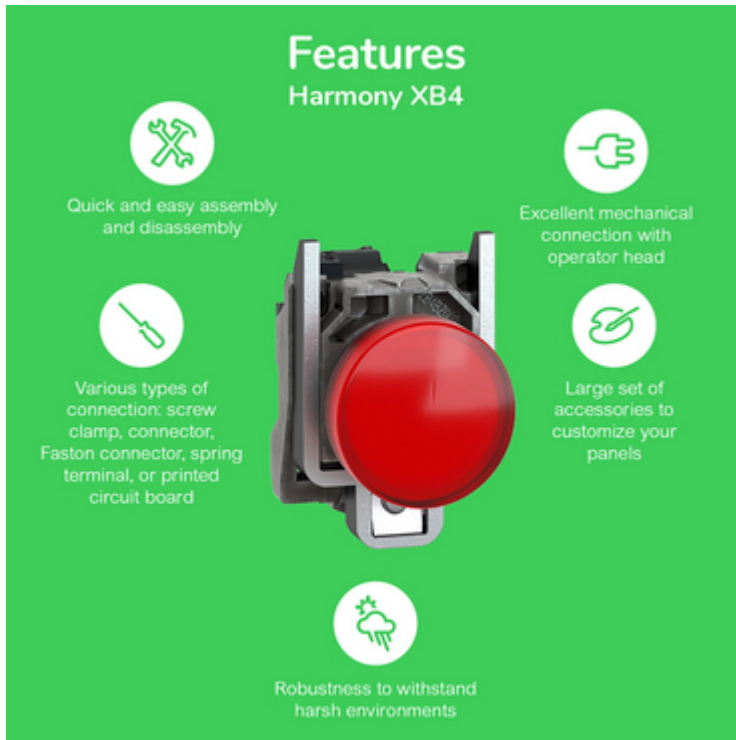

The infographic features a central image of a red Schneider XB4 terminal block. Surrounding it are five circular icons, each with a corresponding text description of a feature. The background is a solid green color.

Features Harmony XB4

- Quick and easy assembly and disassembly** (Icon: crossed wrench and screwdriver)
- Excellent mechanical connection with operator head** (Icon: hand holding a plug)
- Large set of accessories to customize your panels** (Icon: plug with a slash through it)
- Robustness to withstand harsh environments** (Icon: lightning bolt and rain cloud)
- Various types of connection: screw clamp, connector, Faston connector, spring terminal, or printed circuit board** (Icon: screwdriver)

Offer Marketing Illustration

Product benefits / Features

Technical Benefits

Harmony XB4

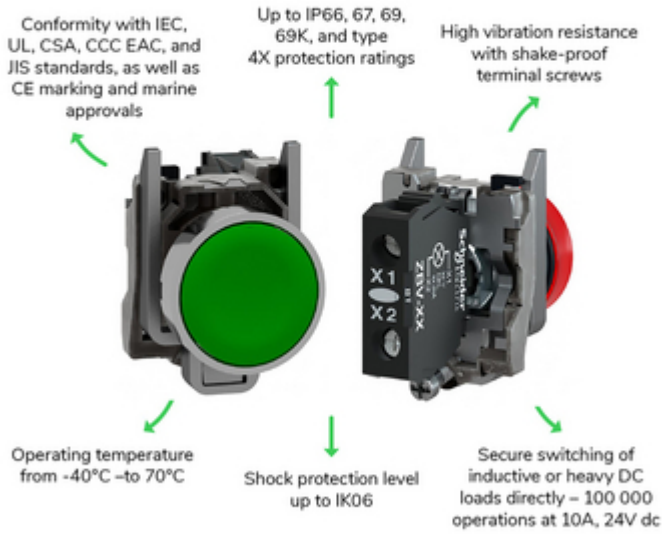

Image of product / Alternate images

Alternative

