

SpaceLogic Sensors

SLA Series Air Quality Sensors – Analog



Note: A subset of models shown.

Product Description

The SpaceLogic SLA Series of air quality sensors for living space is a flexible multisensor platform for use with BAS controllers designed to accept 4 to 20mA, 0 to 5Vdc or 0 to 10Vdc outputs. Housings are available in Medium matte white and Optimum faces available in black and white. All housing types are available with three user interface options: touchscreen, LCD with three buttons and blank. CO₂ and temperature sensors are included with all SLA Series air quality sensors. Models with VOC sensors and relative humidity sensors are also available.

Features

- Medium matte white housing or optimum glass panel housing available in white or black
- Field calibratable non-dispersive infrared CO₂ sensor
- Replaceable RH element available in 1% & 2% with NIST certificate
- VOC sensor available
- Temperature output on all models
- 61 mm (2.4") backlit color touchscreen and LCD, three button display options available
 - Digital temperature indication (0.1° display resolution of °F or °C)
 - Digital humidity indication (0.1% RH display resolution)
 - Digital CO₂ indication (0 to 2000 ppm display resolution)
 - Stoplight feature for visual indication at user-configurable CO₂ threshold levels (touchscreen models only)
 - Selectable temp, RH and fan speed setpoint (0-10V)
 - Configurable screen/button lock and display timeout
 - Override
- Selectable 4 to 20mA, 0 to 5V and 0 to 10V analog outputs
- 18-24 AWG screw terminals

Available Products Matrix

SLA	<input type="checkbox"/> Housing	<input type="checkbox"/> User Interface	<input type="checkbox"/> CO ₂ Sensor	<input type="checkbox"/> RH Sensor*	Example: SLA S T C 2
	S = Medium white matte housing	T = Color touchscreen	C = NDIR CO ₂	2 = 2%	
	W = Optimum white housing	L = 3-button LCD display	CV = NDIR CO ₂ / VOC	X = None	
	B = Optimum black housing	X = None			

*Replaceable RH module available to be ordered separately per table below.

Replaceable RH Elements

Model	RH Accuracy	Calibration Certificate	Description
SLXRHS1N	±1%	X	Replaceable RH Sensor, 1% w/NIST Cert
SLXRHS2N	±2%	X	Replaceable RH Sensor, 2% w/NIST Cert
SLXRHS2X	±2%		Replaceable RH Sensor, 2%

USA: +1 888-444-1311
 Europe: +46 10 478 2000
 Asia: +65 6484 7877
www.schneider-electric.com

Life Is On



Operating Environment			
Input power	Class 2; 20 to 30 Vdc, 24 Vac, 50 to 60 Hz		
Analog output	Selectable 4 to 20 mA, 0 to 5 V, 0 to 10 V		
Operating temp. range	0 to 50 °C (32 to 122 °F)		
Operating humidity range	0 to 95% RH non-condensing		
Housing material	High impact ABS plastic		
IP rating	IP 30		
Mounting location	For indoor use only. Not suitable for wet locations.		
Surface mount	The device can be surface mounted on Single Gang J-Box, British Standard and CE60 wall boxes		
CO₂ Sensor			
Sensor type	Non-dispersive infrared (NDIR), diffusion sampling		
Output range	0 to 2000/5000 ppm (selectable)		
Accuracy	±30 ppm ±3% of measured value		
Repeatability	±20 ppm ±1% of measured value		
Response time	<60 seconds for 90% step change		
VOC Sensor			
Sensor type	Solid state		
Output range	0 to 100% AQI for VOC		
Accuracy	±15% of measured value		
Output scale	0 to 1,000 ppb of total VOC (TVOC)		
AQI table*	Level	Ventilation Recommendation	TVOC (ppb)
	>61%	Greatly increased	>610
	20 to 61%	Significantly increased	200 to 610
	10 to 20%	Slightly increased	100 to 200
	5 to 10%	Average	50 to 100
	0 to 5%	Target value	0 to 50
RH Sensor			
HS sensor	Solid state capacitive, replaceable		
Accuracy**	±2% from 10 to 80% RH @ 25°C (77 °F)		
Hysteresis	1.5% typical		
Linearity	Included in accuracy specification		
Stability	±1% @ 20°C (68 °F) annually for 2 years		
Output range	0 to 100% RH		
Temperature coefficient	±0.1% RH/°C above or below 25 °C (77 °F) typical		
Temperature Sensor			
Sensor type	Solid state, integrated circuit		
Accuracy	±0.2 °C (±0.4 °F) typical		
Resolution	0.1 °C (0.1 °F)		
Range	0 to 50 °C (32 to 122 °F)		

Display Models	
Touchscreen	61 mm (2.4 in), color, backlit, capacitive, 240x300px Setpoint: 0-10Vdc. Temperature, humidity or fan speed selectable Timeout override: Display timeout*** Lockout override: Touchscreen/button lockout***
LCD	52mm (2.05 in), segmented with 3 buttons Setpoint: 0-10Vdc. Temperature, humidity or fan speed selectable Timeout override: Display timeout*** Lockout override: Touchscreen/button lockout***
Setpoints****	
Temperature setpoint	0 to 10V output Scale: 10 to 35 °C (50 to 95 °F) / 0 to 50 °C (32 to 122 °F)
Humidity setpoint	0 to 10V output Scale: 0 to 100% RH
Fan speed setpoint	0 to 10V output Off 0V, Auto 1.5V, Low 3.3V, Med. 6.7V, High 10.0V
Override	
Override button	Display models feature momentary-to-ground override button
Wiring Terminals	
Terminal blocks	Screw terminals, 18-24 AWG
Screw terminal torque	0.2 N-m (2.0 in-lbF) max.
Regulatory Information	
	UL 916, European conformance CE: EN61000-6-2 EN61000-6-3 EN61000 Series - industrial immunity EN 61326-1
Agency approvals	FCC Part 15 Class B, REACH, RoHS, Green Premium, RCM (Australia), ICES-003 (Canada), EAC (Russia), UKCA (UK)

* Air Quality Index for VOC aligns with TVOC levels for IAQ as specified by the WHO (World Health Organization).
 ** Humidity sensor measurement uncertainty should include: accuracy, hysteresis, temperature coefficient and stability.
 *** DIP switch selectable.
 **** One setpoint type is selectable via DIP switch on display models only.

Dimensions mm (in.)
Optimum Housing

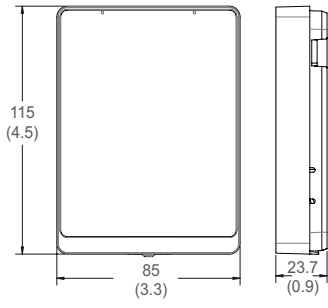

Medium Housing

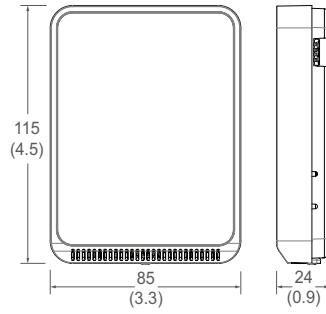

Base Hole Measurement

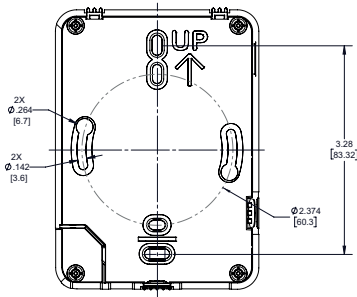

Installation

1. Remove the cover from the base at the bottom of the device.



2. Position the sensor base vertically on the wall 1.35 m (4.5 ft.) above the floor with the “UP” arrow facing upward. Locate away from windows, vents and other sources of draft. If possible, do not mount on an external wall, as this may cause inaccurate temperature readings.

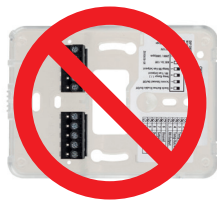
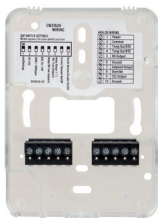

3. Pull 18 or 22 AWG cable(s) through the hole in the backplate.



4. Mount the backplate onto the wall using the screws provided.

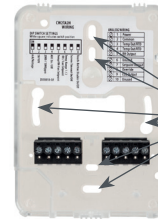

Six screw holes available. Use a minimum of two for secure mounting.

5. Connect the wires to the screw terminals. Do not over-tighten the screws.



Wiring diagram:

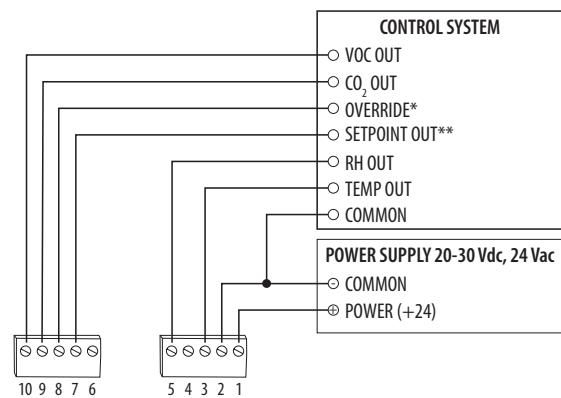

* Momentary to ground.

** 0-10V DIP switch selectable for temperature, RH (if equipped) or fan speed (off, 0V, Auto 1.5V, Low 3.3V, Medium 6.7V or high 10V).

USA: +1 888-444-1311
Europe: +46 10 478 2000
Asia: +65 6484 7877
www.schneider-electric.com

Life Is On

Schneider Electric

Installation (cont.)

6. Set the DIP switches.

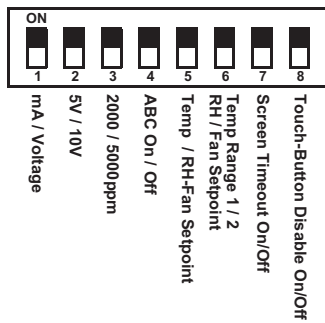

Switch	Function	Description
1	Output mode	ON - 4-20mA output mode enabled OFF - Voltage output mode enabled
2	Voltage output range*	ON - 0-5V output range enabled OFF 0-10V output range enabled
3	CO ₂ output range	ON - 0-2000 ppm CO ₂ output range enabled OFF - 0-5000 ppm CO ₂ output range enabled
4	Automatic Baseline Calibration (ABC) for CO ₂	ON - ABC enabled OFF - ABC disabled
5	Setpoint output type	ON - Temperature setpoint enabled (temp range selected on DIP switch 6) OFF - RH or Fan Speed setpoint enabled (specific setpoint output type to be selected on DIP switch 6) Models without RH option select only temp or fan setpoint
6	Setpoint output temperature range or RH/Fan Speed output type	Temperature setpoint (must be enabled on DIP switch 5) ON - Temp range 1, 50 to 95 °F (10 to 35 °C) enabled OFF - Temp range 2, 32 to 122 °F (0 to 50 °C) enabled RH or Fan Speed setpoint (must be enabled on DIP switch 5) ON - RH setpoint enabled OFF - Fan Speed setpoint enabled Models without RH option, set to OFF
7	Display times out and turns off after 6-10 seconds of touchscreen/button press	ON - Display Timeout enabled OFF - Display Timeout disabled

Switch	Function	Description
8	Touchscreen touch functions and buttons are disabled	ON - Touchscreen touch/button functions disabled OFF - Touchscreen touch/button functions enabled

* Only used with voltage output mode enabled. Not applicable to setpoint output. Setpoint is 0-10V fixed.

7. With sensor base fully installed, align top of cover to mounting tabs on top of sensor base. Swing cover downward until it latches at the bottom.



8. Install locking screw to secure cover in closed position.



CO₂ Sensor Calibration

There are two methods for CO₂ calibration available: 400 ppm baseline calibration and automatic baseline calibration (ABC).

400 ppm Baseline Calibration

400 ppm baseline calibration allows the sensor to be set at 400 ppm. Push and hold the calibration button for 3 to 5 seconds. The LED will flash green. Once the button is released, calibration is complete and the LED switches off.

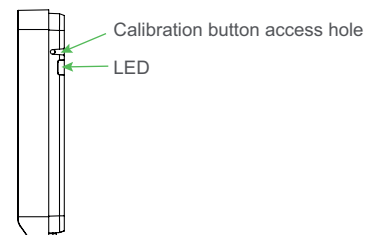

Automatic Baseline Calibration (ABC)

The ABC mode addresses the 400 ppm calibration. It allows turning on or off a background correction/recovery mode that will minimize any calibration error that has been caused by shock during handling and transportation or is caused by a long term shift in measurement. The ABC algorithm constantly keeps

track of the sensor’s lowest reading over a preconfigured time interval and slowly corrects for any long-term drift detected as compared to the expected fresh air value of 400 ppm. After initial startup, it is expected that the sensor reaches specified accuracy after 7 to 21 days.

Touchscreen Operation

Main Screen

The touchscreen user interface displays applicable sensor output values (temperature, RH, CO₂ and VOC), setpoint value, menu button and CO₂ stoplight status (if enabled).

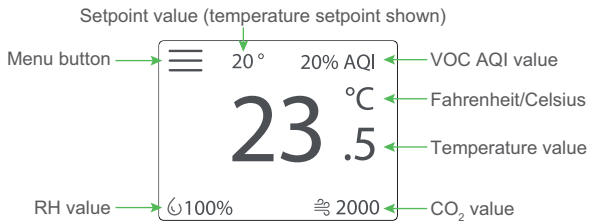

Menu Screen

The menu screen opens when pressing the Menu button on the main screen. Integrator’s submenu, occupancy/override, Fahrenheit/Celsius, settings, setpoint submenu (temp, RH or fan, determined by DIP switch settings) and CO₂ stoplight buttons are displayed on the menu screen.

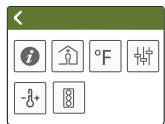

Temperature setpoint
DIP switch selected

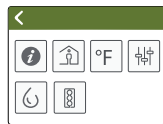

RH setpoint
DIP switch selected

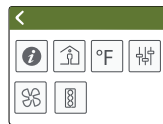

Fan Speed setpoint
DIP switch selected

Menu Button Functions

Integrator’s Submenu
Press this icon to access the Integrator’s menu.

Submenu Only

Model	SLASTC2
Serial #	4E54F3B5
Date code	2020
Rev code	01A

Occupied Override Button
Press this icon to provide momentary ground output to the controller

Single Press Only
Signals occupied/override call to controller.

Fahrenheit/Celsius Switch
Press this icon to display either °C or °F.

Single Press Only
 °F Changes units to Fahrenheit when pressed.
 °C Changes units to Celsius when pressed.

USA: +1 888-444-1311
 Europe: +46 10 478 2000
 Asia: +65 6484 7877
www.schneider-electric.com

Life Is On



Menu Button Functions (cont.)

Settings
This icon provides the ability to change the color scheme of the display.

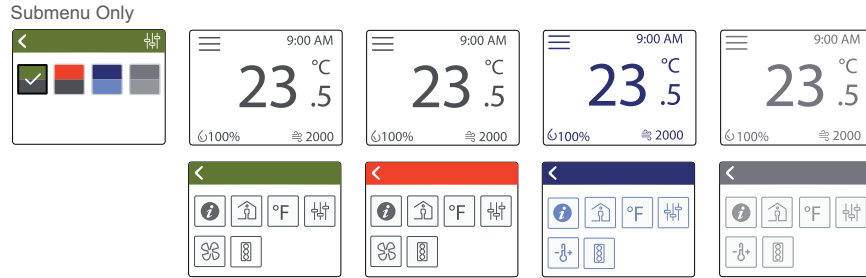

Temp Setpoint Adjustment
Click this icon to access the setpoint change menu. Mutually exclusive with fan speed, set by DIP switch.

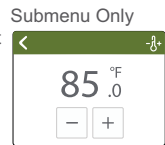

Humidity Setpoint Adjustment
Click this icon to access the setpoint change menu. Mutually exclusive with humidity and fan speed. Set by DIP switch.

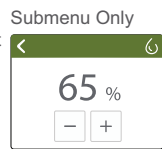

Fan Speed
Click this icon to access the fan speed menu.

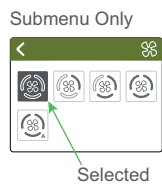

CO₂ Stoplight Menu
Click this icon to toggle the CO₂ Stoplight feature on and off. With CO₂ Stoplight turned on, the background color of the main screen changes with CO₂ level. This provides a visual indicator of CO₂ levels to the room occupants.

Using the +/- buttons, the thresholds at which the colors change on the main screen are user configurable, as described in the diagram.

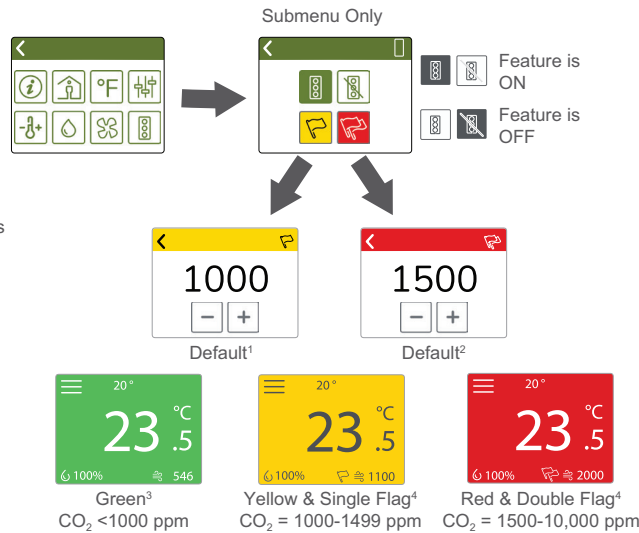

1. Values <400 ppm will be rounded up to the minimum limit of 400 ppm.
2. Values >10,000 ppm will be rounded down to the maximum limit of 10,000 ppm.
3. Possible to adjust CO₂ thresholds by changing the yellow and red limits.
4. User configurable in increments of 10 ppm using the +/- buttons. With a long press of these buttons, the number will change more quickly.

LCD Display Operation

Button Functions

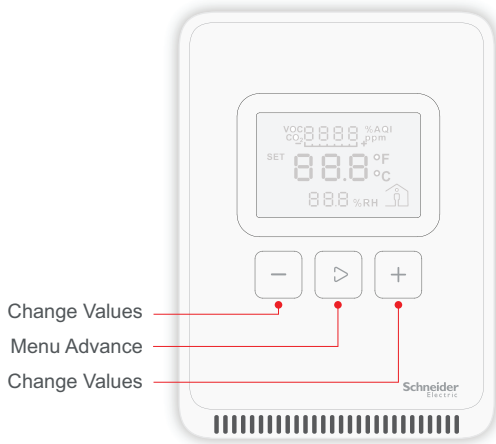

Display Icons

The main screen displays sensor values for CO₂, VOC (if equipped), RH (if equipped), temperature and Celsius/Fahrenheit.

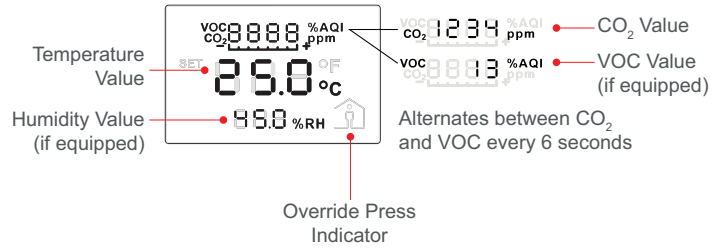

Setpoint Function

A single 0-10V setpoint (temperature, RH (if equipped) or fan speed) can be selected via DIP switch.

Temperature Setpoint Adjustment

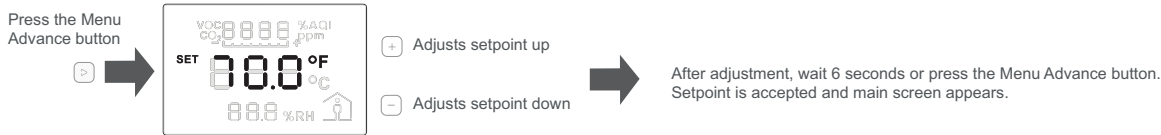

Note: Numeric information will flash while in Set mode.

RH Setpoint Adjustment



Note: Numeric information will flash while in Set mode.

Fan Speed Setpoint Adjustment

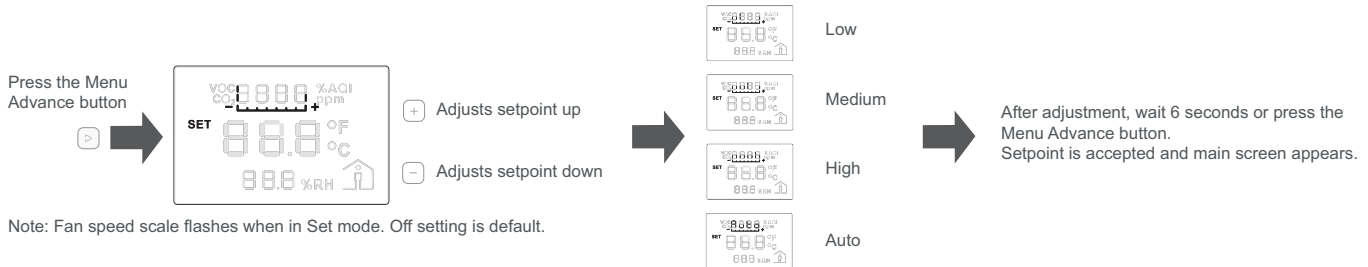

Note: Fan speed scale flashes when in Set mode. Off setting is default.

USA: +1 888-444-1311
 Europe: +46 10 478 2000
 Asia: +65 6484 7877
www.schneider-electric.com

Life Is On



Setpoint Function (cont.)

Changing Celsius and Fahrenheit Scales

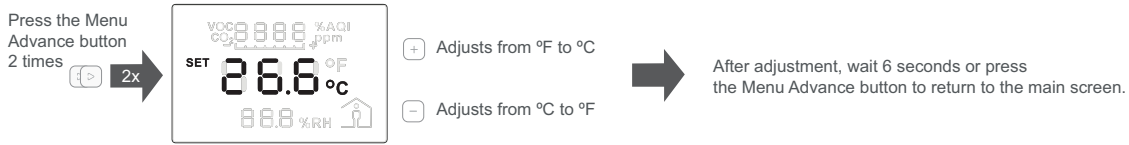

Note: °F or °C text will flash while in Set mode.

Occupied/Override Button

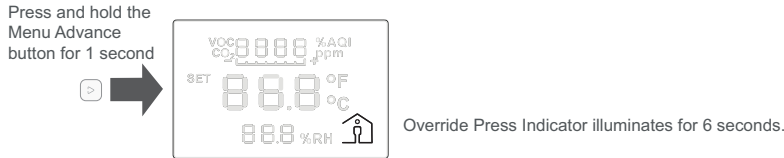

China RoHS Compliance Information Environment-Friendly Use Period (EFUP) Table

部件名称	有害物质 - Hazardous Substances					
Part Name	铅 (Pb)	汞 (Hg)	镉 (Cd)	六价铬 (Cr (VI))	多溴联苯 (PBB)	多溴二苯醚 (PBDE)
电子件 Electronic	X	O	O	O	O	O

本表格依据SJ/T11364的规定编制。

O: 表示该有害物质在该部件所有均质材料中的含量均在 GB/T 26572 规定的限量要求以下。
 X: 表示该有害物质至少在该部件的某一均质材料中的含量超出 GB/T 26572 规定的限量要求。
 (企业可在此处, 根据实际情况对上表中打 * 的技术原因进行进一步说明。)

This table is made according to SJ/T 11364.

O: indicates that the concentration of hazardous substance in all of the homogeneous materials for this part is below the limit as stipulated in GB/T 26572.

X: indicates that concentration of hazardous substance in at least one of the homogeneous materials used for this part is above the limit as stipulated in GB/T 26572

Z000057-0B

Schneider Electric Limited
 Stafford Park 5
 Telford TF3 3BL
 United Kingdom



USA: +1 888-444-1311
 Europe: +46 10 478 2000
 Asia: +65 6484 7877
 www.schneider-electric.com

Life Is On

