

# TRONIX

## 12W 1CH Zigbee NFC Enabled LED Driver(Constant Current)

Art.nr. 214-260



**Important:** Read All Instructions Prior to Installation

### Function introduction



### Product Data

Output	LED Channel	1
	DC Voltage	6-42V
	Current	100-700mA via NFC setting; Min.current gear lower to 0.1mA,Default 300mA
	Current Accuracy	±3% (±1% @ Certain full load) @ full load
	Rated Power	Max. 12W
Input	Voltage Range	200-240VAC/200-240VDC
	Absolute Voltage Range	176-264VAC/176-280VDC
	Frequency Range	0/50/60Hz
	Power Factor (Typ.)	> 0.97 @ 230VAC Full load
	Total Harmonic Distortion	THD ≤ 10% (@ full load / 230VAC)
	Efficiency (Typ.)	> 80% @ 230VAC full load
	AC Current (Typ.)	0.1A @ 230VAC
	Inrush Current (Typ.)	Max. 3.96A at 230VAC; 80µs duration
	Leakage Current	< 5mA/230VAC
	Standby Power Consumption	< 0.5W
Control	Anti Surge	L-N:2KV
	Dimming Interface	Zigbee
	Dimming Range	0.01%-100% @ Max current
	Dimming Method	Amplitude/CCR dimming
	Dimming Curve	Linear/ Logarithmic optional

Protection	Short Circuit	Yes, remove the fault conditions and re-power the device
	Over Current	Yes, remove the fault conditions and re-power the device
	Over Temperature	Yes, remove the fault conditions and re-power the device
Environment	Working Temp.	-25°C ~ +45°C
	Max. Case Temp.	TC=85°C (Ta= "45°C")
	Working Humidity	10% ~ 95% RH non-condensing
	Storage Temp. & Humidity	-40°C ~ +80°C, 10% ~ 95% RH
Safety & EMC	Safety Standards	EN61347-1, EN61347-2-13
	Withstand Voltage	I/P-O/P: 3.75KVAC
	Isolation Resistance	I/P-O/P: 100M Ohms / 500VDC / 25°C / 70% RH
	EMC Emission	En55015, EN61000-3-2, EN61000-3-3
	EMC Immunity	En61547, EN61000-4-2,3,4,5,6,8,11
Others	MTBF	191350H, MIL-HDBK-217F @ 230VAC full load and 25°C ambient temperature
	Dimension	135x35x20mm (L*W*H)
	Warranty	5 Years

- Dimmable LED driver, ZigBee device based on ZigBee 3.0 protocol
- Dimmable LED driver. Max. output power 12W
- 100-700mA current selectable via NFC program tool. Min.current gear lower to 0.1mA
- Dimming curve/Power on state/Soft start/Soft off via NFC program tool.
- Class II power supply, full isolated plastic case
- High power factor and efficiency
- To switch and dim LED lighting luminaries
- Amplitude/CCR dimming, smooth and deep dimming
- ZigBee end device that supports Touchlink commissioning
- Can directly pair to a compatible ZigBee remote via Touchlink
- Supports find and bind mode to bind a ZigBee remote
- Supports zigbee green power and can bind max. 20 zigbee green power switches
- Compatible with universal ZigBee gateway products
- Waterproof grade: IP20, suitable for indoor LED lighting applications
- 5 years warranty

### Safety & Warnings

- DO NOT install with power applied to the device.
- DO NOT expose the device to moisture.

## Operation--Zigbee Network

1. Do wiring according to connection diagram correctly.

2. This ZigBee device is a wireless receiver that communicates with a variety of ZigBee compatible systems. This receiver receives and is controlled by wireless radio signals from the compatible ZigBee system.

### 3. Zigbee Network Pairing through Coordinator or Hub (Added to a Zigbee Network)

**Step 1:** Remove the device from previous zigbee network if it has already been added to, otherwise pairing will fail.

**Step 2:** From your ZigBee Controller or hub interface, choose to add lighting device and enter Pairing mode as instructed by the controller.

**Step 3:** power on the device, it will be set into network pairing mode (connected light flashes twice slowly), the network pairing mode will last until the device is added to a zigbee network.

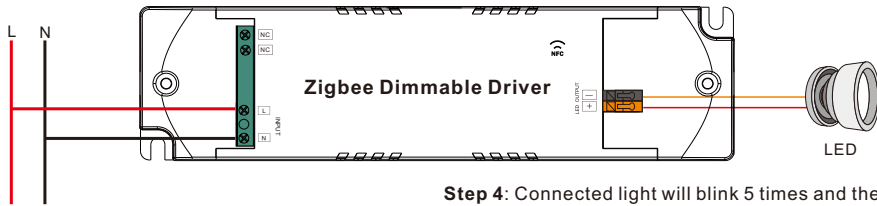

**Step 4:** Connected light will blink 5 times and then stay solid on, then the device will appear in your controller's menu and can be controlled through controller or hub interface.

### 4. TouchLink to a Zigbee Remote

**Step 1: Method 1:** re-power on the device 4 times to start Touchlink commissioning immediately, 180S timeout, repeat the operation.

**Method 2:** If the device is already added to a network, it will be set into Touchlink commissioning immediately, 180S timeout, re-power on the device to set it into touchlink commissioning again.

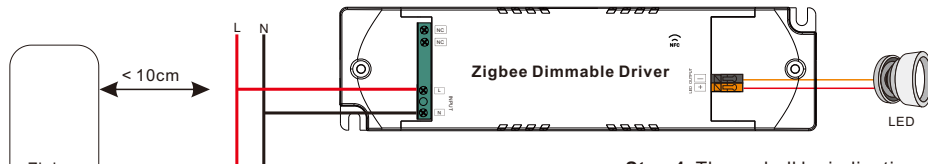

**Step 4:** There shall be indication on the remote for successful link and connected light will flash twice.

**Step 2:** Bring the remote or touch panel within 10cm of the lighting device.

**Step 3:** Set the remote or touch panel into Touchlink commissioning, please refer to corresponding remote or touch panel manual to learn how.

**Note:** 1) Directly TouchLink (both not added to a ZigBee network), each device can link with 1 remote.  
 2) TouchLink after both added to a ZigBee network, each device can link with max. 30 remotes.  
 3) To control by both gateway and remote, add remote and device to network first then TouchLink.  
 4) After TouchLink, the device can be controlled by the linked remotes.

### 5. Removed from a Zigbee Network through Coordinator or Hub Interface

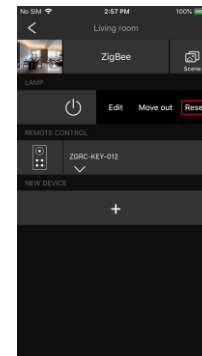

From your ZigBee controller or hub interface, choose to delete or reset the lighting device as instructed. The connected light blinks 3 times to indicate successful reset.

### 6. Factory Reset Manually

**Step 1:** Enable Pairing via NFC App or re-power on the device for 5 times continuously .

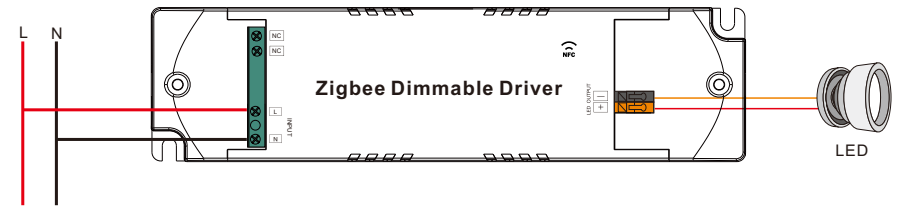

**Step 2:** Connected light will blink 3 times to indicate successful reset.

**Note:** 1) If the device is already at factory default setting, there is no indication when factory reset again .  
 2) All configuration parameters will be reset after the device is reset or removed from the network.

### 7. Find and Bind Mode

**Step 1:** Re-power on the device (initiator node) 3 times to start Find and Bind mode (connected light flashes slowly) to find and bind target node, 180 seconds timeout, repeat the operation.

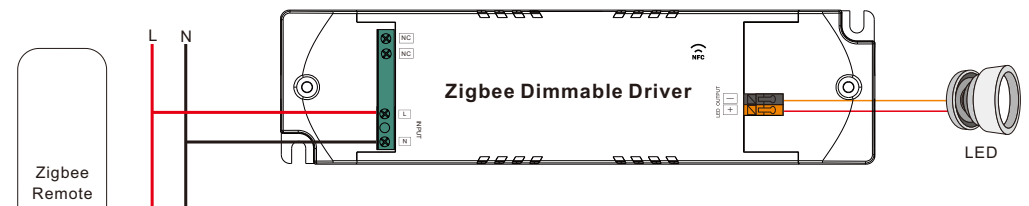

**Step 2:** Set the remote or touch panel (target node) into find and bind mode, and enable it to find and bind initiator, please refer to corresponding remote or touch panel manual.

**Step 3:** There shall be indication on the remote or touch panel that it bind the device successfully and can control it then.

## 8. Learning to a Zigbee Green Power Switch

**Step 1:** Re-power on the device 4 times to start Learning to GP switch mode (connected light flashes twice), 180 seconds timeout, repeat the operation.

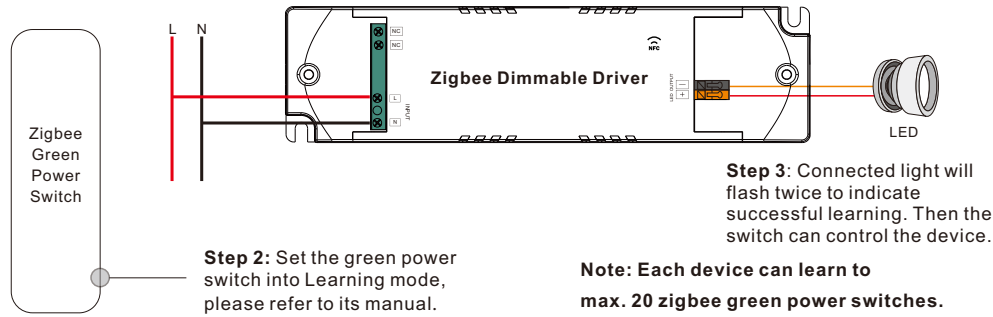

## 9. Delete Learning to a Zigbee Green Power Switch

**Step 1:** Re-power on the device 3 times to start delete Learning to GP switch mode (connected light flashes slowly), 180 seconds timeout, repeat the operation.

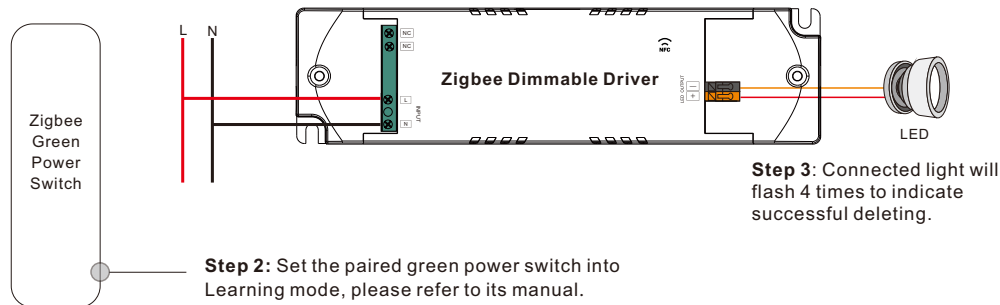

## 10. ZigBee Clusters the device supports are as follows:

### Input Clusters

- 0x0000: Basic
- 0x0003: Identify
- 0x0004: Groups
- 0x0005: Scenes
- 0x0006: On/off
- 0x0008: Level Control
- 0x0300: Color Control
- 0x0b05: Diagnostics

### Output Clusters

- 0x0019: OTA

## 11. OTA

The device supports firmware updating through OTA, and will acquire new firmware from zigbee controller or hub every 10 minutes automatically.

## Function setting Via "SR NFC TOOL"

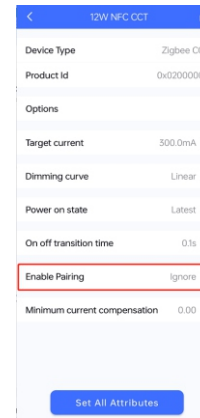

Enter Zigbee Functions.

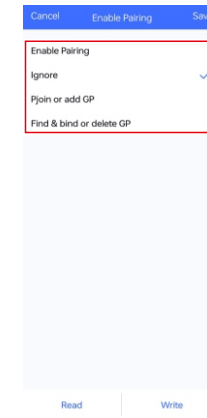

4 Different settings.

### 1) Enable Pairing

- Enable the Zigbee NFC drivers enter the pairing mode and add it into the Zigbee network.
- Factory reset. Enable the configured Zigbee NFC driver into configuring mode.
- Besides, you can re-power the device 5 times to enable this section as well.

### 2) Ignore

- Remember, once you need to write other parameters into the NFC driver, you should select this section, so as not to change the driver's state.

### 3) Pjoin or add GP

- This section as known as "Enable Touchlink & GP mode".
- Select this section and write it into the Zigbee NFC driver, the driver will enter Touchlink mode and GP Mode.

Note: You can both have Touchlink and GP functions as long as you matched with Touchlink function first.

- Besides, you can re-power the device 4 times to enable this section as well.

### 4) Find & bind or delete GP

- This section as known as "Enable Find&Bind / Delete GP".
- Select this section and write it into the Zigbee NFC driver, the driver will enter Find&Bind mode, and it will delete previous GP bonding.
- Besides, you can re-power the device 3 times to enable this section as well.

With NFC Programming devices

**Note**

1) Do wiring according to the wiring diagram .

2) Recommend setting parameters without power-on devices .

2) Please make sure your mobile phone has NFC function and enable it .

**Working with “SR NFC Tool” APP**

**Step 1: Download the APP (searching “SR NFC Tool” from App Store and Google Playstore) . Then open the APP .**

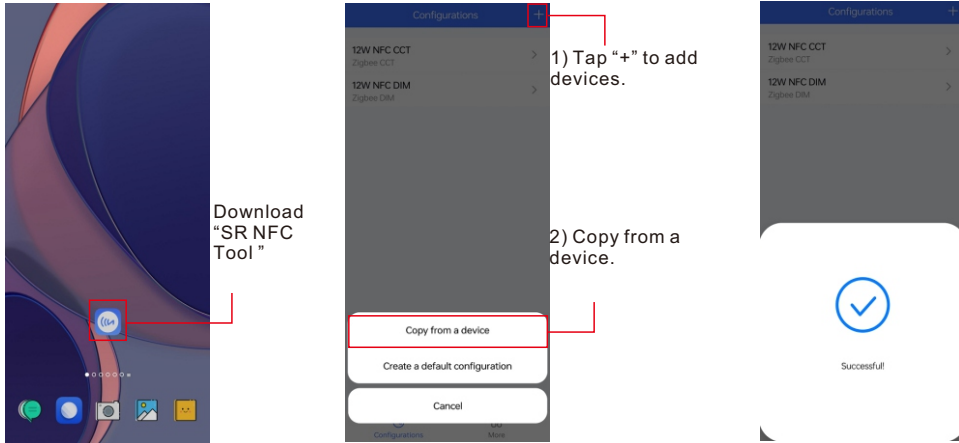

- Note:**
1. Please Make sure that you have enabled NFC function with your mobile phone/ tablet .
  2. Please Make sure that the “NFC position” is matched.
  3. Please do not power on the device before setting.
  4. If you can't download “SR NFC Tool”. Please contact with us.

**Step 2: Add device, and name it as you wish.**

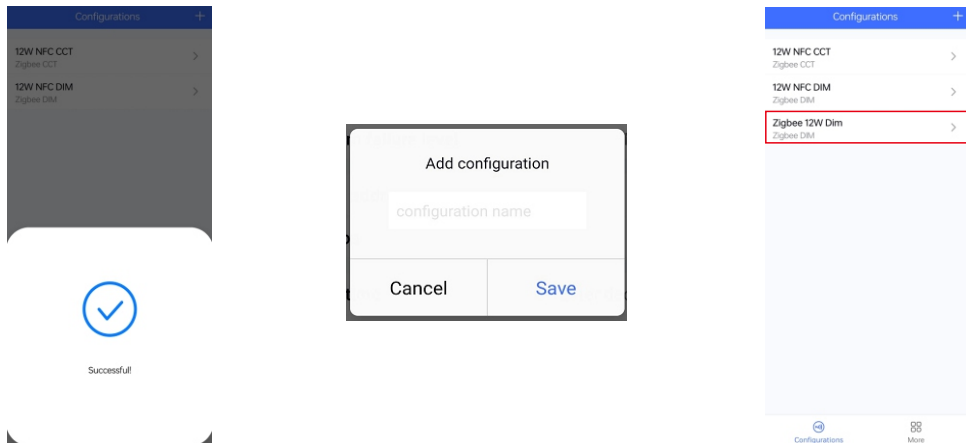

**Step 3: Unlock device, enter parameters configuring page.**

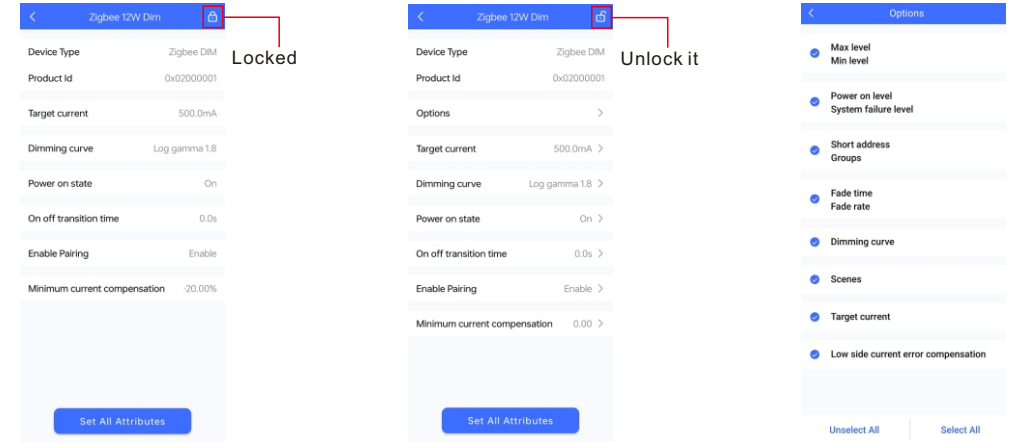

- Note:**
1. You have to unlock the device then do some settings
  2. Only when the corresponding function is selected, the function interface will be displayed.

**Step 4: Few parameter interface, you can choose the setting based on your requirements.**

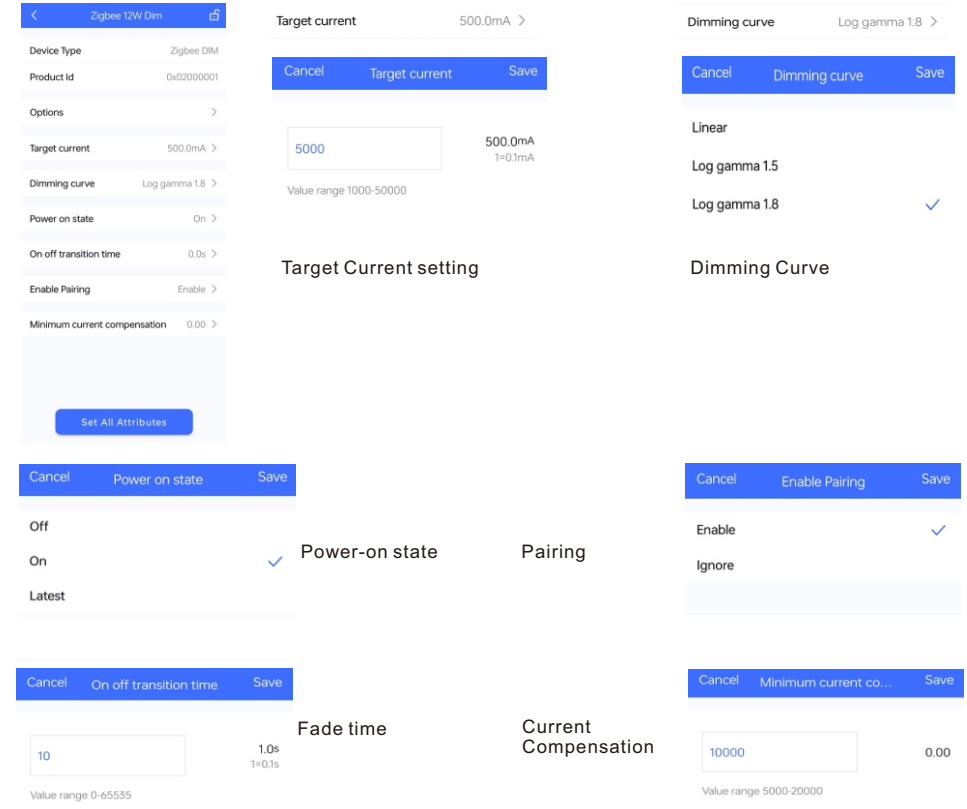

Target Current setting

Dimming Curve

Power-on state

Pairing

Fade time

Current Compensation

**Step 5: After setting, please save the selected configuration via NFC and power on the device.**

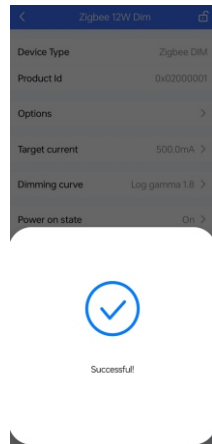
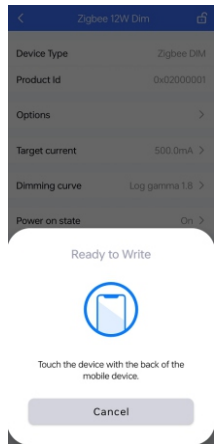

### Tips

1. NFC function doesn't require any power driver.
2. Many functions can be configured by NFC. Kindly check your desired functions.
3. You can create a default profile with the "+" button.

### Wiring Diagram

With single color LED luminaire

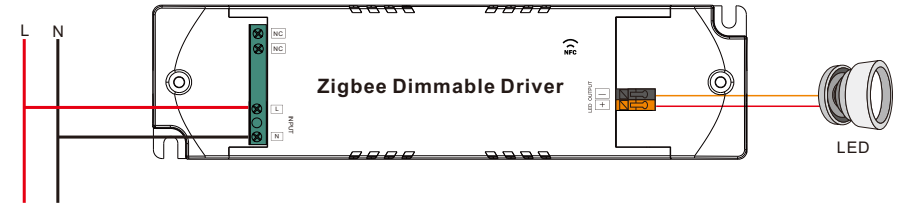

### Product Dimension

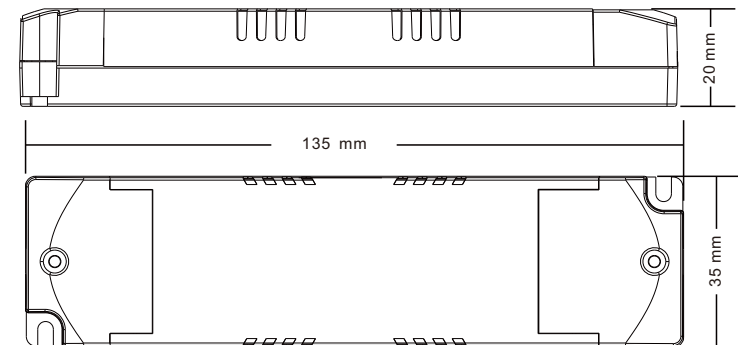

## Operating window

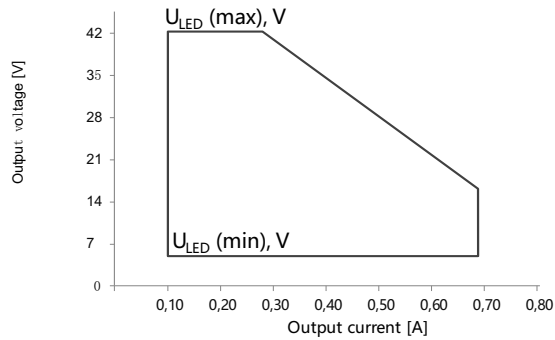

## Dimming Curve

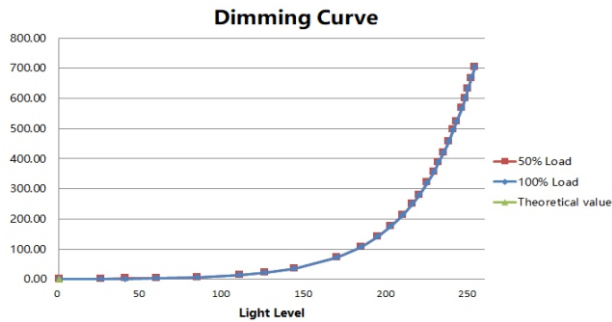

Note: Test data under 700mA gear

## Driver Performance

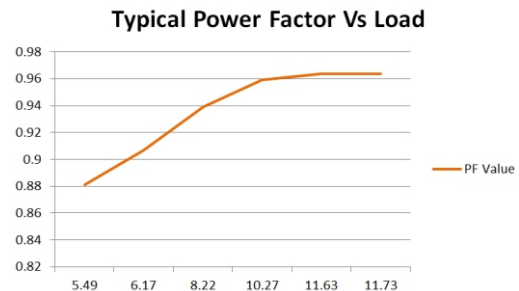

Note: Test data under 700mA gear

## Driver Performance

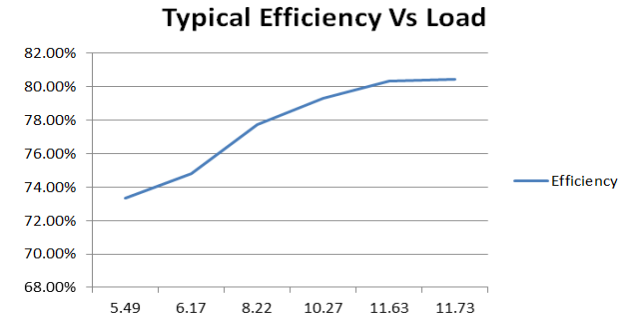

Note: Test data under 700mA gear

## MCB Load Quantity

Module Number	I <sub>peak</sub>	T <sub>width</sub>	Max. quantity of LED Driver per MCB														
			B10	B13	B16	B20	B25	C10	C13	C16	C20	C25	D10	D13	D16	D20	D25
214-260	3.96A	90μs	37	49	60	75	94	63	81	100	125	156	80	104	128	160	200

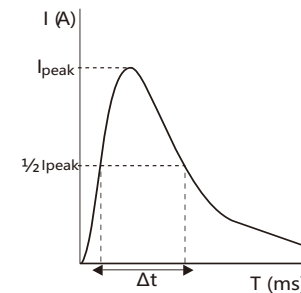

Note:

- 1.Those MCB parameters are based on ABB S200 series circuit breakers.
- 2.For different brands and models of miniature circuit breakers, the quantity of drivers will have difference.
- 3.Please do not exceed the above-mentioned quantity during on-site installation, and the specific load quantity shall be subject to on-site installation.
- 4.When the installation environment temperature of MCBs exceeds 30°C or when multiple MCBs are installed side by side, the number of mounted drives will be reduced, which requires recalculation.
- 5.Type C MCB's are strongly recommended to use with LED lighting

## Update log

Date	Version	Update content	Update by
2023-4-7	V1.1	Function Update	Romeo

Note: Subject to change without notice. Please contact us if you have any questions.