

MATERIALEN

Nummer	Omschrijving	Materiaal
1	Gevlochten slang	Silicone - AISI 304
2	Pershuls	AISI 304
3	Fitting	CW 617 N-DW UNI EN 12164
4	Tule	CW 617 N-DW UNI EN 12164
5	Pakking	EPDM
6	Wartel	CW 617 N UNI EN 12165



TECHNISCHE GEGEVENS

Algemeen	
Maximale druk	10 bar
Maximale bedrijfstemperatuur	70°C
Gewicht	?? gram
Lengte (L)	500 mm
Tolerantie (L)	20 mm
Certificaten	KIWA

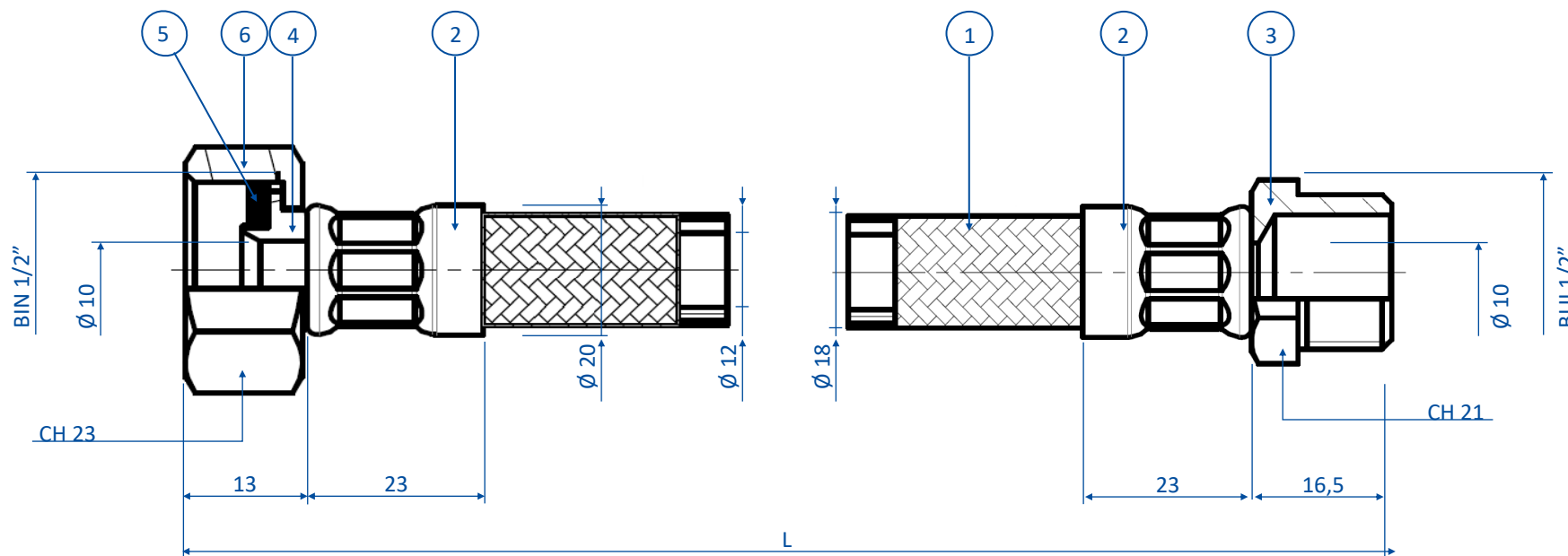

CH = Steeksleutelmaat