

Data Sheet | Item Number: 2250-304

2-conductor miniature through terminal block; with push-button; 1 mm²; End terminal block with mounting flange; side and center marking; with test port; Push-in CAGE CLAMP®; 1,00 mm²; blue



<https://www.wago.com/2250-304>



Color: ■ blue



Similar to illustration

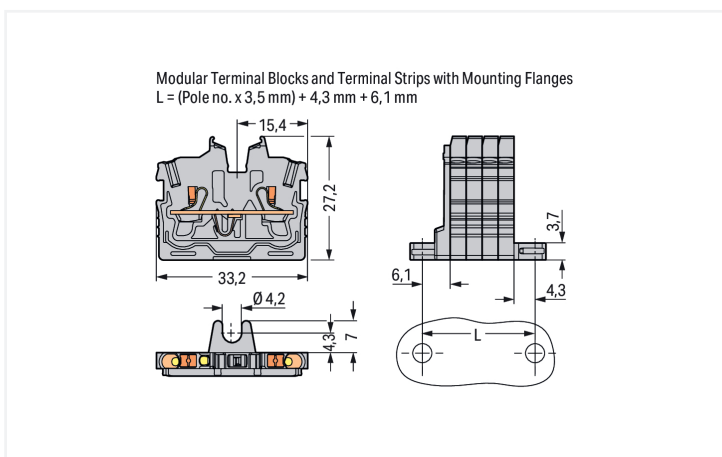

Through terminal block, 2250 Series, Push-in CAGE CLAMP®

Quick and easy connections are guaranteed with this through terminal block (item number 2250-304). Conductors can only be connected to this through terminal block if their strip length is between 9 and 11 mm . Our mini rail-mount terminal blocks are perfect for tight spaces thanks to their com-

compact design. You can also choose from a range of mounting and actuation variants for unparalleled flexibility, making it easy to select the ideal mini terminal block for each use. This product features conductor terminals and utilizes Push-in CAGE CLAMP®. Push-in CAGE CLAMP® technology provides a universal connection solution for any type of conductor. It allows both solid and fine-stranded conductors with ferrules to be inserted directly into the clamping point without the need for tools. This through terminal block is suitable for conductor cross sections ranging from 0.14 mm² to 1.5 mm².

A push-button is used to operate this mini rail-mount terminal block. Our TOPJOB® S rail-mount terminal blocks offer more than just secure electrical connections in all kinds of industrial applications and modern building installations. They also offer the perfect actuation variant for every use: lever, push-button, or operating slot. This product is designed for specific Ex applications (please refer to the product datasheet).

Electrical data

Ratings per	IEC/EN 60998-2-2		
Overvoltage category	III	III	II
Pollution degree	3	2	2
Nominal voltage	500 V	-	-
Rated impulse withstand voltage	6 kV	-	-
Rated current	13.5 A	-	-
Current at conductor cross-section (max.) mm ²	17.5 A	-	-

Approvals per	UL 1059		
Use group	B	C	D
Rated voltage	300 V	300 V	-
Rated current	10 A	10 A	-

Approvals per	CSA 22.2 No 158		
Use group	B	C	D
Rated voltage	300 V	300 V	-
Rated current	10 A	10 A	-

Ex information	
Reference to hazardous areas	See "Downloads – Documentation – Additional Information: Technical Section; Technical Explanations"
Ratings per	ATEX: PTB 19 ATEX 1019 U / IECEx: PTB 19.0050U (Ex eb IIC Gb)
Rated voltage EN (Ex e II)	352 V
Rated current (Ex e II)	13.5 A
Rated current (Ex e II) with jumper	12 A

Power Loss	
Power loss, per pole (potential)	0.4338 W
Rated current I _N for power loss specification	13.5 A
Resistance value for specified, current-dependent power loss	0.00238 Ω

General information	
Wiring direction	Front-entry wiring

Connection Data

Clamping units	2
Total number of potentials	1
Number of levels	1
Number of jumper slots	1

Connection 1	
Connection technology	Push-in CAGE CLAMP®
Actuation type	Push-button
Connectable conductor materials	Copper
Nominal cross-section	1 mm ²
Solid conductor	0.14 ... 1.5 mm ² / 24 ... 16 AWG
Solid conductor; push-in termination	0.5 ... 1.5 mm ² / 20 ... 16 AWG
Fine-stranded conductor	0.14 ... 1.5 mm ² / 24 ... 16 AWG
Fine-stranded conductor; with insulated ferrule	0.14 ... 1 mm ² / 24 ... 18 AWG
Fine-stranded conductor; with uninsulated ferrule	0.14 ... 1 mm ² / 24 ... 18 AWG
Fine-stranded conductor; with ferrule; push-in termination	0.5 ... 1 mm ² / 20 ... 18 AWG
Note (conductor cross-section)	Depending on the conductor characteristic, a conductor with a smaller cross-section can also be inserted via push-in termination.
Strip length	9 ... 11 mm / 0.35 ... 0.43 inches

Connection 1

Wiring direction	Front-entry wiring
------------------	--------------------

Physical data

Width	3.5 mm / 0.138 inches
Height from the surface	27.2 mm / 1.071 inches
Depth	33.2 mm / 1.307 inches

Mechanical data

Mounting type	Mounting flange
Marking level	Center/side marking

Material data

Note (material data)	Information on material specifications can be found here
Color	blue
Material group	I
Insulation material (main housing)	Polyamide (PA66)
Flammability class per UL94	V0
Fire load	0.054 MJ
Weight	2.4 g

Environmental requirements

Processing temperature	-35 ... +85 °C
Continuous operating temperature	-60 ... +105 °C

Commercial data

PU (SPU)	100 pcs
Packaging type	Box
Country of origin	IN
GTIN	4055143965712
Customs tariff number	85369010000

Product Classification

UNSPSC	39121410
ETIM 9.0	EC001284
ETIM 10.0	EC001284
ECCN	NO US CLASSIFICATION

Environmental Product Compliance

RoHS Compliance Status	Compliant, No Exemption
------------------------	-------------------------

Approvals / Certificates

General approvals



Approval	Standard	Certificate Name
CCA DEKRA Certification B.V.	EN 60998	NTR NL 7840
CSA CSA	C22.2 No. 158	80034182
cURus Underwriters Laboratories Inc.	UL 1059	E45172
KEMA/KEUR DEKRA Certification B.V.	EN 60998	71-113957

Declarations of conformity and manufacturer's declarations

Approval	Standard	Certificate Name
ATEX-Attestation of Conformity WAGO GmbH & Co. KG	-	-
EU-Declaration of Conformity WAGO GmbH & Co. KG	-	-
UK-Declaration of Conformity WAGO GmbH & Co. KG	-	-

Approvals for marine applications



Approval	Standard	Certificate Name
DNV DNV GL SE	-	TAE00003JT

Approvals for hazardous areas



Approval	Standard	Certificate Name
AEx Underwriters Laboratories Inc.	UL 60079	E185892 (AEx eb IIC resp. Ex eb IIC)
ATEX Physikalisch Technische Bundesanstalt	EN IEC 60079-0	PTB 19 ATEX 1019 U (II 2G Ex eb IIC Gb or I M 2 Ex eb I Mb)
CCC CNEX	GB/T 3836.3	2020312313000289 (Ex eb IIC Gb, Ex eb I Mb)
IECEX Physikalisch Technische Bundesanstalt	IEC 60079	IECEX PTB 19.0050U (Ex eb IIC Gb or EX eb I Mb)
INMETRO TÜV Rheinland do Brasil Ltda.	IEC 60079	TÜV 22.0014 U

Downloads

Environmental Product Compliance

Compliance Search

Environmental Product Compliance 2250-304



CAD/CAE-Data

CAD data

2D/3D Models
2250-304



CAE data

EPLAN Data Portal
2250-304



WSCAD Universe
2250-304



ZUKEN Portal
2250-304



1 Compatible Products

1.1 System counterpart

1.1.1 Through terminal block



Item No.: [2250-324](#)

2-conductor miniature through terminal block; with push-button; 1 mm²; Center terminal block without snap-in mounting foot, without mounting flange; side and center marking; with test port; Push-in CAGE CLAMP®; 1,00 mm²; blue

1.2 Required Accessories

1.2.1 End plate

1.2.1.1 End plate



Item No.: [2050-381](#)

End plate; with fixing flange; 1.3 mm thick; gray

1.3 Optional Accessories

1.3.1 Ferrule

1.3.1.1 Ferrule



Item No.: [216-241](#)

Ferrule; Sleeve for 0.5 mm² / 20 AWG; insulated; electro-tin plated; electrolytic copper; gastight crimped; acc. to DIN 46228, Part 4/09.90; white



Item No.: [216-242](#)

Ferrule; Sleeve for 0.75 mm² / 18 AWG; insulated; electro-tin plated; electrolytic copper; gastight crimped; acc. to DIN 46228, Part 4/09.90; gray



Item No.: [216-243](#)

Ferrule; Sleeve for 1 mm² / AWG 18; insulated; electro-tin plated; electrolytic copper; gastight crimped; acc. to DIN 46228, Part 4/09.90; red

1.3.2 Installation

1.3.2.1 Mounting accessories



Item No.: [209-137](#)

Mounting adapter; can be used as end stop; 6.5 mm wide; gray

1.3.3 Jumper

1.3.3.1 Jumper



[Item No.: 2000-406/020-000](#)
Delta jumper; insulated; light gray



[Item No.: 2000-410/000-006](#)
Jumper; 10-way; insulated; blue



[Item No.: 2000-410](#)
Jumper; 10-way; insulated; light gray



[Item No.: 2000-410/000-005](#)
Jumper; 10-way; insulated; red



[Item No.: 2000-402/000-006](#)
Jumper; 2-way; insulated; blue



[Item No.: 2000-402](#)
Jumper; 2-way; insulated; light gray



[Item No.: 2000-402/000-005](#)
Jumper; 2-way; insulated; red



[Item No.: 2000-402/000-018](#)
Jumper; 2-way; insulated; yellow-green



[Item No.: 2000-403/000-006](#)
Jumper; 3-way; insulated; blue



[Item No.: 2000-403](#)
Jumper; 3-way; insulated; light gray



[Item No.: 2000-403/000-005](#)
Jumper; 3-way; insulated; red



[Item No.: 2000-404/000-006](#)
Jumper; 4-way; insulated; blue



[Item No.: 2000-404](#)
Jumper; 4-way; insulated; light gray



[Item No.: 2000-404/000-005](#)
Jumper; 4-way; insulated; red



[Item No.: 2000-405/000-006](#)
Jumper; 5-way; insulated; blue



[Item No.: 2000-405](#)
Jumper; 5-way; insulated; light gray



[Item No.: 2000-405/000-005](#)
Jumper; 5-way; insulated; red



[Item No.: 2000-406/000-006](#)
Jumper; 6-way; insulated; blue



[Item No.: 2000-406](#)
Jumper; 6-way; insulated; light gray



[Item No.: 2000-406/000-005](#)
Jumper; 6-way; insulated; red



[Item No.: 2000-407/000-006](#)
Jumper; 7-way; insulated; blue



[Item No.: 2000-407](#)
Jumper; 7-way; insulated; light gray



[Item No.: 2000-407/000-005](#)
Jumper; 7-way; insulated; red



[Item No.: 2000-408/000-006](#)
Jumper; 8-way; insulated; blue



[Item No.: 2000-408](#)
Jumper; 8-way; insulated; light gray



[Item No.: 2000-408/000-005](#)
Jumper; 8-way; insulated; red



[Item No.: 2000-409/000-006](#)
Jumper; 9-way; insulated; blue



[Item No.: 2000-409](#)
Jumper; 9-way; insulated; light gray



[Item No.: 2000-409/000-005](#)
Jumper; 9-way; insulated; red



[Item No.: 2000-440](#)
Jumper; from 1 to 10; insulated; light gray



[Item No.: 2000-433/000-006](#)
Jumper; from 1 to 3; insulated; blue



[Item No.: 2000-433](#)
Jumper; from 1 to 3; insulated; light gray



[Item No.: 2000-433/000-005](#)
Jumper; from 1 to 3; insulated; red



[Item No.: 2000-434](#)
Jumper; from 1 to 4; insulated; light gray



[Item No.: 2000-435](#)
Jumper; from 1 to 5; insulated; light gray



[Item No.: 2000-436](#)
Jumper; from 1 to 6; insulated; light gray



[Item No.: 2000-437](#)
Jumper; from 1 to 7; insulated; light gray



[Item No.: 2000-438](#)
Jumper; from 1 to 8; insulated; light gray



[Item No.: 2000-439](#)
Jumper; from 1 to 9; insulated; light gray



[Item No.: 2000-405/011-000](#)
Star point jumper; 3-way; insulated; light gray

1.3.4 Marking

1.3.4.1 Group marker carrier



[Item No.: 2009-191](#)
Group marker carrier; gray

1.3.4.2 Marker



Item No.: 793-3501
WMB marking card; as card; plain; snap-on type; white

Item No.: 2009-113/000-006
WMB-Inline; for Smart Printer; 2300 pieces on roll; plain; snap-on type; blue

Item No.: 2009-113/000-007
WMB-Inline; for Smart Printer; 2300 pieces on roll; plain; snap-on type; gray

Item No.: 2009-113/000-023
WMB-Inline; for Smart Printer; 2300 pieces on roll; plain; snap-on type; green



Item No.: 2009-113/000-017
WMB-Inline; for Smart Printer; 2300 pieces on roll; plain; snap-on type; light green

Item No.: 2009-113/000-012
WMB-Inline; for Smart Printer; 2300 pieces on roll; plain; snap-on type; orange

Item No.: 2009-113/000-005
WMB-Inline; for Smart Printer; 2300 pieces on roll; plain; snap-on type; red

Item No.: 2009-113/000-024
WMB-Inline; for Smart Printer; 2300 pieces on roll; plain; snap-on type; violet



Item No.: 2009-113
WMB-Inline; for Smart Printer; 2300 pieces on roll; plain; snap-on type; white

Item No.: 2009-113/000-002
WMB-Inline; for Smart Printer; 2300 pieces on roll; plain; snap-on type; yellow

1.3.4.3 Marking strip



Item No.: 2009-110
Marking strips; for Smart Printer; on reel; not stretchable; plain; snap-on type; white

1.3.5 Push-in type wire jumper

1.3.5.1 Jumper



Item No.: 2009-404
Push-in type wire jumper; 0.75 mm²; insulated; 110 mm long; gray

Item No.: 2009-406
Push-in type wire jumper; 0.75 mm²; insulated; 250 mm long; gray

Item No.: 2009-402
Push-in type wire jumper; 0.75 mm²; insulated; 60 mm long; gray

1.3.6 Test and measurement

1.3.6.1 Testing accessories



Item No.: 2009-174
Test plug adapter; for 4 mm Ø test plugs; for testing TOPJOB®S rail-mounted terminal blocks; gray

Item No.: 210-136
Test plug; 2 mm Ø; with 500 mm cable; red

Item No.: 2009-182
Testing tap; for max. 2.5 mm²; tool-free connection for individual test wires 0.08 - 2.5 mm; gray

1.3.7 Tool

1.3.7.1 Operating tool



Item No.: 210-719
Operating tool; Blade: 2.5 x 0.4 mm; with a partially insulated shaft

Item No.: 210-648
Operating tool; Blade: 2.5 x 0.4 mm; with a partially insulated shaft; angled; short

Item No.: 210-647
Operating tool; Blade: 2.5 x 0.4 mm; with a partially insulated shaft; multicoloured

Installation Notes

Installation

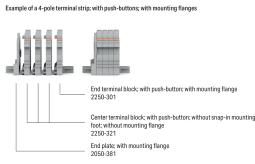

Conductor termination



Insert solid conductors via push-in termination.



Insert ferruled conductors via push-in termination.

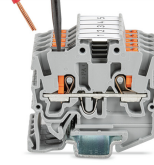

Insert fine-stranded conductors via operating tool.

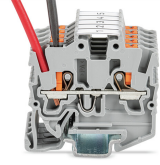

Remove all conductors via operating tool.

Commoning

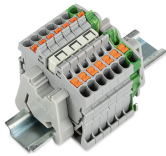

Insert a delta jumper and push down until it hits the backstop (example shows terminal blocks with push-buttons).

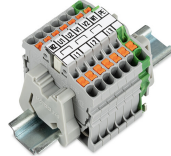

Marking strip (Item No. 2009-110) inserted in the marking slot with jumper symbols of the inserted jumper (delta jumper) (example shows terminal blocks with push-buttons)



Insert a star point jumper and push down until it hits the backstop (example shows terminal blocks with push-buttons).

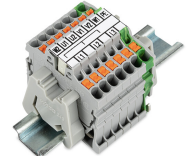

Marking strip (Item No. 2009-110) inserted in the marking slot with jumper symbols of the inserted jumper (2000-405/011-000 Delta Jumper) (example shows terminal blocks with push-buttons)

Testing



Testing with a 2 mm Ø 210-136 Test Plug (max. 42 V).

Installation

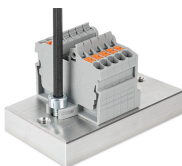

Mounting and securing a terminal strip directly to the plate via screw-type flanges (example shows terminal blocks with push-buttons).

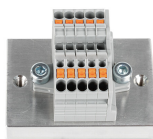

Terminal strip; with mounting flanges; screw mounting (example shows terminal blocks with push-buttons)

Marking



Snapping a marking strip into the marker slot.



Snapping a marking strip (Item No. 2009-110) into a marker slot.