

Data Sheet | Item Number: 2250-324

2-conductor miniature through terminal block; with push-button; 1 mm²; Center terminal block without snap-in mounting foot, without mounting flange; side and center marking; with test port; Push-in CAGE CLAMP®; 1,00 mm²; blue

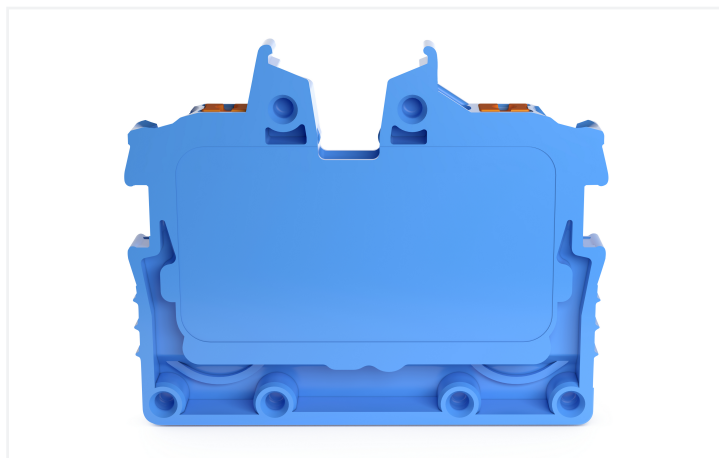

<https://www.wago.com/2250-324>



Color: ■ blue

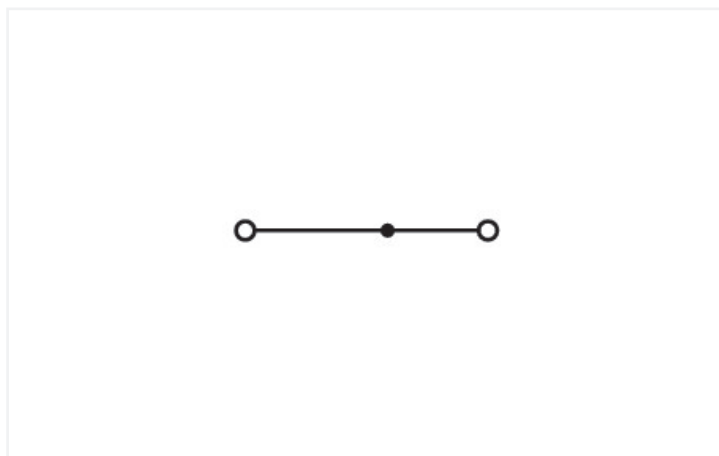
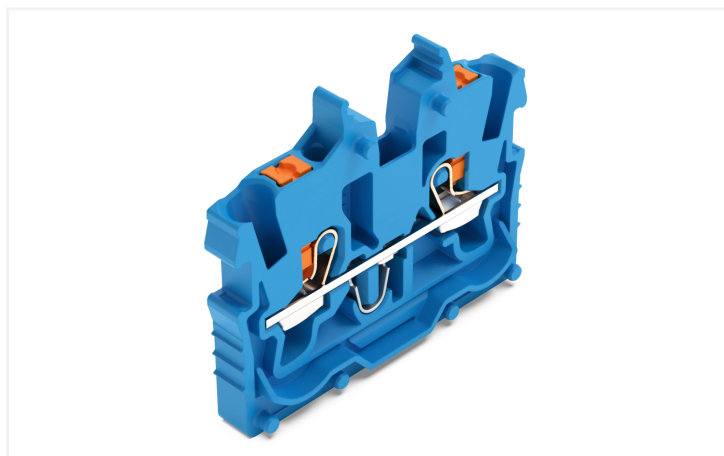

Similar to illustration

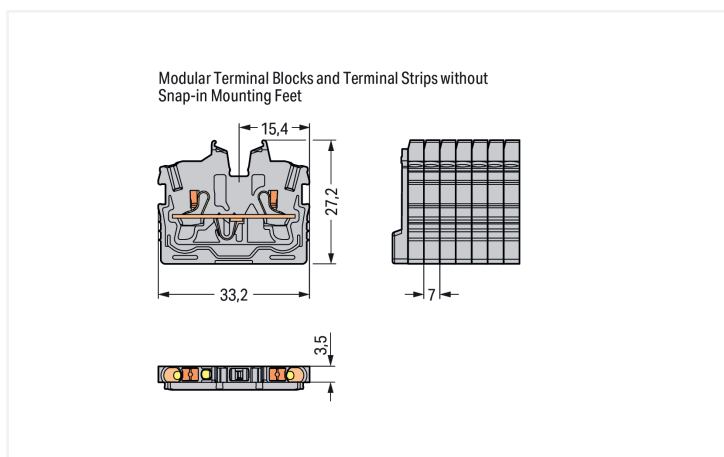

Through terminal block, 2250 Series, push-button

Quick and easy connections are guaranteed with this through terminal block (item number 2250-324). Conductors should only be connected to this through terminal block if their strip length is between 9 and 11 mm . Whether for industrial or building applications, you can use our through terminal

blocks to connect electrical conductors quickly and safely. We offer variants for both classic through-wiring and potential distribution. Featuring conductor terminals along with Push-in CAGE CLAMP®, this connector is highly versatile. Push-in CAGE CLAMP® technology provides a universal connection solution for any type of conductor. It allows both solid and fine-stranded conductors with ferrules to be inserted directly into the clamping point without the need for tools. This through terminal block is suitable for conductor cross sections ranging from 0.14 mm² to 1.5 mm².

This mini rail-mount terminal block is operated with a push-button. Our TOPJOB® S rail-mount terminal blocks guarantee reliable electrical connections across many industrial applications and modern building installations. They make wiring work easier as you can quickly plug in solid, stranded, and fine-stranded conductors with ferrules. This product is designed for specific Ex applications (please refer to the product datasheet).

Electrical data

Ratings per	IEC/EN 60998-2-2			Approvals per	UL 1059		
Overvoltage category	III	III	II	Use group	B	C	D
Pollution degree	3	2	2	Rated voltage	300 V	300 V	-
Nominal voltage	500 V	-	-	Rated current	10 A	10 A	-
Rated impulse withstand voltage	6 kV	-	-				
Rated current	13.5 A	-	-				
Current at conductor cross-section (max.) mm ²	17.5 A	-	-				

Approvals per	CSA 22.2 No 158		
Use group	B	C	D
Rated voltage	300 V	300 V	-
Rated current	10 A	10 A	-

Ex information	
Reference to hazardous areas	See "Downloads – Documentation – Additional Information: Technical Section; Technical Explanations"
Ratings per	ATEX: PTB 19 ATEX 1019 U / IECEx: PTB 19.0050U (Ex eb IIC Gb)
Rated voltage EN (Ex e II)	352 V
Rated current (Ex e II)	13.5 A
Rated current (Ex e II) with jumper	12 A

Power Loss	
Rated current I _N for power loss specification	13.5 A
Resistance value for specified, current-dependent power loss	0.00238 Ω

General information	
Wiring direction	Front-entry wiring

Connection Data

Clamping units	2
Total number of potentials	1
Number of levels	1
Number of jumper slots	1

Connection 1	
Connection technology	Push-in CAGE CLAMP®
Actuation type	Push-button
Connectable conductor materials	Copper
Nominal cross-section	1 mm ²
Solid conductor	0.14 ... 1.5 mm ² / 24 ... 16 AWG
Solid conductor; push-in termination	0.5 ... 1.5 mm ² / 20 ... 16 AWG
Fine-stranded conductor	0.14 ... 1.5 mm ² / 24 ... 16 AWG
Fine-stranded conductor; with insulated ferrule	0.14 ... 1 mm ² / 24 ... 18 AWG
Fine-stranded conductor; with uninsulated ferrule	0.14 ... 1 mm ² / 24 ... 18 AWG
Fine-stranded conductor; with ferrule; push-in termination	0.5 ... 1 mm ² / 20 ... 18 AWG
Note (conductor cross-section)	Depending on the conductor characteristic, a conductor with a smaller cross-section can also be inserted via push-in termination.
Strip length	9 ... 11 mm / 0.35 ... 0.43 inches
Wiring direction	Front-entry wiring

Physical data

Width	3.5 mm / 0.138 inches
Height from the surface	27.2 mm / 1.071 inches
Depth	33.2 mm / 1.307 inches

Mechanical data

Mounting type	without snap-in mounting feet
Marking level	Center/side marking

Material data

Note (material data)	Information on material specifications can be found here
Color	blue
Material group	I
Insulation material (main housing)	Polyamide (PA66)
Flammability class per UL94	V0
Fire load	0.055 MJ
Weight	2.4 g

Environmental requirements

Processing temperature	-35 ... +85 °C
Continuous operating temperature	-60 ... +105 °C

Commercial data

PU (SPU)	100 pcs
Packaging type	Box
Country of origin	IN
GTIN	4055143965651
Customs tariff number	85369010000

Product Classification

UNSPSC	39121410
ETIM 9.0	EC001284
ETIM 10.0	EC001284
ECCN	NO US CLASSIFICATION

Environmental Product Compliance

RoHS Compliance Status	Compliant, No Exemption
------------------------	-------------------------

Approvals / Certificates

General approvals



Approval	Standard	Certificate Name
CCA DEKRA Certification B.V.	EN 60998	NTR NL 7840
CSA CSA	C22.2 No. 158	80034182

General approvals

cURus Underwriters Laboratories Inc.	UL 1059	E45172
KEMA/KEUR DEKRA Certification B.V.	EN 60998	71-113957

Declarations of conformity and manufacturer's declarations

Approval	Standard	Certificate Name
ATEX-Attestation of Conformity WAGO GmbH & Co. KG	-	-
EU-Declaration of Conformity WAGO GmbH & Co. KG	-	-
UK-Declaration of Conformity WAGO GmbH & Co. KG	-	-

Approvals for marine applications



Approval	Standard	Certificate Name
DNV DNV GL SE	-	TAE00003JT

Approvals for hazardous areas



Approval	Standard	Certificate Name
ATEX Physikalisch Technische Bundesanstalt	EN IEC 60079-0	PTB 19 ATEX 1019 U (II 2G Ex eb IIC Gb or I M 2 Ex eb I Mb)
CCC CNEX	GB/T 3836.3	2020312313000289 (Ex eb IIC Gb, Ex eb I Mb)
IECEX Physikalisch Technische Bundesanstalt	IEC 60079	IECEX PTB 19.0050U (Ex eb IIC Gb or EX eb I Mb)
INMETRO TÜV Rheinland do Brasil Ltda.	IEC 60079	TÜV 22.0014 U

Downloads

Environmental Product Compliance

Compliance Search
Environmental Product Compliance 2250-324 ↓

CAD/CAE-Data

CAD data
2D/3D Models 2250-324 ↓

CAE data
EPLAN Data Portal 2250-324 ↓
WSCAD Universe 2250-324 ↓
ZUKEN Portal 2250-324 ↓

1 Compatible Products

1.1 Required Accessories

1.1.1 End plate

1.1.1.1 End plate



Item No.: 2050-381
End plate; with fixing flange; 1.3 mm thick; gray

1.2 Optional Accessories

1.2.1 Ferrule

1.2.1.1 Ferrule



Item No.: 216-241
Ferrule; Sleeve for 0.5 mm² / 20 AWG; insulated; electro-tin plated; electrolytic copper; gastight crimped; acc. to DIN 46228, Part 4/09.90; white



Item No.: 216-242
Ferrule; Sleeve for 0.75 mm² / 18 AWG; insulated; electro-tin plated; electrolytic copper; gastight crimped; acc. to DIN 46228, Part 4/09.90; gray



Item No.: 216-243
Ferrule; Sleeve for 1 mm² / AWG 18; insulated; electro-tin plated; electrolytic copper; gastight crimped; acc. to DIN 46228, Part 4/09.90; red

1.2.2 Jumper

1.2.2.1 Jumper



Item No.: 2000-406/020-000
Delta jumper; insulated; light gray



Item No.: 2000-410/000-006
Jumper; 10-way; insulated; blue



Item No.: 2000-410
Jumper; 10-way; insulated; light gray



Item No.: 2000-410/000-005
Jumper; 10-way; insulated; red



Item No.: 2000-402/000-006
Jumper; 2-way; insulated; blue



Item No.: 2000-402
Jumper; 2-way; insulated; light gray



Item No.: 2000-402/000-005
Jumper; 2-way; insulated; red



Item No.: 2000-402/000-018
Jumper; 2-way; insulated; yellow-green



Item No.: 2000-403/000-006
Jumper; 3-way; insulated; blue



Item No.: 2000-403
Jumper; 3-way; insulated; light gray



Item No.: 2000-403/000-005
Jumper; 3-way; insulated; red



Item No.: 2000-404/000-006
Jumper; 4-way; insulated; blue



Item No.: 2000-404
Jumper; 4-way; insulated; light gray



Item No.: 2000-404/000-005
Jumper; 4-way; insulated; red



Item No.: 2000-405/000-006
Jumper; 5-way; insulated; blue



Item No.: 2000-405
Jumper; 5-way; insulated; light gray



Item No.: 2000-405/000-005
Jumper; 5-way; insulated; red



Item No.: 2000-406/000-006
Jumper; 6-way; insulated; blue



Item No.: 2000-406
Jumper; 6-way; insulated; light gray



Item No.: 2000-406/000-005
Jumper; 6-way; insulated; red



Item No.: 2000-407/000-006
Jumper; 7-way; insulated; blue



Item No.: 2000-407
Jumper; 7-way; insulated; light gray



Item No.: 2000-407/000-005
Jumper; 7-way; insulated; red



Item No.: 2000-408/000-006
Jumper; 8-way; insulated; blue



Item No.: 2000-408
Jumper; 8-way; insulated; light gray



Item No.: 2000-408/000-005
Jumper; 8-way; insulated; red



Item No.: 2000-409/000-006
Jumper; 9-way; insulated; blue



Item No.: 2000-409
Jumper; 9-way; insulated; light gray



Item No.: 2000-409/000-005
Jumper; 9-way; insulated; red



Item No.: 2000-440
Jumper; from 1 to 10; insulated; light gray



Item No.: 2000-433/000-006
Jumper; from 1 to 3; insulated; blue



Item No.: 2000-433
Jumper; from 1 to 3; insulated; light gray

1.2.2.1 Jumper



Item No.: 2000-433/000-005
Jumper; from 1 to 3; insulated; red

Item No.: 2000-434
Jumper; from 1 to 4; insulated; light gray

Item No.: 2000-435
Jumper; from 1 to 5; insulated; light gray

Item No.: 2000-436
Jumper; from 1 to 6; insulated; light gray



Item No.: 2000-437
Jumper; from 1 to 7; insulated; light gray

Item No.: 2000-438
Jumper; from 1 to 8; insulated; light gray

Item No.: 2000-439
Jumper; from 1 to 9; insulated; light gray

Item No.: 2000-405/011-000
Star point jumper; 3-way; insulated; light gray

1.2.3 Marking

1.2.3.1 Group marker carrier



Item No.: 2009-191
Group marker carrier; gray

1.2.3.2 Marker



Item No.: 793-3501
WMB marking card; as card; plain; snap-on type; white



Item No.: 2009-113/000-006
WMB-Inline; for Smart Printer; 2300 pieces on roll; plain; snap-on type; blue



Item No.: 2009-113/000-007
WMB-Inline; for Smart Printer; 2300 pieces on roll; plain; snap-on type; gray



Item No.: 2009-113/000-023
WMB-Inline; for Smart Printer; 2300 pieces on roll; plain; snap-on type; green



Item No.: 2009-113/000-017
WMB-Inline; for Smart Printer; 2300 pieces on roll; plain; snap-on type; light green



Item No.: 2009-113/000-012
WMB-Inline; for Smart Printer; 2300 pieces on roll; plain; snap-on type; orange



Item No.: 2009-113/000-005
WMB-Inline; for Smart Printer; 2300 pieces on roll; plain; snap-on type; red



Item No.: 2009-113/000-024
WMB-Inline; for Smart Printer; 2300 pieces on roll; plain; snap-on type; violet



Item No.: 2009-113
WMB-Inline; for Smart Printer; 2300 pieces on roll; plain; snap-on type; white



Item No.: 2009-113/000-002
WMB-Inline; for Smart Printer; 2300 pieces on roll; plain; snap-on type; yellow

1.2.3.3 Marking strip



Item No.: 2009-110
Marking strips; for Smart Printer; on reel; not stretchable; plain; snap-on type; white

1.2.4 Push-in type wire jumper

1.2.4.1 Jumper



Item No.: 2009-404
Push-in type wire jumper; 0.75 mm²; insulated; 110 mm long; gray



Item No.: 2009-406
Push-in type wire jumper; 0.75 mm²; insulated; 250 mm long; gray



Item No.: 2009-402
Push-in type wire jumper; 0.75 mm²; insulated; 60 mm long; gray

1.2.5 Test and measurement

1.2.5.1 Testing accessories



Item No.: 2009-174

Test plug adapter; for 4 mm Ø test plugs; for testing TOPJOB®S rail-mounted terminal blocks; gray



Item No.: 210-136

Test plug; 2 mm Ø; with 500 mm cable; red



Item No.: 2009-182

Testing tap; for max. 2.5 mm²; tool-free connection for individual test wires 0.08 - 2.5 mm; gray

1.2.6 Tool

1.2.6.1 Operating tool



Item No.: 210-719

Operating tool; Blade: 2.5 x 0.4 mm; with a partially insulated shaft



Item No.: 210-648

Operating tool; Blade: 2.5 x 0.4 mm; with a partially insulated shaft; angled; short



Item No.: 210-647

Operating tool; Blade: 2.5 x 0.4 mm; with a partially insulated shaft; multicoloured

Installation Notes

Installation

Example of a 4-pole terminal strip; with push-buttons; with mounting flange

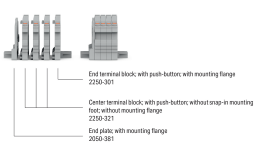

Example of a 5-pole terminal strip; with push-buttons; with snap-in mounting feet
Pole number = 2

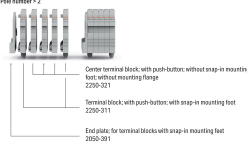

Conductor termination



Insert solid conductors via push-in termination.



Insert ferruled conductors via push-in termination.

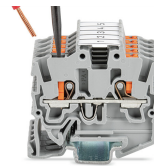

Insert fine-stranded conductors via operating tool.

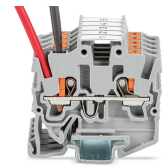

Remove all conductors via operating tool.

Commoning

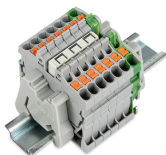

Insert a delta jumper and push down until it hits the backstop (example shows terminal blocks with push-buttons).

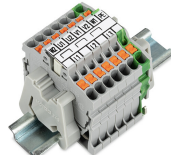

Marking strip (Item No. 2009-110) inserted in the marking slot with jumper symbols of the inserted jumper (delta jumper) (example shows terminal blocks with push-buttons)

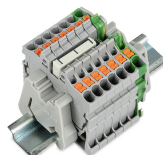

Insert a star point jumper and push down until it hits the backstop (example shows terminal blocks with push-buttons).

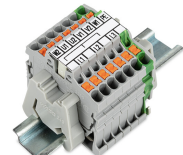

Marking strip (Item No. 2009-110) inserted in the marking slot with jumper symbols of the inserted jumper (2000-405/011-000 Delta Jumper) (example shows terminal blocks with push-buttons)

Testing



Testing with a 2 mm Ø 210-136 Test Plug (max. 42 V).

Installation

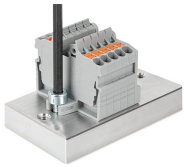

Mounting and securing a terminal strip directly to the plate via screw-type flanges (example shows terminal blocks with push-buttons).

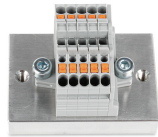

Terminal strip; with mounting flanges; screw mounting (example shows terminal blocks with push-buttons)

Installation



Mounting a terminal strip with snap-in feet into holes.



Mounting a terminal strip with snap-in feet onto aluminum rail.

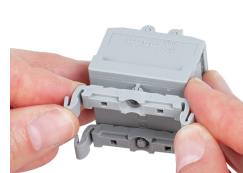

Snapping a mounting foot (209-120) to a terminal strip with snap-in mounting feet.
(Distance between mounting feet: approx. 20 ... 25 mm)

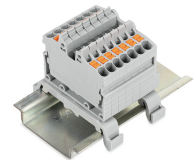

Terminal strip; with snap-in mounting feet; for DIN-35 rail (209-120 Mounting Foot) (example shows terminal blocks with push-buttons)

Marking



Snapping a marking strip into the marker slot.



Snapping a marking strip (Item No. 2009-110) into a marker slot.