

Productinformatieblad

Specificaties



Enkelvoudig contactblok met behuizingsbevestigingskraag, Harmony XB5, Plastic, 2 NC, compacte Push-in , verpakking van 100

ZB5AZ1045S61

EAN Code: 3389119074223

Hoofd

range of product	Harmony XB5
product or component type	Volledige montage lichaam/contact
device short name	ZB5
materiaal bevestigingskraag	Kunststof
verkoop per ondeelbare hoeveelheid	1
koptype	Standaard
type en samenstelling contacten	2 NC
werking contacten	Slow-break
type contactblok	Enkelvoudig
aansluitingen - aansluitklemmen	Insteek, $\leq 2 \times 1,5 \text{ mm}^2$ met kabeluiteinde met aansluitflensbus conform aan IEC 60947-1 Insteek, $\geq 1 \times 0,34 \text{ mm}^2$ zonder draadeinddop conform aan IEC 60947-1

Complementair

CAD totale breedte	46,2 mm
CAD totale hoogte	27,6 mm
CAD totale diepte	30 mm
beschrijving klemmen ISO n°1	(11-12)NC
net weight	0,016 kg
samenstelling apparaat	Behuizing Bevestigingskraag
contact gebruik	Standaardcontacten
positieve opening	Met conform aan IEC 60947-5-1 appendix K
bedrijfstraject	1,217 mm (normaal gesloten elektrische status wijzigen) 4,3 mm (totale reis)
bedieningskracht	4,5 N normaal gesloten elektrische status wijzigen
mechanical durability	10000000 cycles
contact materiaal	Zilverlegering (Ag/Ni)
kortsluitbeveiliging	10 A smeltpatroon type gG conform aan IEC 60947-5-1
lth conventionele thermische stroom in vrije lucht	10 A conform aan IEC 60947-5-1
Ui nom isolatiespanning	300 V (vervuilingsgraad 3) conform aan IEC 60947-1

De weergegeven prijs is de adviesprijs in euro excl. BTW. Deze kan onderhevig zijn aan korting. Neem contact op met uw lokale distributeur of detailhandel voor de daadwerkelijke prijs

Uimp nom. schokgolfspanning	4 kV conform aan IEC 60947-1
le nom. bedrijfstrom	6 A bij 120 V, AC-15, A300 conform aan IEC 60947-5-1 3 A bij 240 V, AC-15, A300 conform aan IEC 60947-5-1 0,55 A bij 125 V, DC-13, Q300 conform aan IEC 60947-5-1 0,27 A bij 250 V, DC-13, Q300 conform aan IEC 60947-5-1
product presentatie	Basis sub-eenheden

Omgeving

beschermende behandeling	TH
ambient air temperature for storage	-40...70 °C
ambient air temperature for operation	-40...70 °C
IP beschermingsgraad	IP20 conform aan IEC 60529
standards	IEC 60947-1 IEC 60947-5-1 IEC 60947-5-4 IEC 60947-5-5 UL 60947-1 UL 60947-5-1 UL 60947-5-5 UL 1059 UL 486E CSA C22.2 Nr 60947-1 CSA C22.2 Nr 60947-5-1 CSA C22.2 Nr. 158 CSA C22.2 Nr 65 IACS E10
product certifications	EAC ECEE CB-regeling CCC UL CSA
trilling bestendigheid	5 gn (f= 10...500 Hz) conforming to IEC 60068-2-6 25 mm piek-piek (f= 2...10 Hz) conforming to IEC 60068-2-6
schokbestendigheid	25 gn (duur = 6 ms) voor 1000 schokken op elke as conform aan IEC 60068-2-27 30 gn (duur = 18 ms) voor halve sinusgolf versnelling conform aan IEC 60068-2-27 50 gn (duur = 11 ms) voor halve sinusgolf versnelling conform aan IEC 60068-2-27

Verpakkingseenheid

Unit Type of Package 1	PCE
Number of Units in Package 1	1
Package 1 Height	3,000 cm
Package 1 Width	3,100 cm
Package 1 Length	4,300 cm
Package 1 Weight	24,000 g
Unit Type of Package 2	S02
Number of Units in Package 2	100
Package 2 Height	15,000 cm
Package 2 Width	30,000 cm
Package 2 Length	40,000 cm
Package 2 Weight	2,738 kg

Environmental Data

Schneider Electric wil tegen 2050 de Net Zero-status hebben bereikt via partnerschappen in de toeleveringsketen, materialen met een lagere impact en circulariteit via onze doorlopende campagne "Use Better, Use Longer, Use Again" om de levensduur van producten en de recycleerbaarheid te verlengen.

[Uitleg van Environmental Data](#) >

[Hoe evalueren we de duurzaamheid van producten?](#) >

Milieuoetafdruk

Totale levenscyclus ecologische voetafdruk 1

Milieuprofiel van product (PEP) [Milieuprofiel van het product](#)

Use Better

Materialen en verpakking

Pakket met gerecycleerd karton Ja

Verpakkingen zonder kunststof Nee

[EU-richtlijn RoHS](#)

Voldoet pro-actief (Product valt niet onder de EU RoHS juridische scope)

REACH-regelgeving

[REACH-verklaring](#)

Use Again

Herverpakken en herfabriceren

Circulair Profiel [Informatie over einde levensduur](#)

Terugname No

WEEE Label



Het product moet op markten van de Europese Unie worden afgevoerd volgens specifieke afvalinzamelingsregels en mag nooit in een gewone vuilnisbak terechtkomen.

Dimensions Drawings

Dimensions

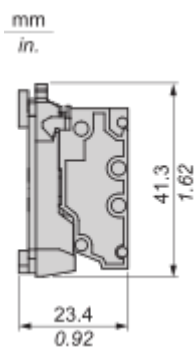

Mounting and Clearance

Mounting

Mounting and Unmounting

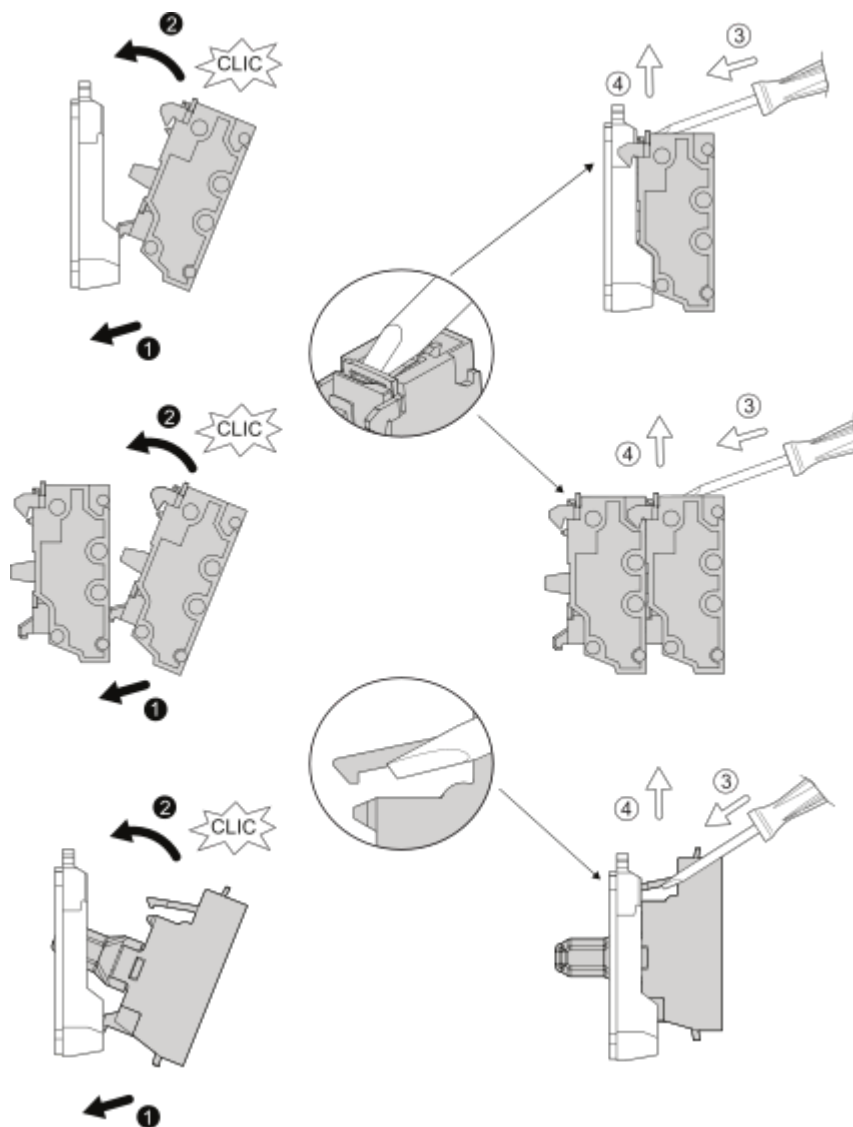

Panel cut-out Dimension

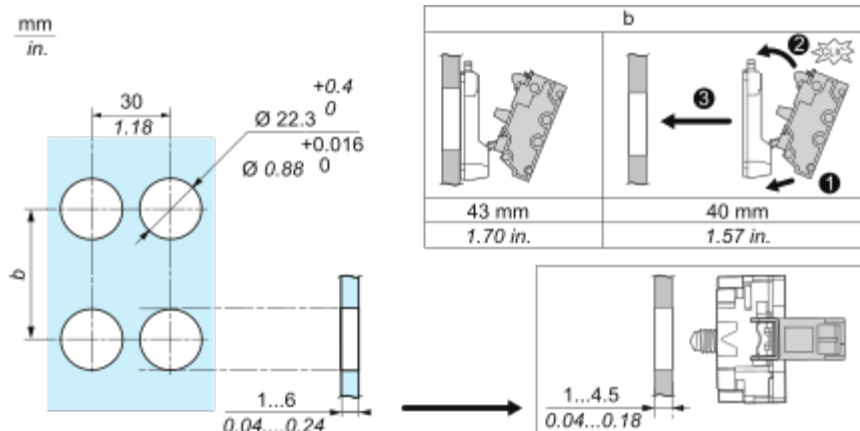

Connections and Schema

Wiring

Wiring and Unwiring



mm	8
in.	0.32
mm ²	0.34...1.5
AWG	22...16

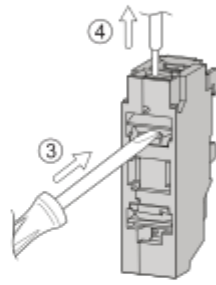
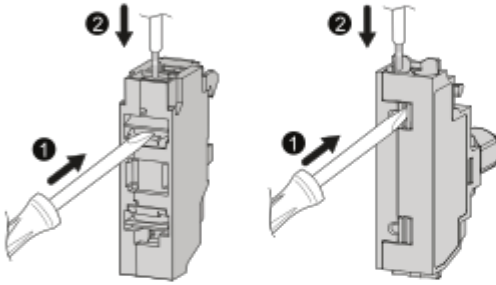
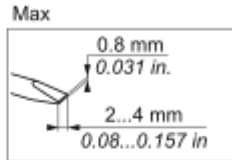

mm	8	8	8
in.	0.32	0.32	0.32
mm ²	0.34...1.5	0.34...1	0.34...1.5
AWG	22...16	22...18	22...16

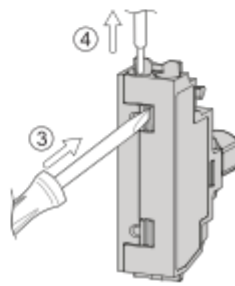
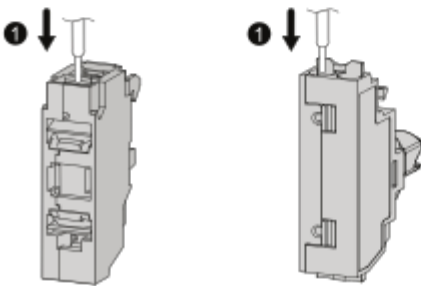

Technical Illustration

Dimensions

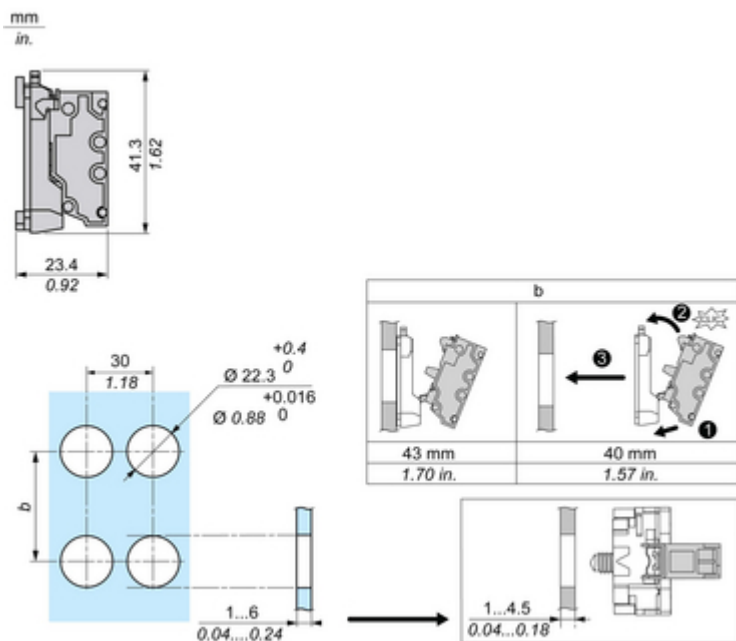

Technical Illustration

Wiring diagram

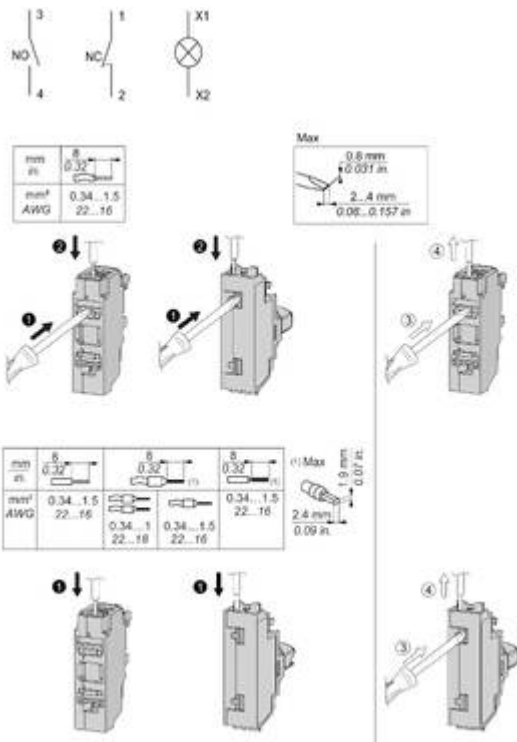

Offer Marketing Illustration

Product benefits / Features

Technical Benefits

Harmony XB4/XB5 Compact Push-in blocks

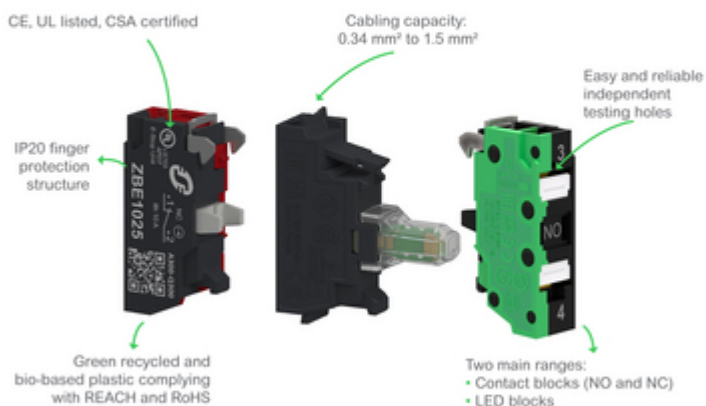

Offer Marketing Illustration

Product benefits / Features

Features
Harmony XB4/XB5 Compact Push-in blocks



37% thinner than a standard block

Installation costs saved through reduced wiring time and effort

Fully compatible with current Harmony offer

Available as single block, sub-assemblies and complete units (both plastic and metal ranges)

Simplified inventory management

Offer Marketing Illustration

Product benefits / Features

Features Harmony XB5



- 

Quick and easy assembly and disassembly
- 

Excellent mechanical connection with operator head
- 

Various types of connection: screw clamp, connector, Faston connector, spring terminal, or printed circuit board
- 

Large set of accessories to customize your panels
- 

Robustness to withstand harsh environments

Offer Marketing Illustration

Product benefits / Features

Technical Benefits

Harmony XB5

Conformity with IEC, UL, CSA, CCC EAC, and JIS standards, as well as CE marking and marine approvals

Up to IP66, 67, 69, 69K, and type 4X protection ratings

High vibration resistance with shake-proof terminal screws



Operating temperature from -40°C to 70°C

Shock protection level up to IK06

Secure switching of inductive or heavy DC loads directly – 100 000 operations at 10A, 24V dc

Offer Marketing Illustration

Product benefits / Features

Technical Benefits

Harmony XB5

Conformity with IEC, UL, CSA, CCC EAC, and JIS standards, as well as CE marking and marine approvals

Up to IP66, 67, 69, 69K, and type 4X protection ratings

High vibration resistance with shake-proof terminal screws



Operating temperature from -40°C to 70°C

Shock protection level up to IK06

Secure switching of inductive or heavy DC loads directly – 100 000 operations at 10A, 24V dc

Offer Marketing Illustration

Product benefits / Features



The infographic features a central image of a Schneider XB5 terminal block. Surrounding this central image are five circular icons, each with a corresponding text description of a product feature. The background is a solid green color.

Features Harmony XB5

- Quick and easy assembly and disassembly** (Icon: crossed wrench and screwdriver)
- Excellent mechanical connection with operator head** (Icon: hand holding a terminal)
- Various types of connection: screw clamp, connector, Faston connector, spring terminal, or printed circuit board** (Icon: screwdriver)
- Large set of accessories to customize your panels** (Icon: terminal block with a screwdriver)
- Robustness to withstand harsh environments** (Icon: lightning bolt and rain cloud)

Image of product / Alternate images

Alternative

