















10 710 970 Product version from 10/1/2024



- control for single basin
- including adapter for Bowden cable

Not compatible with brushed stainless steel kitchen sinks 38 XXX 004-86.

Fits ELIO, ENO, MEM, META SQUARE, SYNC, TARA and TARA ULTRA

	Brushed Dark Platinum	10 710 970-99
	Chrome	10 710 970-00
	Brushed Platinum	10 710 970-06
	Platinum	10 710 970-08
	Durabrand (23kt Gold)	10 710 970-09
	Dark Chrome	10 710 970-19
	Brushed Durabrand (23kt Gold)	10 710 970-28
	Matte Black	10 710 970-33
	Brushed Dark Brass (PVD)	10 710 970-39
	Brushed Bronze (PVD)	10 710 970-42
	Brushed Dark Bronze (PVD)	10 710 970-43
	Brushed Champagne (22kt Gold)	10 710 970-46
	Champagne (22kt Gold)	10 710 970-47
	Brushed Chrome	10 710 970-93

10 710 970 Product version from 10/1/2024

mm [inches]

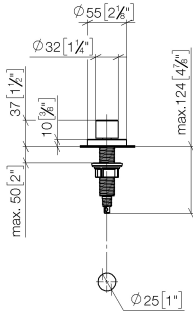

10 710 970 Product version from 10/1/2024

Parts for other finishes can be found here: [Chrome](#)

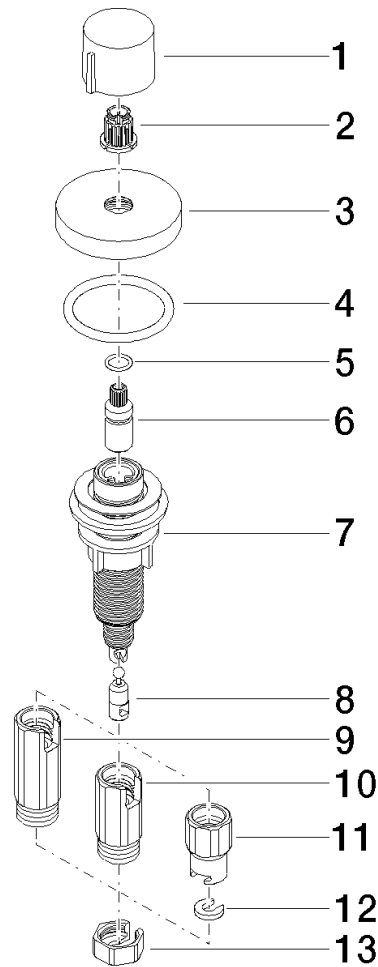

Spare parts list

No.	Item Number	Name	Quantity used	Delivery time
12	09 30 11 087 90	Disc 12,60 x 6,00 x 2,4 mm -	1.00	14
6	09 29 06 087-99	Connection Spindle extension Ø 12 x 31 mm - Brushed Dark Platinum	1.00	-
Spare part can no longer be ordered, please order the replacement item				
4	90 14 10 043 00 90	O-Ring 40,0 x 4,0 mm -	1.00	14
1	09 20 97 030-99	Handle Ø 31,5 x 25 mm - Brushed Dark Platinum	1.00	40
8	09 24 03 175 90	Connection for strainer waste -	1.00	14
9	09 11 10 073-07	Connection Ø 20 x 52,5 mm - untreated nickel-plated	1.00	40
13	09 23 30 024-07	Mounting for strainer waste set - untreated nickel-plated	1.00	40
7	04 30 01 029 00 90	Connection for strainer waste activation -	1.00	14
11	09 11 10 079-07	Connection Ø 20 x 32 mm - untreated nickel-plated	1.00	40
5	09 14 10 042 90	O-Ring EPDM 70 9,0 x 1,5 mm -	1.00	14
3	09 27 87 006-99	Rosette - Brushed Dark Platinum	1.00	40
2	90 12 12 002 00 90	Fixing cap white Ø 15 x 12 mm -	1.00	14
10	09 11 10 074-07	Connection Ø 20 x 42 mm - untreated nickel-plated	1.00	40