

Data Sheet | Item Number: 2050-316

2-conductor miniature through terminal block; with operating slots; 1 mm²; with snap-in mounting foot; side and center marking; with test port; Push-in CAGE CLAMP®; 1,00 mm²; yellow

<https://www.wago.com/2050-316>

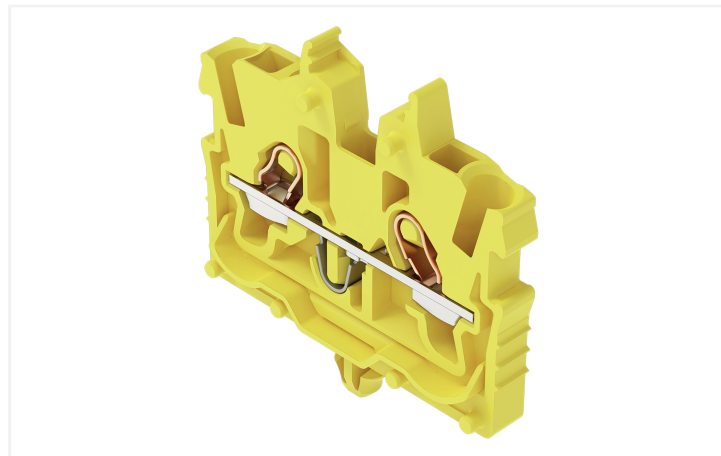
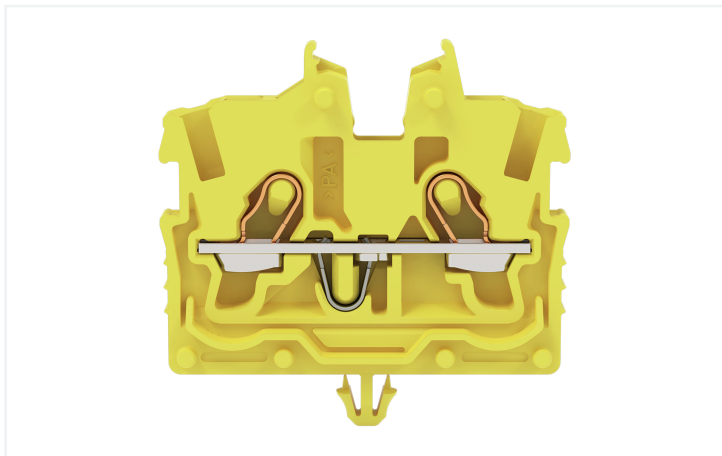

Color: ■ yellow

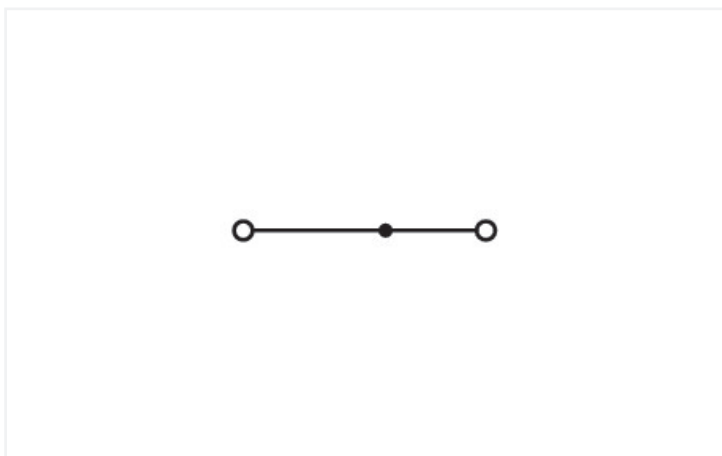

Similar to illustration

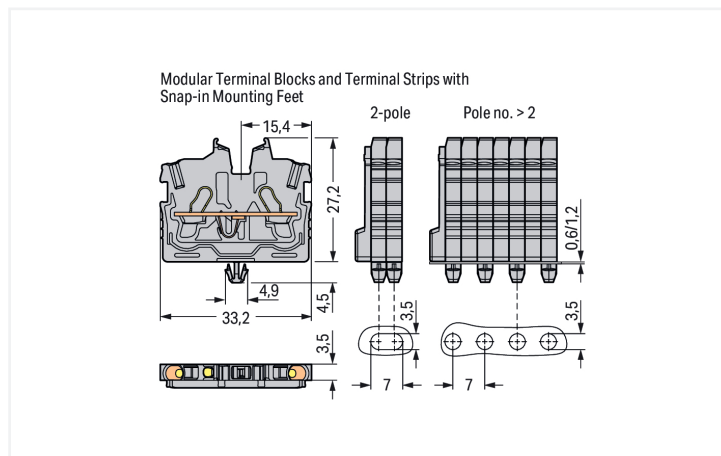

Through terminal block, 2050 Series, yellow

Connect conductors quickly and safely with this through terminal block (item number 2050-316). Strip lengths must be between 9 and 11 mm when connecting conductors to this through terminal block. Whether for use in industry or building installations, our rail-mount through terminal blocks allow you to quickly and securely connect electrical conductors. They're perfect for either classic through-wiring or distributing potential, depending on the variant. This product features conductor terminals and utilizes Push-in CAGE CLAMP®. Push-in CAGE CLAMP® connection technology is ideal for connecting all conductor types. Solid and fine-stranded conductors with ferrules can be plugged in without needing to use any tools—all thanks to its plug-gable design. Depending on the type of conductor, this through terminal block is suitable for conductor cross sections ranging from 0.14 mm² to 1.5 mm².

This mini rail-mount terminal block is operated with an operating tool. Our TOPJOB® S rail-mount terminal blocks guarantee reliable electrical connections in different industrial applications and modern building installations. They simplify wiring, as you can quickly plug in solid, stranded, and fine-stranded conductors with ferrules. This product is designed for specific Ex applications (please refer to the product datasheet).

Electrical data

Ratings per	IEC/EN 60998-2-2		
Overvoltage category	III	III	II
Pollution degree	3	2	2
Nominal voltage	500 V	-	-
Rated impulse withstand voltage	6 kV	-	-
Rated current	13.5 A	-	-
Current at conductor cross-section (max.) mm ²	17.5 A	-	-

Approvals per	UL 1059		
Use group	B	C	D
Rated voltage	300 V	300 V	-
Rated current	10 A	10 A	-

Approvals per	CSA 22.2 No 158		
Use group	B	C	D
Rated voltage	300 V	300 V	-
Rated current	10 A	10 A	-

Ex information	
Reference to hazardous areas	See "Downloads – Documentation – Additional Information: Technical Section; Technical Explanations"
Ratings per	ATEX: PTB 19 ATEX 1019 U / IECEx: PTB 19.0050U (Ex eb IIC Gb)
Rated voltage EN (Ex e II)	352 V
Rated current (Ex e II)	13.5 A
Rated current (Ex e II) with jumper	12 A

Power Loss	
Power loss, per pole (potential)	0.4338 W
Rated current I_N for power loss specification	13.5 A
Resistance value for specified, current-dependent power loss	0.00238 Ω

General information	
Wiring direction	Front-entry wiring

Connection Data

Clamping units	2
Total number of potentials	1
Number of levels	1
Number of jumper slots	1

Connection 1	
Connection technology	Push-in CAGE CLAMP®
Actuation type	Operating tool
Connectable conductor materials	Copper
Nominal cross-section	1 mm ²
Solid conductor	0.14 ... 1.5 mm ² / 24 ... 16 AWG
Solid conductor; push-in termination	0.5 ... 1.5 mm ² / 20 ... 16 AWG
Fine-stranded conductor	0.14 ... 1.5 mm ² / 24 ... 16 AWG
Fine-stranded conductor; with insulated ferrule	0.14 ... 1 mm ² / 24 ... 18 AWG
Fine-stranded conductor; with uninsulated ferrule	0.14 ... 1 mm ² / 24 ... 18 AWG
Fine-stranded conductor; with ferrule; push-in termination	0.5 ... 1 mm ² / 20 ... 18 AWG
Note (conductor cross-section)	Depending on the conductor characteristic, a conductor with a smaller cross-section can also be inserted via push-in termination.
Strip length	9 ... 11 mm / 0.35 ... 0.43 inches
Wiring direction	Front-entry wiring

Physical data

Width	3.5 mm / 0.138 inches
Height from the surface	27.2 mm / 1.071 inches
Depth	33.2 mm / 1.307 inches

Mechanical data

Mounting type	Snap-in foot
Marking level	Center/side marking

Material data

Note (material data)	Information on material specifications can be found here
Color	yellow
Material group	I
Insulation material (main housing)	Polyamide (PA66)
Flammability class per UL94	V0
Fire load	0.047 MJ
Weight	2.4 g

Environmental requirements

Processing temperature	-35 ... +85 °C
Continuous operating temperature	-60 ... +105 °C

Commercial data

PU (SPU)	100 pcs
Packaging type	Box
Country of origin	IN
GTIN	4066966312720
Customs tariff number	85369010000

Product Classification

UNSPSC	39121410
ETIM 9.0	EC001284
ETIM 10.0	EC001284
ECCN	NO US CLASSIFICATION

Environmental Product Compliance

RoHS Compliance Status	Compliant, No Exemption
------------------------	-------------------------

Approvals / Certificates

Approvals for marine applications



Approval	Standard	Certificate Name
DNV DNV GL SE	-	TAE00003JT

Approvals for hazardous areas



Approval	Standard	Certificate Name
ATEX Physikalisch Technische Bundesanstalt	EN 60079	PTB 19 ATEX 1019 U
IECEx Physikalisch Technische Bundesanstalt	IEC 60079	IECEx PTB 19.0050U

Approvals for hazardous areas

INMETRO IEC 60079 TÜV 22.0014 U
TÜV Rheinland do Brasil
Ltda.

Downloads

Environmental Product Compliance

Compliance Search

Environmental Product Compliance 2050-316

CAD/CAE-Data

CAD data

2D/3D Models 2050-316

1 Compatible Products

1.1 System counterpart

1.1.1 Through terminal block



Item No.: 2050-321
2-conductor miniature through terminal block; with operating slots; 1 mm²; Center terminal block without snap-in mounting foot, without mounting flange; side and center marking; with test port; Push-in CA-GE CLAMP®; 1,00 mm²; gray

1.2 Required Accessories

1.2.1 End plate

1.2.1.1 End plate



Item No.: 2050-391
End plate; for terminal blocks with snap-in mounting foot; 3.4 mm thick; gray

1.3 Optional Accessories

1.3.1 DIN-rail

1.3.1.1 Mounting accessories



Item No.: 210-154

Aluminum carrier rail; 1000 mm long; 18 mm wide; 7 mm high; silver-colored

1.3.2 Ferrule

1.3.2.1 Ferrule



Item No.: 216-241

Ferrule; Sleeve for 0.5 mm² / 20 AWG; insulated; electro-tin plated; electrolytic copper; gastight crimped; acc. to DIN 46228, Part 4/09.90; white



Item No.: 216-242

Ferrule; Sleeve for 0.75 mm² / 18 AWG; insulated; electro-tin plated; electrolytic copper; gastight crimped; acc. to DIN 46228, Part 4/09.90; gray



Item No.: 216-243

Ferrule; Sleeve for 1 mm² / AWG 18; insulated; electro-tin plated; electrolytic copper; gastight crimped; acc. to DIN 46228, Part 4/09.90; red

1.3.3 Installation

1.3.3.1 Mounting accessories



Item No.: 209-137

Mounting adapter; can be used as end stop; 6.5 mm wide; gray



Item No.: 209-120

Mounting foot; can be snapped on terminal blocks with snap-in mounting foot; for mounting on relay-modules; 6.4 mm wide; gray

1.3.4 Jumper

1.3.4.1 Jumper



Item No.: 2000-406/020-000

Delta jumper; insulated; light gray



Item No.: 2000-410/000-006

Jumper; 10-way; insulated; blue



Item No.: 2000-410

Jumper; 10-way; insulated; light gray



Item No.: 2000-410/000-005

Jumper; 10-way; insulated; red



Item No.: 2000-402/000-006

Jumper; 2-way; insulated; blue



Item No.: 2000-402

Jumper; 2-way; insulated; light gray



Item No.: 2000-402/000-005

Jumper; 2-way; insulated; red



Item No.: 2000-402/000-018

Jumper; 2-way; insulated; yellow-green



Item No.: 2000-403/000-006

Jumper; 3-way; insulated; blue



Item No.: 2000-403

Jumper; 3-way; insulated; light gray



Item No.: 2000-403/000-005

Jumper; 3-way; insulated; red



Item No.: 2000-404/000-006

Jumper; 4-way; insulated; blue



Item No.: 2000-404

Jumper; 4-way; insulated; light gray



Item No.: 2000-404/000-005

Jumper; 4-way; insulated; red



Item No.: 2000-405/000-006

Jumper; 5-way; insulated; blue



Item No.: 2000-405

Jumper; 5-way; insulated; light gray



Item No.: 2000-405/000-005

Jumper; 5-way; insulated; red



Item No.: 2000-406/000-006

Jumper; 6-way; insulated; blue



Item No.: 2000-406

Jumper; 6-way; insulated; light gray



Item No.: 2000-406/000-005

Jumper; 6-way; insulated; red

1.3.4.1 Jumper











 Item No.: 2000-407/000-006 Jumper; 7-way; insulated; blue	 Item No.: 2000-407 Jumper; 7-way; insulated; light gray	 Item No.: 2000-407/000-005 Jumper; 7-way; insulated; red	 Item No.: 2000-408/000-006 Jumper; 8-way; insulated; blue
 Item No.: 2000-408 Jumper; 8-way; insulated; light gray	 Item No.: 2000-408/000-005 Jumper; 8-way; insulated; red	 Item No.: 2000-409/000-006 Jumper; 9-way; insulated; blue	 Item No.: 2000-409 Jumper; 9-way; insulated; light gray
 Item No.: 2000-409/000-005 Jumper; 9-way; insulated; red	 Item No.: 2000-440 Jumper; from 1 to 10; insulated; light gray	 Item No.: 2000-433/000-006 Jumper; from 1 to 3; insulated; blue	 Item No.: 2000-433 Jumper; from 1 to 3; insulated; light gray
 Item No.: 2000-433/000-005 Jumper; from 1 to 3; insulated; red	 Item No.: 2000-434 Jumper; from 1 to 4; insulated; light gray	 Item No.: 2000-435 Jumper; from 1 to 5; insulated; light gray	 Item No.: 2000-436 Jumper; from 1 to 6; insulated; light gray
 Item No.: 2000-437 Jumper; from 1 to 7; insulated; light gray	 Item No.: 2000-438 Jumper; from 1 to 8; insulated; light gray	 Item No.: 2000-439 Jumper; from 1 to 9; insulated; light gray	 Item No.: 2000-405/011-000 Star point jumper; 3-way; insulated; light gray

1.3.5 Marking

1.3.5.1 Group marker carrier

 Item No.: 2009-191 Group marker carrier; gray
--

1.3.5.2 Marker

 Item No.: 793-3501 WMB marking card; as card; plain; snap-on type; white	 Item No.: 2009-113/000-006 WMB-Inline; for Smart Printer; 2300 pieces on roll; plain; snap-on type; blue	 Item No.: 2009-113/000-007 WMB-Inline; for Smart Printer; 2300 pieces on roll; plain; snap-on type; gray	 Item No.: 2009-113/000-023 WMB-Inline; for Smart Printer; 2300 pieces on roll; plain; snap-on type; green
 Item No.: 2009-113/000-017 WMB-Inline; for Smart Printer; 2300 pieces on roll; plain; snap-on type; light green	 Item No.: 2009-113/000-012 WMB-Inline; for Smart Printer; 2300 pieces on roll; plain; snap-on type; orange	 Item No.: 2009-113/000-005 WMB-Inline; for Smart Printer; 2300 pieces on roll; plain; snap-on type; red	 Item No.: 2009-113/000-024 WMB-Inline; for Smart Printer; 2300 pieces on roll; plain; snap-on type; violet
 Item No.: 2009-113 WMB-Inline; for Smart Printer; 2300 pieces on roll; plain; snap-on type; white	 Item No.: 2009-113/000-002 WMB-Inline; for Smart Printer; 2300 pieces on roll; plain; snap-on type; yellow		

1.3.5.3 Marking strip

 Item No.: 2009-110 Marking strips; for Smart Printer; on reel; not stretchable; plain; snap-on type; white

1.3.6 Protective warning marker

1.3.6.1 Cover



Item No.: 2000-115

Protective warning marker; for 5 terminal blocks; with high-voltage symbol, black; yellow

1.3.7 Push-in type wire jumper

1.3.7.1 Jumper



Item No.: 2009-404

Push-in type wire jumper; 0.75 mm²; insulated; 110 mm long; gray



Item No.: 2009-406

Push-in type wire jumper; 0.75 mm²; insulated; 250 mm long; gray



Item No.: 2009-402

Push-in type wire jumper; 0.75 mm²; insulated; 60 mm long; gray

1.3.8 Test and measurement

1.3.8.1 Testing accessories



Item No.: 2009-174

Test plug adapter; for 4 mm Ø test plugs; for testing TOPJOB®S rail-mounted terminal blocks; gray



Item No.: 210-136

Test plug; 2 mm Ø; with 500 mm cable; red



Item No.: 2009-182

Testing tap; for max. 2.5 mm²; tool-free connection for individual test wires 0.08 - 2.5 mm; gray

1.3.9 Tool

1.3.9.1 Operating tool



Item No.: 210-719

Operating tool; Blade: 2.5 x 0.4 mm; with a partially insulated shaft



Item No.: 210-648

Operating tool; Blade: 2.5 x 0.4 mm; with a partially insulated shaft; angled; short



Item No.: 210-647

Operating tool; Blade: 2.5 x 0.4 mm; with a partially insulated shaft; multicoloured

Installation Notes

Installation

Example of a 5-pole terminal strip; with operating slots; with snap-in mounting feet
Pole number = 2

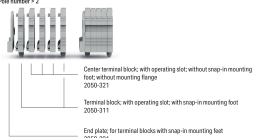

Example of a 2-pole terminal strip; with operating slots; with snap-in mounting feet

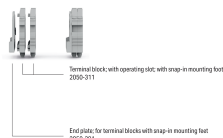

Conductor termination



Insert solid conductors via push-in termination.



Insert ferruled conductors via push-in termination.

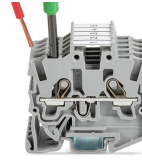

Insert fine-stranded conductors via operating tool.

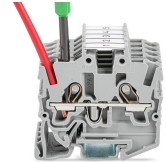

Remove all conductors via operating tool.

Commoning

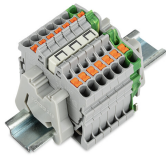

Insert a delta jumper and push down until it hits the backstop (example shows terminal blocks with push-buttons).

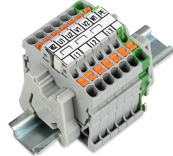

Marking strip (Item No. 2009-110) inserted in the marking slot with jumper symbols of the inserted jumper (delta jumper) (example shows terminal blocks with push-buttons)



Insert a star point jumper and push down until it hits the backstop (example shows terminal blocks with push-buttons).

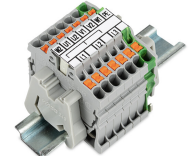

Marking strip (Item No. 2009-110) inserted in the marking slot with jumper symbols of the inserted jumper (2000-405/011-000 Delta Jumper) (example shows terminal blocks with push-buttons)

Testing



Testing with a 2 mm Ø 210-136 Test Plug (max. 42 V).

Installation



Mounting a terminal strip with snap-in feet into holes.



Mounting a terminal strip with snap-in feet onto aluminum rail.

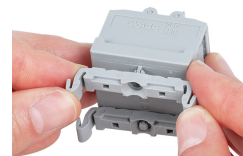

Snapping a mounting foot (209-120) to a terminal strip with snap-in mounting feet. (Distance between mounting feet: approx. 20 ... 25 mm)

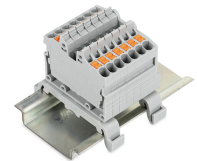

Terminal strip; with snap-in mounting feet; for DIN-35 rail (209-120 Mounting Foot) (example shows terminal blocks with push-buttons)

Marking



Snapping a marking strip into the marker slot.



Snapping a marking strip (Item No. 2009-110) into a marker slot.