

Productinformatieblad

Specificaties

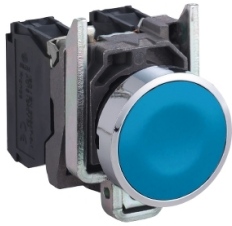

Drukknop, Verzonken, Terugvering, Ø22mm, 1NO, Ongemarkeerd, Blauw

XB4BA61

EAN Code: 3389110118438

Prijs: 15,35 EUR

Hoofd

range of product	Harmony XB4
device short name	XB4
product of component type	Drukknop
kraag materiaal	Verchroomd metaal
materiaal bevestigingskraag	Zamak
bevestigingsdiameter	22,5 mm
verkoop per ondeelbare hoeveelheid	1
vorm van kop signaleringseenheid	Rond
type operator	terugverend
operator profiel	Blauw verzonken, niet gemarkeerd
koptype	Standaard
type en samenstelling contacten	1 NO
werking contacten	Slow-break
aansluitingen - aansluitklemmen	Schroefklem aansluitingen, $\leq 2 \times 1,5 \text{ mm}^2$ met kabeluiteinde In overeenstemming met IEC 60947-1 Schroefklem aansluitingen, $1 \times 0,22...2 \times 2,5 \text{ mm}^2$ zonder kabeluiteinde In overeenstemming met IEC 60947-1

Complementair

hoogte	47 mm
breedte	30 mm
diepte	52 mm
beschrijving klemmen ISO n°1	(13-14)NO
gewicht product	0,08 kg
weerstand hoge druk drukring	7000000 Pa om 55 °C, afstand: 0.1 m
contact gebruik	Standaardcontacten
positieve opening	Zonder
bedrijfstraject	2,6 mm (normaal open elektrische status wijzigen) 4,3 mm (totale reis)
bedieningskracht	3,8 N normaal open elektrische status wijzigen
mechanical durability	10000000 cycles
aanspanmoment	0,8...1,2 N.m In overeenstemming met IEC 60947-1

De weergegeven prijs is de adviesprijs in euro excl. BTW. Deze kan onderhevig zijn aan korting. Neem contact op met uw lokale distributeur of detailhandel voor de daadwerkelijke prijs

vorm schroefkop	Kruis compatibel met kruis nr. 1 schroevendraaier Kruis compatibel met pozidriv Nr. 1 schroevendraaier Gegroefd compatibel met vlak Ø 4 mm schroevendraaier Gegroefd compatibel met vlak Ø 5,5 mm schroevendraaier
contact materiaal	Zilverlegering (Ag/Ni)
kortsluitbeveiliging	10 A smeltpatroon type gG In overeenstemming met IEC 60947-5-1
Ith conventionele thermische stroom in vrije lucht	10 A In overeenstemming met IEC 60947-5-1
Ui nom. isolatiespanning	600 V (vervuilingsgraad 3) In overeenstemming met IEC 60947-1
Uimp nom. schokgolfspanning	6 kV In overeenstemming met IEC 60947-1
Ie nom. bedrijfstrom	3 A om 240 V, AC-15, A600 In overeenstemming met IEC 60947-5-1 6 A om 120 V, AC-15, A600 In overeenstemming met IEC 60947-5-1 0,1 A om 600 V, DC-13, Q600 In overeenstemming met IEC 60947-5-1 0,27 A om 250 V, DC-13, Q600 In overeenstemming met IEC 60947-5-1 0,55 A om 125 V, DC-13, Q600 In overeenstemming met IEC 60947-5-1 1,2 A om 600 V, AC-15, A600 In overeenstemming met IEC 60947-5-1
elektrische levensduur	1000000 cycles, AC-15, 2 A om 230 V, gebruiksnelheid <3600 cyc/h, belastingsfactor: 0,5 In overeenstemming met IEC 60947-5-1 appendix C 1000000 cycles, AC-15, 3 A om 120 V, gebruiksnelheid <3600 cyc/h, belastingsfactor: 0,5 In overeenstemming met IEC 60947-5-1 appendix C 1000000 cycles, AC-15, 4 A om 24 V, gebruiksnelheid <3600 cyc/h, belastingsfactor: 0,5 In overeenstemming met IEC 60947-5-1 appendix C 1000000 cycles, DC-13, 0,2 A om 110 V, gebruiksnelheid <3600 cyc/h, belastingsfactor: 0,5 In overeenstemming met IEC 60947-5-1 appendix C 1000000 cycles, DC-13, 0,5 A om 24 V, gebruiksnelheid <3600 cyc/h, belastingsfactor: 0,5 In overeenstemming met IEC 60947-5-1 appendix C
elektrische betrouwbaarheid	$\Lambda < 10^{\exp(-6)}$ om 5 V en 1 mA in propere omgeving In overeenstemming met IEC 60947-5-4 $\Lambda < 10^{\exp(-8)}$ om 17 V en 5 mA in propere omgeving In overeenstemming met IEC 60947-5-4
product presentatie	Compleet product

Omgeving

beschermende behandeling	TH
ambient air temperature for storage	-40...70 °C
omgevingstemperatuur voor werking	-40...70 °C
overvoltage category	Klasse I In overeenstemming met IEC 60536
IP beschermingsgraad	IP66 In overeenstemming met IEC 60529 IP67 IP69 IP69K
Enclosure Type	UL type 4X/13
IK-beschermingsgraad	IK06 In overeenstemming met IEC 50102
standards	JIS C8201-5-1 IEC 60947-5-1 IEC 60947-1 UL 508 IEC 60947-5-4 IEC 60947-5-5 CSA C22.2 Nr 14 JIS C8201-1
product certifications	CSA LROS (Lloyds register of shipping) BV UL listed DNV
trilling bestendigheid	5 gn (f= 2...500 Hz) In overeenstemming met IEC 60068-2-6

schokbestendigheid	30 gn (duur = 18 ms) voor halve sinusgolf versnelling In overeenstemming met IEC 60068-2-27 50 gn (duur = 11 ms) voor halve sinusgolf versnelling In overeenstemming met IEC 60068-2-27
---------------------------	--

Verpakkingseenheid

Eenheidstype van verpakking 1	PCE
--------------------------------------	-----

Aantal eenheden in verpakking 1	1
--	---

verpakking 1 hoogte	8,800 cm
----------------------------	----------

verpakking 1 breedte	3,400 cm
-----------------------------	----------

verpakking 1 lengte	5,400 cm
----------------------------	----------

verpakking_1_gewicht	79,000 g
-----------------------------	----------

Eenheidstype van verpakking 2	S03
--------------------------------------	-----

Aantal eenheden in verpakking 2	150
--	-----

verpakking 2 hoogte	30,000 cm
----------------------------	-----------

verpakking 2 breedte	30,000 cm
-----------------------------	-----------

verpakking 2 lengte	40,000 cm
----------------------------	-----------

verpakking 2 gewicht	12,480 kg
-----------------------------	-----------

Eenheidstype van verpakking 3	P06
--------------------------------------	-----

Aantal eenheden in verpakking 3	1200
--	------

verpakking_3_hoogte	75,000 cm
----------------------------	-----------

verpakking 3 breedte	60,000 cm
-----------------------------	-----------

verpakking 3 lengte	80,000 cm
----------------------------	-----------

verpakking 3 gewicht	108,340 kg
-----------------------------	------------

contractuele waarborg

Garantie (in maanden)	18
------------------------------	----

Schneider Electric wil tegen 2050 de Net Zero-status hebben bereikt via partnerschappen in de toeleveringsketen, materialen met een lagere impact en circulariteit via onze doorlopende campagne "Use Better, Use Longer, Use Again" om de levensduur van producten en de recycleerbaarheid te verlengen.

[Uitleg van Environmental Data >](#)

[Hoe evalueren we de duurzaamheid van producten? >](#)

Milieuoetafdruk

Totale levenscyclus ecologische voetafdruk	0.7 kg CO2 eq.
Koolstofvoetafdruk van de fabricagefase [A1–A3]	0.6 kg CO2 eq.
Koolstofvoetafdruk van de distributiefase [A4]	0 kg CO2 eq.
Koolstofvoetafdruk van de installatiefase [A5]	0 kg CO2 eq.
Koolstofvoetafdruk van de gebruiksfase [B2, B3, B4, B6]	0 kg CO2 eq.
Koolstofvoetafdruk van de einde-levensfase [C1–C4]	0.1 kg CO2 eq.

Use Better

Materialen en verpakking

Gemiddeld percentage gerecycleerde kunststof	19 %
Gemiddeld percentage gerecycleerd metaal	18 %
Pakket met gerecycleerd karton	Ja
Verpakkingen zonder kunststof	Ja
RoHS-richtlijn van de EU	Conform
REACH-verordening	Referentie bevat zorgwekkende stoffen (SVHC) boven drempelwaarde

Use Longer

Levensduurverlenging

Reparatie	Nee
Productreparatie-index	A

Use Again

Herverpakken en herfabriceren

Circulair Profiel	Informatie over einde levensduur
Terugname	Ja
WEEE-label	 Het product moet op markten van de Europese Unie worden afgevoerd volgens specifieke afvalinzamelingsregels en mag nooit in een gewone vuilnisbak terechtkomen.

Dimensions Drawings

Dimensions

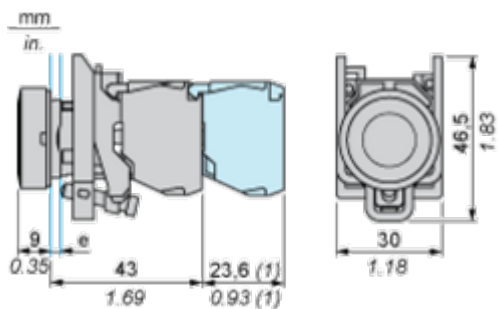

e : clamping thickness: 1 to 6 mm / 0.04 to 0.24 in.

(1) Additional row of contacts or double contact.

Mounting and Clearance

Panel Cut-out for Pushbuttons, Switches and Pilot Lights (Finished Holes, Ready for Installation)

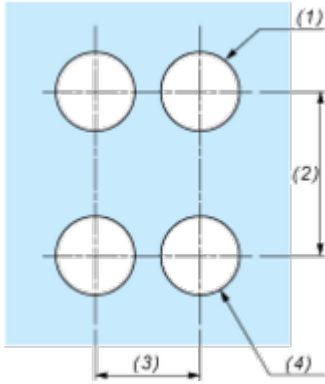
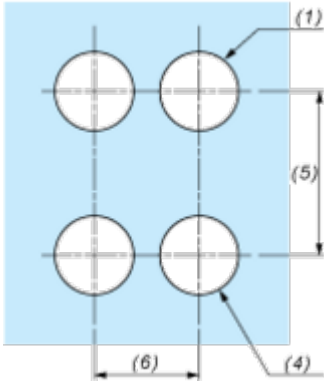
Connection by Screw Clamp Terminals or Plug-in Connectors or on Printed Circuit Board	Connection by Faston Connectors
	
<p>(1) Diameter on finished panel or support (2) 40 mm min. / 1.57 in. min. (3) 30 mm min. / 1.18 in. min. (4) $\varnothing 22.5 \text{ mm} / 0.89 \text{ in.}$ recommended ($\varnothing 22.3 \text{ mm}_0^{+0.4} / 0.88 \text{ in.}_0^{+0.016}$) (5) 45 mm min. / 1.78 in. min. (6) 32 mm min. / 1.26 in. min.</p>	

Technical Illustration

Dimensions

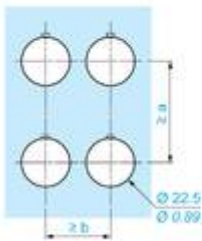
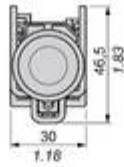
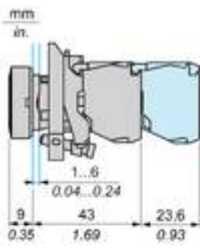

		a (mm)	a (in.)	b (mm)	b (in.)
		40	1.57	30	1.18
ZBE.....	ZBV.....				
		45	1.77	32	1.26
ZBE.....3	ZBV.....3				
		40	1.57	30	1.18
ZBE.....4	ZBV.....4				
		50	1.97	30	1.18
ZBE.....5	ZBV.....5				
		40	1.57	30	1.18
ZBE.....9	ZBV.....9				
		40	1.57	30	1.18
ZBR1	ZBRV1				



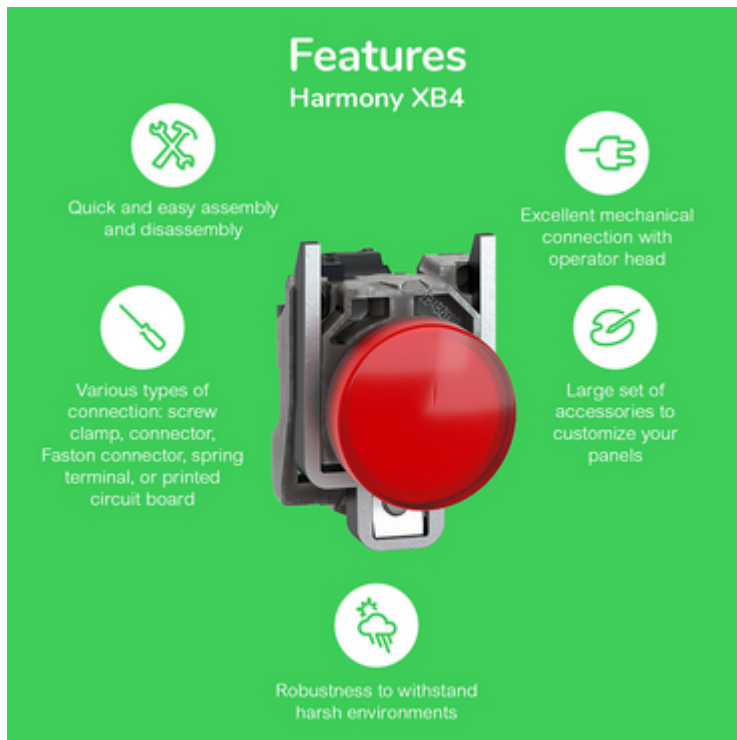

Offer Marketing Illustration

Product benefits / Features



The infographic features a central image of a red Schneider XB4 terminal block. Surrounding it are five circular icons, each with a corresponding text description of a feature. The background is a solid green color.

Features Harmony XB4

-  Quick and easy assembly and disassembly
-  Various types of connection: screw clamp, connector, Faston connector, spring terminal, or printed circuit board
-  Excellent mechanical connection with operator head
-  Large set of accessories to customize your panels
-  Robustness to withstand harsh environments

Offer Marketing Illustration

Product benefits / Features

Technical Benefits

Harmony XB4



Image of product / Alternate images

Alternative

