

Installation avec conduites composites eau potable / chauffage / refroidissement

uponor

Liste des articles Benelux 01-2023

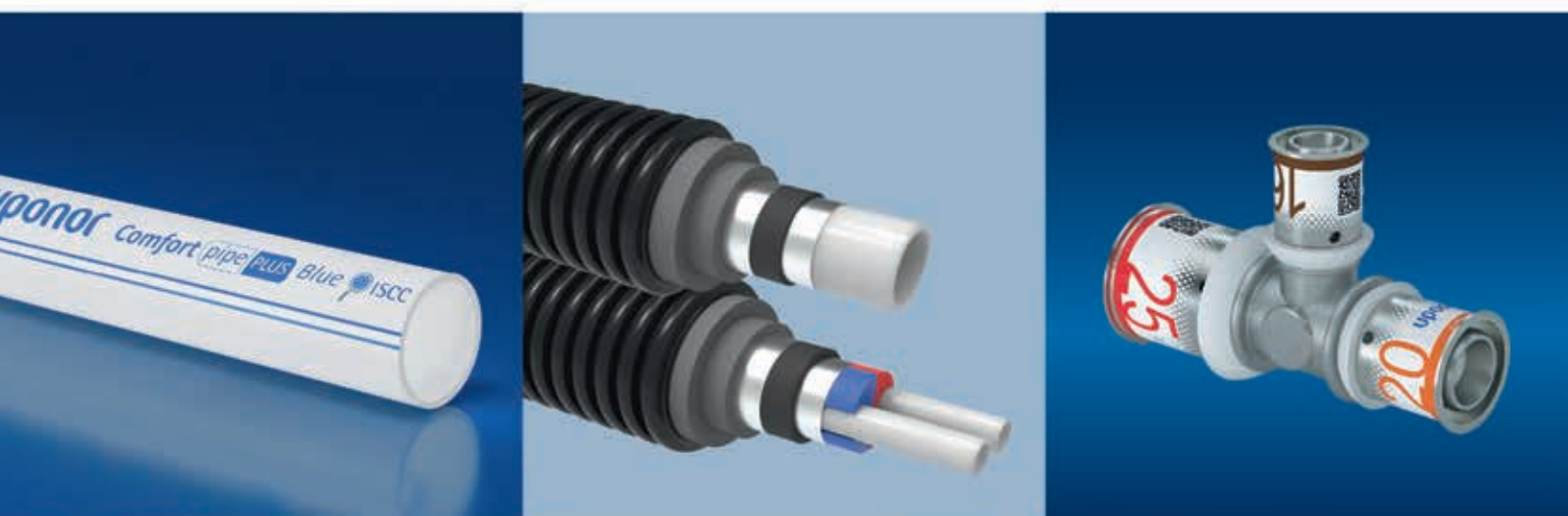

Uponor Liste des articles condensée 2023

Installation

Installation avec conduites composites

<i>Vue d'ensemble Uponor conduites de raccordement et techniques de raccordement</i>	5
Uponor MLC - conduites composites	6
Raccords	
Uponor S-Press PLUS PPSU	8
Uponor S-Press PLUS 14 mm	9
Uponor S-Press PLUS 16-75 mm	10
Uponor RS 63-110 mm	19
Uponor RTM 16-25 mm	20

Chauffage de surface, refroidissement de surface

Installation dans le sol pour nouvelle construction et travaux de rénovation

<i>Systèmes Uponor pour chauffer et refroidir</i>	22
<i>Conduites pour le chauffage/refroidissement de surface</i>	24

Systèmes Uponor pour chauffer et refroidir

Uponor 10 bar UFH Chauffage au sol	26
Uponor Minitec	27
Uponor Tecto	28
Uponor Nubos	30
Uponor Klett	31
Uponor Tacker	32
Uponor Fix	34
Uponor Classic	35
Uponor Comfort E	36
Uponor Siccus 14	37
Uponor Renovis	38
Uponor Siccus wall	40
Uponor Siccus SW	40
Uponor Thermatop	41
Uponor Multi	42
Conduites de distribution 25–75 mm	43

Techniques de collecteurs Uponor

<i>Vue d'ensemble des actionneurs</i>	44
Uponor Vario PLUS	45
Uponor Vario M	46
Uponor Vario S	47
<i>Cotes de montage armoires de distribution</i>	48

Régulations de la température de locaux individuels pour habitations

<i>individuels pour habitations</i>	50
<i>Eventail des fonctions Smatrix Wave/Base</i>	51
Uponor Smatrix Wave / Pulse	52
Uponor Smatrix Base / Pulse	54
Uponor Smatrix Base PRO	56
Uponor Base	56
Uponor Vario	57

Régulation Uponor de la température de départ /

Groupes de pompes

Uponor Smatrix Move PRO	58
Uponor Smatrix Move	58
Uponor Fluvia	59

Réseau terrestre – distribution

Système de distribution de chaleur et de froid Uponor Ecoflex

Uponor Ecoflex VIP Thermo	64
Uponor Ecoflex Thermo	64
Uponor Ecoflex VIP Aqua	65
Uponor Ecoflex Aqua	65
Uponor Ecoflex Quattro	65
Uponor Ecoflex Supra	66
Uponor Ecoflex Supra PLUS	67
Techniques de connexion	
Uponor Wipex	68
Uponor Q&E	70
Uponor Ecoflex Accessoires	71

Outillages

Uponor Dérouleur	73
Uponor outillages de coupe et de préparation	74
Uponor outillages pour pose chauffage sol	75
Uponor divers	76

Annexe

Télécharger la liste de prix en ligne complète :	79
--	----

Installation avec conduites composites

Installation eau potable / chauffage / refroidissement /
avec conduites composites Uponor



Installation

Chauffage de surface, refroidissement de surface

Installation dans le sol pour nouvelle construction et travaux de rénovation
Techniques de collecteurs Uponor
Régulation de la température ambiante
Régulation Uponor de la température de départ / Groupes de pompes



Chauffage surface

Reseau terrestre - distribution

Système de distribution de chaleur
et de froid Uponor Ecoflex

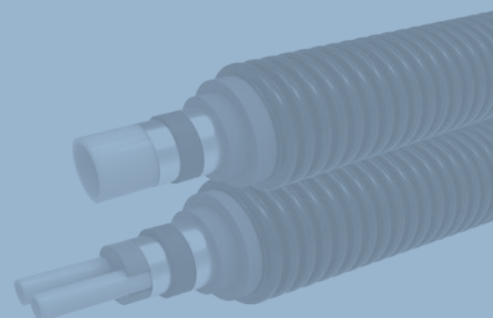

Distribution

Outillages Uponor

Dériveurs, outillages de coupe et de préparation,
outillages d'expansion, de pose de chauffage sol et divers



Outillages Uponor

Annexe











Annexe

Vue d'ensemble Uponor conduites de raccordement

Différentes situations de montage et domaines d'application exigent des conceptions d'assemblage parfaitement adaptés. Pour cette raison, Uponor développe des produits, non seulement des conduites, mais aussi des systèmes de raccordement parfaitement adaptés à l'application prévue. La gamme de raccordement Uponor comprenant des raccords, des coudes, des raccords en T ainsi qu'un grand nombre de composants de système permettons un montage rapide, sûr et pratique, tout en dépassant les exigences imposées à une installation d'eau potable hygiénique et à une tuyauterie d'eau chaude contemporaine.

Uponor système de raccordement

Dimension/ Code couleur	Conduite du type composite
-------------------------------	-------------------------------

 14	MLC
 16	Uni Pipe PLUS
 20	Uni Pipe PLUS
 25	Uni Pipe PLUS
 32	Uni Pipe PLUS
 40	MLC
 50	MLC
 63	MLC
 75	MLC
 90	MLC
 110	MLC

Caractéristiques

Code couleur en fonction des dimensions

Regard pour contrôler la profondeur d'insertion

Marquage de sertissage
par détachement de la feuille du raccord

Marquage de sertissage
par détachement de la bague de butée

Marquage de sertissage
par impression sur les mâchoires à sertir

Montage sans ébavurage

Montage sans étalonnage

Raccord non serti, non étanche

Fonction de sertissage intégrée

Système de raccordement modulaire

Uponor Uni Pipe PLUS

N° art.	Dimension	UL	UE	unité
---------	-----------	----	----	-------

Uponor Uni Pipe PLUS tube nu en barre S

 1060783	16x2,0 3m	75	3	m
1059572	16x2,0 5m	125	5	m
1060784	20x2,25 3m	51	3	m
1059573	20x2,25 5m	85	5	m
1060785	25x2,5 3m	30	3	m
1059574	25x2,5 5m	50	5	m
1060786	32x3,0 3m	21	3	m
1059575	32x3,0 5m	35	5	m

Uponor MLC tube, blanc S

 1013448	40x4,0 3m	12	3	m
1088465	40x4,0 3,3m	13,2	3,3	m
1013446	40x4,0 5m	20	5	m
1021980	50x4,5 3m	12	3	m
1013449	50x4,5 5m	20	5	m
1021981	63x6,0 3m	9	3	m
1013451	63x6,0 5m	15	5	m
1013453	75x7,5 5m	255	5	m
1013455	90x8,5 5m	255	5	m
1013457	110x10,0 5m	165	5	m

Uponor Uni Pipe PLUS blanc

 1091638	16x2,0 10m	880	220	m
1091639	16x2,0 25m	1600	400	m
1059576	16x2,0 100m	2000	100	m
1092653	16x2,0 120m	2400	120	m
1059577	16x2,0 200m	2600	200	m
1059578	16x2,0 500m	3500	500	m
1092671	20x2,25 25m	900	225	m
1059579	20x2,25 100m	1300	100	m
1093124	20x2,25 500m	2000	500	m
1059581	25x2,5 50m	700	50	m
1059583	32x3,0 50m	400	50	m

Uponor MLC tube, blanc

 1013366	14x2,0 200m	2600	200	m
--	-------------	------	-----	---

N° art.	Dimension	UL	UE	unité
---------	-----------	----	----	-------

Uponor Uni Pipe PLUS isolé, blanc S4 WLS 040

 1091709	16x2,0 red	800	100	m
1063553	16x2,0 blue	800	100	m
1091710	20x2,25 red	800	100	m
1063555	20x2,25 blue	800	100	m
1091711	25x2,5 red	400	50	m
1063946	25x2,5 blue	400	50	m
1091712	32x3,0 red	350	50	m
1091716	32x3,0 blue	350	50	m

Uponor MLC tube isolé blanc S6

 1013577	14x2,0 red	600	50	m
--	------------	-----	----	---

Uponor Uni Pipe PLUS isolé, blanc S6 WLS 035

 1063556	16x2,0 blue	600	75	m
1063557	20x2,25 blue	600	75	m
1063558	25x2,5 blue	400	50	m

Uponor Uni Pipe PLUS isolé, blanc S6 WLS 040

 1091713	16x2,0 red	600	75	m
1091714	20x2,25 red	600	75	m
1091715	25x2,5 red	400	50	m
1091723	16x2,0 blue	600	75	m
1091724	20x2,25 blue	600	75	m
1091725	25x2,5 blue	400	50	m

Uponor Uni Pipe PLUS tube pré-isolé en couronne S10 WLS 035

 1062181	16x2,0 blue	450	75	m
1062182	20x2,25 blue	525	75	m
1062183	25x2,5 blue	350	50	m

Uponor Uni Pipe PLUS isolé, blanc DHS26

 1063562	20x2,25 blue	200	25	m
--	--------------	-----	----	---

Uponor Uni Pipe PLUS

N° art.	Dimension	UL	UE	unité
---------	-----------	----	----	-------

Uponor Uni Pipe PLUS pré gainé

 1063061	16x2,0 - 25/20 red	1350	75	m
1063059	16x2,0 - 25/20 blue	1350	75	m
1063062	20x2,25 - 28/23 red	900	75	m
1063060	20x2,25 - 28/23 blue	900	75	m
1093128	25x2,5 - 40/32 red	450	50	m
1093129	25x2,5 - 40/32 blue	450	50	m

Uponor Uni Pipe PLUS pré gainé blanc twin

 1091718	16x2,0 - 25/20 black	650	50	m
--	----------------------	-----	----	---

Uponor MLC tube blanc pré gainé

 1013678	14x2,0 - 25/20 red	1500	75	m
--	--------------------	------	----	---

N° art.	Dimension	UL	UE	unité
---------	-----------	----	----	-------

Uponor Teck gaine

 1012860	25/20	2500	50	m
1012864	28/23	2000	50	m
1012869	35/29	1400	50	m
1012872	43/36	600	25	m



Uponor Teck fourreau de protection pour Tube

 1012859	25/20	2500	50	m
1012863	28/23	2000	50	m
1012867	35/29	1400	50	m



Uponor Teck fourreau de protection pour Tube

 1012858	25/20	2500	50	m
1012862	28/23	2000	50	m
1012866	35/29	1400	50	m

Uponor Teck cavaliers simples

  1135511	32	1600	200	pièce
 1135512	32	1600	200	pièce

Uponor Teck cavaliers doubles

  1135513	32	1200	200	pièce
 1135514	32	800	200	pièce

Uponor S-Press PLUS PPSU

N° art.	Dimension	UL	UE	unité
---------	-----------	----	----	-------

Uponor S-Press PLUS coude à sertir PPSU

 1039929	16-16	80	20	pièce
1039930	20-20	80	10	pièce
1039931	25-25	80	10	pièce
1039932	32-32	20	5	pièce

Uponor S-Press coude PPSU

 1046386	40-40	960	5	pièce
1046387	50-50	576	3	pièce
1032877	63-63	210	1	pièce
1032878	75-75	210	1	pièce

Uponor S-Press coude 45° PPSU

 1046388	40-40	960	5	pièce
1046389	50-50	576	3	pièce
1032879	63-63	192	1	pièce
1032880	75-75	192	1	pièce

Uponor S-Press PLUS manchon PPSU

 1039933	16-16	80	20	pièce
1039934	20-20	80	10	pièce
1039935	25-25	80	10	pièce
1039936	32-32	80	10	pièce

Uponor S-Press manchon égal PPSU

 1046401	40-40	960	5	pièce
1046402	50-50	576	3	pièce
1032881	63-63	384	1	pièce
1032882	75-75	384	1	pièce

Uponor S-Press PLUS manchon réduit PPSU

 1039937	20-16	80	20	pièce
1039938	25-16	80	10	pièce
1039939	25-20	80	10	pièce
1039940	32-25	80	10	pièce

Uponor S-Press manchon réduit PPSU

 1039941	40-25	960	5	pièce
1039942	40-32	960	5	pièce
1039943	50-32	1152	3	pièce
1046406	50-40	576	3	pièce
1032883	63-40	384	1	pièce
1032884	63-50	384	1	pièce
1032885	75-50	384	1	pièce
1032886	75-63	384	1	pièce

N° art.	Dimension	UL	UE	unité
---------	-----------	----	----	-------

Uponor S-Press PLUS T à sertir PPSU

 1039944	16-16-16	80	10	pièce
1039945	20-20-20	80	10	pièce
1039946	25-25-25	20	5	pièce
1039947	32-32-32	20	5	pièce

Uponor S-Press Té égal PPSU

 1046390	40-40-40	720	5	pièce
1046391	50-50-50	288	3	pièce
1032887	63-63-63	150	1	pièce
1032888	75-75-75	150	1	pièce

Uponor S-Press PLUS T réduit à sertir PPSU

 1039948	16-20-16	80	10	pièce
1039949	20-16-16	80	10	pièce
1039950	20-16-20	80	10	pièce
1039951	20-20-16	80	10	pièce
1039952	20-25-20	80	10	pièce
1039953	25-16-16	80	10	pièce
1039954	25-16-20	80	10	pièce
1039955	25-16-25	80	10	pièce
1039956	25-20-20	80	10	pièce
1039957	25-20-25	80	10	pièce
1039958	32-16-32	20	5	pièce
1039959	32-20-32	20	5	pièce
1039960	32-25-25	20	5	pièce
1039961	32-25-32	20	5	pièce

Uponor S-Press T réduit à sertir PPSU

 1039962	40-20-40	960	5	pièce
1039963	40-25-32	960	5	pièce
1039964	40-25-40	720	5	pièce
1039965	40-32-32	960	5	pièce
1039966	40-32-40	720	5	pièce
1039967	50-25-40	432	3	pièce
1039968	50-25-50	432	3	pièce
1039969	50-32-50	432	3	pièce

Uponor S-Press Té réduit PPSU

 1046400	50-40-50	288	3	pièce
1032889	63-25-63	150	1	pièce
1032890	63-32-63	150	1	pièce
1032891	63-40-63	150	1	pièce
1032892	75-32-75	150	1	pièce
1032893	75-40-75	150	1	pièce
1032894	75-50-75	150	1	pièce

Uponor S-Press PLUS 14

N° art.	Dimension	UL	UE	unité
---------	-----------	----	----	-------

Uponor S-Press raccord mâle

 1014513	14-R $\frac{1}{2}$ "MT	80	20	pièce
--	------------------------	----	----	-------

Uponor S-Press raccord femelle

 1014515	14-Rp $\frac{1}{2}$ "FT	80	20	pièce
--	-------------------------	----	----	-------

Uponor S-Press coude à sertir

 NEW 1133445	14-14	80	20	pièce
---	-------	----	----	-------

Uponor S-Press manchon

 1015154	14-14	80	10	pièce
--	-------	----	----	-------

Uponor S-Press manchon réduit

 1015162	16-14	80	20	pièce
--	-------	----	----	-------

Uponor S-Press Té

 1014886	14-14-14	80	10	pièce
--	----------	----	----	-------

Uponor S-Press Té réduit

 1014888	14-16-14	80	10	pièce
1014912	16-14-14	80	10	pièce
1014915	16-14-16	80	10	pièce

N° art.	Dimension	UL	UE	unité
---------	-----------	----	----	-------

Uponor S-Press adaptateur

 1014511	14-15CU	80	10	pièce
--	---------	----	----	-------

Uponor Smart Aqua culasse S-Press

 1015437	14-Rp $\frac{1}{2}$ "FT	40	10	pièce
--	-------------------------	----	----	-------

Uponor S-Press culasse double 90° long

 NEW 1133446	14-Rp $\frac{1}{2}$ "FT-14	40	10	pièce
---	----------------------------	----	----	-------

Uponor Smart Aqua adaptateur coudé S-Press

 1014654	14-12CU l=150mm	2880	20	pièce
---	-----------------	------	----	-------

Uponor Smart Radi adapt. coudé revêtu S-Press

 1015615	14-15CU l=350mm	640	20	pièce
--	-----------------	-----	----	-------

Uponor S-Press PLUS

N° art.	Dimension	UL	UE	unité
---------	-----------	----	----	-------

Uponor S-Press PLUS raccord mâle

 1070501	16-R $\frac{3}{8}$ "MT	80	20	pièce
1070502	16-R $\frac{1}{2}$ "MT	80	20	pièce
1070503	16-R $\frac{3}{4}$ "MT	120	15	pièce
1070504	20-R $\frac{1}{2}$ "MT	80	20	pièce
1070505	20-R $\frac{3}{4}$ "MT	80	10	pièce
1070506	20-R1"MT	80	10	pièce
1070507	25-R $\frac{3}{4}$ "MT	80	10	pièce
1070508	25-R1"MT	40	5	pièce
1070509	32-R1"MT	40	5	pièce
1070510	32-R1 $\frac{1}{4}$ "MT	20	5	pièce

Uponor S-Press raccord mâle

 1046901	40-R1 $\frac{1}{4}$ "MT	960	5	pièce
1046902	40-R1 $\frac{1}{2}$ "MT	960	5	pièce
1046905	50-R1 $\frac{1}{2}$ "MT	1152	3	pièce
1046906	50-R2"MT	576	3	pièce
1032895	63-R2"MT	336	1	pièce
1032896	75-R2 $\frac{1}{2}$ "MT	336	1	pièce

Uponor S-Press PLUS raccord mâle BENELUX

 1070511	16-R15mm CU	80	20	pièce
1070512	20-R22mm CU	3840	10	pièce
1070513	25-R22mm CU	3840	10	pièce

Uponor S-Press PLUS raccord femelle

 1070515	16-Rp $\frac{1}{2}$ "FT	80	20	pièce
1070516	20-Rp $\frac{1}{2}$ "FT	120	15	pièce
1070517	20-Rp $\frac{3}{4}$ "FT	80	10	pièce
1070518	20-Rp1"FT	80	20	pièce
1070519	25-Rp $\frac{3}{4}$ "FT	40	5	pièce
1070520	25-Rp1"FT	40	5	pièce
1070521	32-Rp1"FT	40	5	pièce
1070522	32-Rp1 $\frac{1}{4}$ "FT	20	5	pièce

Uponor S-Press raccord femelle

 1046903	40-Rp1 $\frac{1}{4}$ "FT	960	5	pièce
1046904	40-Rp1 $\frac{1}{2}$ "FT	960	5	pièce
1046907	50-Rp1 $\frac{1}{2}$ "FT	1152	3	pièce

Uponor S-Press PLUS coude à sertir

 1070523	16-16	80	20	pièce
1070524	20-20	80	10	pièce
1070525	25-25	40	5	pièce
1070526	32-32	20	5	pièce

N° art.	Dimension	UL	UE	unité
---------	-----------	----	----	-------

Uponor S-Press coude

 1046908	40-40	600	5	pièce
1046911	50-50	240	3	pièce

Uponor S-Press PLUS coude

 1070527	16-16	80	10	pièce
1070528	20-20	80	10	pièce
1070529	25-25	40	5	pièce
1070530	32-32	20	5	pièce

Uponor S-Press PLUS coude filetage mâle

 1070531	16-R $\frac{3}{8}$ "MT	80	20	pièce
1070532	16-R $\frac{1}{2}$ "MT	80	20	pièce
1070533	20-R $\frac{1}{2}$ "MT	80	10	pièce
1070534	20-R $\frac{3}{4}$ "MT	80	10	pièce
1070535	25-R $\frac{3}{4}$ "MT	40	5	pièce
1070536	25-R1"MT	40	5	pièce
1070537	32-R1"MT	20	5	pièce

Uponor S-Press coude fileté mâle

 1046909	40-R1 $\frac{1}{4}$ "MT	500	5	pièce
--	-------------------------	-----	---	-------

Uponor S-Press PLUS coude à sertir - CU

 1070538	16-G $\frac{3}{8}$ "MT/10CU	20	1	pièce
--	-----------------------------	----	---	-------

Uponor S-Press PLUS coude fil. femelle

 1070539	16-Rp $\frac{1}{2}$ "FT	80	10	pièce
1070540	20-Rp $\frac{1}{2}$ "FT	80	10	pièce
1070541	20-Rp $\frac{3}{4}$ "FT	40	10	pièce
1070542	25-Rp $\frac{3}{4}$ "FT	20	5	pièce
1070543	25-Rp1"FT	20	5	pièce
1070544	32-Rp1"FT	20	5	pièce

Uponor S-Press coude fileté femelle

 1046910	40-Rp1 $\frac{1}{2}$ "FT	500	5	pièce
1046912	50-Rp1 $\frac{1}{2}$ "FT	300	3	pièce

Uponor S-Press PLUS

N° art.	Dimension	UL	UE	unité
---------	-----------	----	----	-------

Uponor S-Press PLUS coude à sertir 45°

 1070545	25-25	20	5	pièce
1070546	32-32	20	5	pièce

Uponor S-Press coude 45°

 1046913	40-40	500	5	pièce
1046914	50-50	300	3	pièce

Uponor S-Press PLUS manchon

 1070547	16-16	80	20	pièce
1070548	20-20	80	10	pièce
1070549	25-25	80	10	pièce
1070550	32-32	40	5	pièce

Uponor S-Press PLUS manchon coulissant

 1118706	16-16	80	10	pièce
1118707	20-20	80	10	pièce
1118708	25-25	40	5	pièce
1118709	32-32	20	5	pièce
1118710	40-40	12	3	pièce

Uponor S-Press couplage

 1046932	40-40	960	5	pièce
1046935	50-50	576	3	pièce

Uponor S-Press PLUS manchon réduit

 1070552	20-16	80	20	pièce
1070553	25-16	80	10	pièce
1070554	25-20	80	10	pièce
1070555	32-20	80	10	pièce
1070556	32-25	80	10	pièce

Uponor S-Press manchon réduit

 1046930	40-25	960	5	pièce
1046931	40-32	960	5	pièce
1046933	50-32	1152	3	pièce
1046934	50-40	576	3	pièce

N° art.	Dimension	UL	UE	unité
---------	-----------	----	----	-------

Uponor S-Press PLUS T

 1070560	16-16-16	80	10	pièce
1070561	20-20-20	80	10	pièce
1070562	25-25-25	20	5	pièce
1070563	32-32-32	20	5	pièce

Uponor S-Press té égal

 1046921	40-40-40	400	5	pièce
1046928	50-50-50	300	3	pièce

Uponor S-Press PLUS T réduit

 1070566	16-20-16	80	10	pièce
1070567	20-16-16	40	10	pièce
1070568	20-16-20	80	20	pièce
1070569	20-20-16	80	20	pièce
1070570	20-25-16	40	10	pièce
1070571	20-25-20	40	10	pièce
1070572	25-16-16	40	5	pièce
1070573	25-16-20	40	5	pièce
1070574	25-16-25	20	5	pièce
1070575	25-20-16	40	5	pièce
1070576	25-20-20	40	5	pièce
1070577	25-20-25	20	5	pièce
1070578	25-25-16	20	5	pièce
1070579	25-32-25	20	5	pièce
1070580	32-16-32	20	5	pièce
1070581	32-20-32	20	5	pièce
1070582	32-25-25	20	5	pièce
1070583	32-25-32	20	5	pièce

Uponor S-Press T réduit

 1046916	40-20-40	400	5	pièce
1046917	40-25-32	500	5	pièce
1046918	40-25-40	400	5	pièce
1046919	40-32-32	400	5	pièce
1046920	40-32-40	400	5	pièce
1046924	50-25-40	300	3	pièce
1046925	50-25-50	240	3	pièce
1046926	50-32-50	300	3	pièce
1046927	50-40-50	300	3	pièce

Uponor S-Press PLUS T filetage mâle

 1070592	16-R $\frac{1}{2}$ \" data-bbox="506 811 558 843"/>MT-16	40	10	pièce
1070593	25-R $\frac{3}{4}$ \" data-bbox="506 831 558 863"/>MT-25	20	5	pièce
1070594	32-R $\frac{3}{4}$ \" data-bbox="506 851 558 883"/>MT-32	20	5	pièce

Uponor S-Press PLUS

N° art.	Dimension	UL	UE	unité
---------	-----------	----	----	-------

Uponor S-Press PLUS T filetage femelle

 1070595	16-Rp½"FT-16	40	10	pièce
1070596	20-Rp½"FT-20	60	15	pièce
1070597	20-Rp¾"FT-20	40	10	pièce
1070598	25-Rp½"FT-25	20	5	pièce
1070599	25-Rp¾"FT-25	20	5	pièce
1070600	32-Rp½"FT-32	20	5	pièce
1070601	32-Rp¾"FT-32	20	5	pièce

Uponor S-Press té femelle

 1046922	40-Rp½"FT-40	500	5	pièce
1046923	40-Rp¾"FT-40	400	5	pièce
1046929	50-Rp1"FT-50	240	3	pièce

Uponor S-Press PLUS adapt. écrou tourn.

 1070708	16-G¾"SN	25	1	pièce
1070602	16-G½"SN	30	1	pièce
1070603	16-G¾"SN	20	1	pièce
1070604	20-G½"SN	20	1	pièce
1070605	20-G¾"SN	20	1	pièce
1070606	25-G¾"SN	15	1	pièce
1070607	25-G1"SN	15	1	pièce
1070608	25-G1 ¼"SN	10	1	pièce
1070609	32-G1"SN	10	1	pièce
1070610	32-G1 ¼"SN	10	1	pièce

Uponor S-Press rac. à visser filet fem.

 1060094	40-G1 ¼"SN	960	5	pièce
1046937	40-G1 ½"SN	960	5	pièce
1060095	50-G1 ½"SN	1152	3	pièce
1046938	50-G1 ¾"SN	1152	3	pièce
1046939	50-G2"SN	576	3	pièce

Uponor S-Press PLUS coude écrou tournant

 1070611	16-G¾"SN	20	1	pièce
1070612	16-G½"SN	20	1	pièce
1105818	16-G¾"SN	10	1	pièce
1070613	20-G½"SN	20	1	pièce
1105819	20-G¾"SN	10	1	pièce
1070614	25-G¾"SN	10	1	pièce

N° art.	Dimension	UL	UE	unité
---------	-----------	----	----	-------

Uponor S-Press PLUS culasse M

 1070638	16-Rp¾"FT	40	10	pièce
1070639	16-Rp½"FT	40	10	pièce
1070640	20-Rp½"FT	40	10	pièce
1070641	20-Rp¾"FT	20	5	pièce
1070642	25-Rp¾"FT	20	5	pièce

Uponor S-Press PLUS culasse L

 1070644	16-Rp½"FT	40	10	pièce
1070645	20-Rp½"FT	40	10	pièce

Uponor S-Press PLUS culasse XL

 1070646	16-Rp½"FT	40	10	pièce
1070647	20-Rp½"FT	40	10	pièce

Uponor S-Press PLUS Sound set 2 panneaux muraux

 1121193	16-20	192	1	jeu
---	-------	-----	---	-----

Uponor S-Press PLUS culasse mur. + cache

 1070643	16-Rp¾"FT	20	1	pièce
--	-----------	----	---	-------

Uponor S-Press PLUS culasse murale Gemini

 1070665	16-Rp½"FT	4800	75	pièce
--	-----------	------	----	-------

Uponor S-Press PLUS culasse en U

 1070629	16-Rp½"FT-16	20	5	pièce
1070630	20-Rp½"FT-20	960	5	pièce
1070631	20-Rp½"FT-16	960	5	pièce
1070632	16-Rp½"FT-20	960	5	pièce
1070633	25-Rp½"FT-25	576	3	pièce
1070634	25-Rp½"FT-20	576	3	pièce
1070635	20-Rp½"FT-25	576	3	pièce

Uponor S-Press PLUS Panneau de paroi en U insonorisé

 1121194	16-20	384	1	pièce
--	-------	-----	---	-------

Uponor S-Press PLUS

N° art.	Dimension	UL	UE	unité
---------	-----------	----	----	-------

Uponor S-Press PLUS raccord U mitigeur

	1070636	16-16-R $\frac{1}{2}$ "MT	960	5	pièce
	1070637	20-20-R $\frac{3}{4}$ "MT	960	5	pièce

Uponor S-Press PLUS culasse double 90° long

	1070648	16-Rp $\frac{1}{2}$ "FT-16	40	10	pièce
	1070649	20-Rp $\frac{1}{2}$ "FT-20	40	10	pièce

Uponor S-Press PLUS culasse coudée pour chasse WC encastrée

	1070657	16-Rp $\frac{1}{2}$ "FT	10	1	pièce
---	----------------	-------------------------	----	---	-------

Uponor S-Press PLUS raccord en T Geberit

	1070659	16-G $\frac{1}{2}$ "FT-16	10	1	pièce
---	----------------	---------------------------	----	---	-------

Uponor S-Press PLUS coude pour réservoir Geberit

	1070658	16- $\frac{1}{2}$ "FT	80	20	pièce
---	----------------	-----------------------	----	----	-------

Uponor Smart Aqua adapt. rés. chasse eau Geberit

	1058097	16- $\frac{1}{2}$ "FT	25	1	pièce
---	----------------	-----------------------	----	---	-------

Uponor S-Press PLUS bouchon

	1070621	16	160	40	pièce
	1070622	20	7680	20	pièce
	1070623	25	3840	10	pièce
	1070624	32	1920	5	pièce

N° art.	Dimension	UL	UE	unité
---------	-----------	----	----	-------

Uponor MLC bouchon test de pression

	1013754	14	7680	20	pièce
	1013756	16	7680	20	pièce
	1013760	20	3840	20	pièce
	1013762	25	3840	10	pièce
	1013764	32	3840	10	pièce
	1013765	40	960	5	pièce

Uponor MLC joint torique racc. à sertir

	1013798	14	10000	10	pièce
	1013799	16	1000	10	pièce
	1013801	20	1000	10	pièce
	1013802	25	500	10	pièce
	1013803	32	500	10	pièce
	1013804	40	10000	10	pièce

Uponor S-Press PLUS un. mont. prot. ac.

	1070666	16-Rp $\frac{1}{2}$ "FT c/c150mm	150	5	pièce
---	----------------	----------------------------------	-----	---	-------

Uponor S-Press PLUS unité mont. culasses

	1070661	16-Rp $\frac{1}{2}$ "FT c/c80mm	5	1	pièce
	1070662	16-Rp $\frac{1}{2}$ "FT c/c150mm	380	5	pièce

Uponor S-Press PLUS unité mont. culasses Gemini

	1070663	16-Rp $\frac{1}{2}$ "FT c/c120mm	720	5	pièce
	1070664	16-Rp $\frac{1}{2}$ "FT c/c150mm	720	5	pièce

Uponor S-Press PLUS canne coudée

	1070650	16-15CU l=150mm	2880	20	pièce
	1070651	16-12CU l=150mm	2880	20	pièce

Uponor S-Press PLUS traversée droite

	1070652	16-G $\frac{1}{2}$ "FT	5	1	pièce
---	----------------	------------------------	---	---	-------

Uponor S-Press PLUS culasse LWC

	1070653	16-Rp $\frac{1}{2}$ "FT l=25	5	1	pièce
	1070654	16-Rp $\frac{1}{2}$ "FT l=35	5	1	pièce

Uponor S-Press PLUS culasse en U LWC

	1070655	16-Rp $\frac{1}{2}$ "FT-16 l=25	5	1	pièce
	1070656	16-Rp $\frac{1}{2}$ "FT-16 l=35	5	1	pièce

Uponor S-Press PLUS

N° art.	Dimension	UL	UE	unité
---------	-----------	----	----	-------

Uponor S-Press PLUS plaque de montage

 1121197	80/150mm	5	1	pièce
--	----------	---	---	-------

Uponor S-Press PLUS étrier de montage

 1121196	100mm	5	1	pièce
1121195	80/150mm	5	1	pièce

Uponor Smart Aqua étrier de montage Gemini

 1059824	120mm	5	1	pièce
1059825	150mm	5	1	pièce

Uponor Smart Aqua équerre mont. simple

 1057843		5	1	pièce
--	--	---	---	-------

Uponor Smart Aqua profilé de montage

 1057844	2m	10	1	pièce
---	----	----	---	-------

Uponor Smart Aqua sup. de mont. outil de cintr.

 1015424	2m	100	1	pièce
--	----	-----	---	-------

Uponor Smart Aqua 10 goupilles + 20 vis

 1057847		-	1	jeu
--	--	---	---	-----

Bouchons spéciaux Nathan

 50003600	rood	-	200	pièce
50003500	blauw	-	200	pièce

VEUILLEZ NOTER : achat par unité d'emballage de 200 pièces et/ou multiples de celles-ci.

N° art.	Dimension	UL	UE	unité
---------	-----------	----	----	-------

Uponor S-Press raccord V

 1090678	16-15CU-SST	10	1	pièce
1090679	20-22CU-SST	5	1	pièce
1090680	25-22CU-SST	5	1	pièce
1090681	32-28CU-SST	5	1	pièce

Uponor S-Press raccord M

 1090682	16-15CU-SST	10	1	pièce
1090683	20-22CU-SST	5	1	pièce
1090684	25-22CU-SST	5	1	pièce
1090685	32-28CU-SST	5	1	pièce

Uponor S-Press PLUS adaptateur à sertir

 1070705	16-10CU	80	20	pièce
1070706	16-12CU	80	20	pièce
1070615	16-15CU	160	20	pièce
1070707	20-15CU	3840	10	pièce
1070616	20-18CU	40	10	pièce
1070617	20-22CU	60	15	pièce
1070618	25-22CU	20	5	pièce
1070619	25-28CU	1920	5	pièce
1070620	32-28CU	20	5	pièce

Uponor S-Press manchon réduit

 1015172	18-16	80	20	pièce
1015185	20-18	80	10	pièce

Uponor S-Press adaptateur SST

 OUT 1089056	16-15SST	10	1	pièce
OUT 1089057	20-22SST	10	1	pièce
OUT 1089058	25-22SST	5	1	pièce
OUT 1089059	32-28SST	5	1	pièce

 Livraison dans la limite des stocks disponibles.
L'article expire au cours de l'année.

Uponor S-Press PLUS

N° art.	Dimension	UL	UE	unité
---------	-----------	----	----	-------

Uponor S-Press PLUS T de croisement

 1070685	16-16-16	192	1	pièce
1070686	20-16-16	192	1	pièce
1070687	20-16-20	192	1	pièce
1070688	20-20-20	192	1	pièce

Uponor S-Press PLUS T de croisement insulated

 1070689	16-16-16	192	1	pièce
1070690	20-16-16	192	1	pièce
1070691	20-16-20	192	1	pièce
1070692	20-20-20	192	1	pièce

Uponor Smart Radi boîte de connexion

 1013134	16 h=215mm	240	10	pièce
1007077	16 h=240mm	240	10	pièce

Uponor S-Press PLUS canne coudée étamée

 1070678	16-15CU l=350mm	1680	20	pièce
1070679	16-15CU l=1000mm	400	20	pièce
1070680	25-22CU l=250mm	640	20	pièce

Uponor S-Press PLUS canne en T à sertir

 1070681	16-15CU-16 l=350mm	600	20	pièce
1070682	20-15CU-20 l=350mm	600	20	pièce

N° art.	Dimension	UL	UE	unité
---------	-----------	----	----	-------

Uponor S-Press PLUS adap. pour plinthe

 1070693	16-G½"MT-16	192	1	pièce
1070694	16-G½"MT-20	192	1	pièce
1070695	16-G½"MT-0	192	1	pièce
1070696	20-G½"MT-16	192	1	pièce
1094219	0-G½"MT-16	192	1	pièce
1070697	20-G½"MT-20	192	1	pièce

Uponor Smart Base angle de plinthe SL

 1014060	15x1	25	1	jeu
--	------	----	---	-----

Uponor S-Press PLUS unité mont. culasses radi

 1070683	16-Rp½"FT c/c35mm	720	5	pièce
1070684	16-Rp½"FT c/c50mm	720	5	pièce

Uponor S-Press PLUS

N° art.	Dimension	UL	UE	unité
---------	-----------	----	----	-------

Uponor Smart Radi adaptateur platine



1015425	G½"MT-15CU l=350mm	640	20	pièce
----------------	--------------------	-----	----	-------

Uponor Smart Radi adaptateur



1013830	15CU-¾" Euro	80	10	pièce
----------------	--------------	----	----	-------

Uponor Smart Radi adaptateur scellé



1013906	G¾"MT-G½"MT	80	10	pièce
----------------	-------------	----	----	-------

Uponor Smart Radi raccord à compression Danfoss



1013970	16-G½"MT	20	1	pièce
----------------	----------	----	---	-------

Uponor Smart Radi raccord à compression Heimeier



1013978	16-G½"MT	20	1	pièce
----------------	----------	----	---	-------

Uponor Smart Radi raccord à compression Oventrop



1014016	16-G½"MT	20	1	pièce
----------------	----------	----	---	-------

Uponor Smart Radi ens. connexion UNIFIX



1011364		100	10	pièce
----------------	--	-----	----	-------

Uponor Smart Radi rosace divisible



1011370	16 white	20000	50	pièce
----------------	----------	-------	----	-------

Uponor Smart Radi rosace divisible



1011373	14-20 white double	500	50	pièce
----------------	--------------------	-----	----	-------

N° art.	Dimension	UL	UE	unité
---------	-----------	----	----	-------

Uponor S-Press vanne therm. Aquastrom T plus



1013243	G¾"MT	300	1	pièce
----------------	-------	-----	---	-------

Uponor RTM

N° art.	Dimension	UL	UE	unité
---------	-----------	----	----	-------

Uponor RTM coude PPSU

 1048547	16-16	40	1	pièce
1048548	20-20	25	1	pièce
1048549	25-25	15	1	pièce

Uponor RTM Manchon PPSU

 1048542	16-16	40	1	pièce
1048543	20-20	30	1	pièce
1048544	25-25	20	1	pièce

Uponor RTM manchon réduit PPSU

 1048545	20-16	35	1	pièce
1048546	25-20	25	1	pièce

Uponor RTM Té PPSU

 1048550	16-16-16	24	1	pièce
1048551	20-20-20	20	1	pièce
1048552	25-25-25	10	1	pièce

Uponor RTM Té réduit PPSU

 1048553	20-16-20	20	1	pièce
1048554	20-16-16	20	1	pièce
1048555	20-20-16	20	1	pièce
1048556	25-20-25	14	1	pièce
1048557	25-20-20	14	1	pièce

Uponor RTM Raccord mâle

 1048566	16-R $\frac{1}{2}$ "MT	48	1	pièce
1048567	20-R $\frac{1}{2}$ "MT	36	1	pièce
1048568	20-R $\frac{3}{4}$ "MT	25	1	pièce
1048569	25-R $\frac{3}{4}$ "MT	20	1	pièce
1048570	25-R1"MT	20	1	pièce

Uponor RTM Raccord mâle BENELUX

 1062842	16-15mm	10	1	pièce
1062843	20-22mm	10	1	pièce
1062844	25-22mm	5	1	pièce

N° art.	Dimension	UL	UE	unité
---------	-----------	----	----	-------

Uponor RTM Raccord femelle

 1048581	16-Rp $\frac{1}{2}$ "FT	48	1	pièce
1048582	20-Rp $\frac{1}{2}$ "FT	36	1	pièce
1048583	20-Rp $\frac{3}{4}$ "FT	25	1	pièce
1048584	25-Rp $\frac{3}{4}$ "FT	25	1	pièce
1048585	25-Rp1"FT	20	1	pièce

Uponor RTM adapt. coudé filetage ext.

 1048599	16-R $\frac{1}{2}$ "MT	30	1	pièce
1048600	20-R $\frac{1}{2}$ "MT	20	1	pièce
1048601	20-R $\frac{3}{4}$ "MT	20	1	pièce
1048602	25-R $\frac{3}{4}$ "MT	15	1	pièce

Uponor RTM adapt. coudé filetage int.

 1048590	16-Rp $\frac{1}{2}$ "FT	48	1	pièce
1048591	20-Rp $\frac{1}{2}$ "FT	30	1	pièce
1048592	20-Rp $\frac{3}{4}$ "FT	20	1	pièce
1048593	25-Rp $\frac{3}{4}$ "FT	20	1	pièce
1048594	25-Rp1"FT	20	1	pièce

Uponor RTM Manchon réduit

 1048573	25-16	20	1	pièce
--	-------	----	---	-------

Uponor RTM Té réduit

 1059011	16-20-16	20	1	pièce
--	----------	----	---	-------

Uponor RTM adapt. té filetage int.

 1048587	16-Rp $\frac{1}{2}$ "FT-16	30	1	pièce
1048588	20-Rp $\frac{1}{2}$ "FT-20	20	1	pièce
1048589	20-Rp $\frac{3}{4}$ "FT-20	20	1	pièce

Uponor RTM adapt. écrou tournant

 1057375	16- $\frac{1}{2}$ "SN	24	1	pièce
1057376	20- $\frac{3}{4}$ "SN	24	1	pièce

Uponor RTM

N° art.	Dimension	UL	UE	unité
---------	-----------	----	----	-------

Uponor RTM adaptateur

 1048604	16-G $\frac{3}{4}$ "Euro	25	1	pièce
1048605	20-G $\frac{3}{4}$ "Euro	25	1	pièce

Uponor RTM Adaptateur

 1048603	16-15CU	40	1	pièce
1057377	25-22CU	20	1	pièce

Uponor RTM bouchon à sertir

 1059013	16	48	1	pièce
--	----	----	---	-------

Uponor Smart Aqua culasse en U RTM

 1061621	16-Rp $\frac{1}{2}$ "FT-16	20	5	pièce
---	----------------------------	----	---	-------

Uponor Smart Aqua culasse RTM

 1048596	16-Rp $\frac{1}{2}$ "FT	20	1	pièce
1048597	20-Rp $\frac{1}{2}$ "FT	20	1	pièce
1048598	20-Rp $\frac{3}{4}$ "FT	20	1	pièce

Uponor Smart Aqua coude rés. ch. d'eau RTM Geberit

 1057380	16-G $\frac{1}{2}$ "FT	35	1	pièce
--	------------------------	----	---	-------

N° art.	Dimension	UL	UE	unité
---------	-----------	----	----	-------

Uponor S-Press PLUS plaque de montage

 1121197	80/150mm	5	1	pièce
--	----------	---	---	-------

Uponor S-Press PLUS étrier de montage

 1121196	100mm	5	1	pièce
1121195	80/150mm	5	1	pièce

Uponor Smart Aqua étrier de montage Gemini

 1059824	120mm	5	1	pièce
1059825	150mm	5	1	pièce

Uponor Smart Radi adaptateur coudé RTM

 1057379	16-15CU l=200mm	15	1	pièce
---	-----------------	----	---	-------

Uponor RS

Système de fixation modulaire pour canalisations répartitrices et ascendantes



RS 2 Adaptateur	RS 2 Composant de base	RS 3 Composant de base	RS 3 Adaptateur
40, 50, 63, 75 1½", 2", 2½" ½", 1", 2", 2½" 16, 20, 25, 32 DN 65 (PN 6/PN 16) 130 mm 5 mm	 	 	90, 110 3" ½", 3" DN 80 (PN 6/PN 16) DN 100 (PN 6/PN 16) 210 mm 5 mm

Uponor RS

N° art.	Dimension	UL	UE	unité
---------	-----------	----	----	-------

Uponor RS couplage

 1029144	RS2-RS2	480	1	pièce
1029145	RS3-RS3	480	1	pièce

Uponor RS coude 90°

 1029138	RS2-RS2	336	1	pièce
1029139	RS3-RS3	240	1	pièce

Uponor RS coude 45°

 1029140	RS2-RS2	336	1	pièce
1029141	RS3-RS3	175	1	pièce

Uponor RS té égal

 1029142	RS2-RS2-RS2	336	1	pièce
1029143	RS3-RS3-RS3	175	1	pièce

N° art.	Dimension	UL	UE	unité
---------	-----------	----	----	-------

Uponor RS manchon réduit

 1029146	RS3-RS2	480	1	pièce
--	---------	-----	---	-------

Uponor RS manchon mâle-mâle

 1046750	RS2-RS2 l=5mm	480	1	pièce
1046751	RS3-RS3 l=5mm	240	1	pièce

Uponor RS rallonge mâle

 1046477	RS2-RS2 l=130mm	240	1	pièce
1046478	RS3-RS3 l=210mm	96	1	pièce

Uponor RS

N° art.	Dimension	UL	UE	unité
---------	-----------	----	----	-------

Uponor RS Embout-réduction S-Press

 1059397	16-RS2	480	1	pièce
--	--------	-----	---	-------

Uponor RS adaptateur S-Press PLUS

 1095818	20-RS2	378	1	pièce
1095819	25-RS2	378	1	pièce
1095820	32-RS2	378	1	pièce

Uponor RS Adaptateur S-Press

 1046940	40-RS2	480	1	pièce
1046941	50-RS2	480	1	pièce
1029125	63-RS2	400	1	pièce
1029126	75-RS2	400	1	pièce
1029127	90-RS3	240	1	pièce
1029128	110-RS3	240	1	pièce

Uponor RS raccord mâle

 1059402	R1 ½"MT-RS2	480	1	pièce
1029131	R2"MT-RS2	480	1	pièce
1029132	R2 ½"MT-RS2	480	1	pièce
1029133	R3"MT-RS3	240	1	pièce

Uponor RS raccord femelle

 1059403	Rp½"FT-RS2	480	1	pièce
1029134	Rp1"FT-RS2	480	1	pièce
1029135	Rp2"FT-RS2	480	1	pièce
1029136	Rp2 ½"FT-RS2	480	1	pièce
1059404	Rp½"FT-RS3	336	1	pièce
1029137	Rp3"FT-RS3	240	1	pièce

Uponor RS adaptateur à bride

 1059398	RS2-DN65 (PN6)	144	1	pièce
1059399	RS2-DN65 (PN16)	90	1	pièce
1059400	RS3-DN80 (PN6)	90	1	pièce
1029129	RS3-DN80 (PN16)	90	1	pièce
1059401	RS3-DN100 (PN6)	90	1	pièce
1029130	RS3-DN100 (PN16)	90	1	pièce

N° art.	Dimension	UL	UE	unité
---------	-----------	----	----	-------

Uponor RS tige de verrouillage

 1042921	RS2 zwart	5000	10	pièce
1042922	RS3 grijs	-	10	pièce







Systemes Uponor pour chauffer et refroidir

	Type d'installation	Epaisseur de la plaque	Hauteur de montage minimale* mm	Nom du systeme	Description	Conduites associees	Dimension (mm)	
SOL	CONSTRUCTION HUMIDE	Pose de la plaque à plots, autocollante	—	15	Uponor Minitec	très faible hauteur de montage, directement sur le support existant (chape, tuiles, bois...)	Comfort Pipe	9,9
		Bandes d'accrochage	DES 25-2, 30-2, 30-3, 35-3 WLS032 25-2, DEO 15	74	Uponor Klett	Plaque et conduite avec microdenture. Mode de pose le plus rapide, aucun endommagement du film de chape	Klett Comfort Pipe PLUS Klett MLCP RED	14, 16 16
		Bandes accrochantes sur isolation existante	—	74	Uponor Klett Twinboard	Pose par bandes accrochantes sur isolation existante au moyen de dalles de plancher à compartiments creux 3 mm	Klett Comfort Pipe PLUS Klett MLCP RED	14, 16 16
		Bandes accrochantes y compris isolation laine minérale	30	74	Uponor Klett Silent	Pose par bandes accrochantes sur plaques en laine minérale, adjudications alternatives	Klett Comfort Pipe PLUS Klett MLCP RED	14, 16 16
		Dans le film à plots	—	30	Uponor Nubos	Choix libre de la couche d'isolation	Comfort Pipe PLUS Blue Comfort Pipe PLUS MLCP RED	16 16 14, 16
		Dans la plaque à plots	11 ou 30-2	82	Uponor Tecto	Montage rapide des conduites, plaques pour les plafonds de séparation entre étages, maintien sûr	Comfort Pipe PLUS Blue Comfort Pipe PLUS MLCP RED	16 14, 17 14, 16
		Dans la plaque à plots	11 ou 30-2	78	Uponor Nubos	Simple à utiliser, distances de montage conformément aux normes en vigueur	Comfort Pipe PLUS Blue Comfort Pipe PLUS MLCP RED	16 16 14, 16
		sur treillis soudés avec clip	—	83	Uponor Classic	Isolation acoustique optimale (isolation en laine minérale sur site). Séparation des métiers chape/ chauffage, grands circuits de chauffage	Comfort Pipe PLUS Blue Comfort Pipe PLUS Magna Pipe PLUS	16, 20 17 20
		Tacker et rail en U	EPS DEO 20, 30 DES 20-2, 25-2, 30-2, 30-3, 35-3, 40-3	75	Uponor Tacker	Solution la plus avantageuse. Différentes plaques à isolation thermique et contre les bruits d'impact disponibles	Comfort Pipe PLUS Blue Comfort Pipe PLUS MLCP RED	16 16, 17 14, 16
CONSTRUCTION A SEC	Dans des plaques EPS préformées et lamelles conductrices de chaleur en aluminium	25	50	Uponor Siccus 14	faible poids, immédiatement utilisable, capacité portante élevée	Comfort Pipe PLUS MLCP RED	14 14	
	Avec tapis de câble cousu, FBH électrique	—	5	Uponor Comfort E tapis de câble	Tapis de câble cousu, très faible hauteur de montage, convient pour pratiquement tous les supports solides, y compris thermostat, haute réactivité	—		

		Type d'installation	Epaisseur de la plaque	Hauteur de montage minimale* mm	Nom du système	Description	Conduites associées	Dimension (mm)
MURALE	HUMIDE	Sous l'enduit, avec rail de serrage	—	32	Uponor Fix	Pose efficace et sans torsion du grand rouleau avec un minimum de pertes	Comfort Pipe Comfort Pipe PLUS MLCP RED	9,9 14 14
	CONSTRUCTION A SEC	Dans des plaques EPS préformées	25	30	Uponor Siccus Wall	Ne nécessite aucun temps de séchage ; bref temps d'échauffement	Comfort Pipe PLUS MLCP RED	14 14
		Sur profilés CD 60/27, plaque de plâtre avec conduites de chauffage intégrées	—	15	Uponor Renovis	Plaque en plâtre renforcée de fibres de verre 15 mm, montage comme panneau à cloison sèche sur les surfaces murales	Comfort Pipe (intégré)	9,9
PLAFOND	HUMIDE	Sous l'enduit, avec rail de serrage	—	32	Uponor Fix	Pose efficace et sans torsion du grand rouleau avec un minimum de pertes	Comfort Pipe	9,9
	CONSTRUCTION A SEC	Sur profilés CD 60/27, plaque de plâtre avec conduites de chauffage intégrées	—	15	Uponor Renovis	Rendements de pose élevés sur profilés CD	Comfort Pipe (intégré)	9,9
		Sous-construction standard	—	15	Uponor Thermatop M	Revêtements de plafond sans joints ni orientation visible	Uni Pipe PLUS	16
AUTRES APPLICATIONS	HALLS	PLANCHERS CHAUFFANTS INDUSTRIELS						
		sur rail de serrage			Uponor Magna	Liberté absolue d'aménagement sans éléments optiques gênants	Comfort Pipe PLUS Blue Magna Pipe PLUS	20
		sur tapis en acier						20, 25
	TABULATIONS	ACTIVATION DU NOYAU DE BÉTON						
		Module préfabriqué sur tapis en acier (armature)			Uponor Contec	Pour installation dans le noyau de béton	Magna Pipe PLUS	20
		A proximité de la surface			Uponor Contec ON	Grille en nid d'abeilles avec conduites préparées pour un montage à proximité de la surface dans le coffrage en béton	Comfort Pipe PLUS	14
	CONSTRUCTION A SEC	REVÊTEMENTS SPORTIFS						
		Dans les halls de sports	30		Uponor Siccus Sport	pour les sols à élasticité surfacique avec construction en sandwich	Comfort Pipe PLUS MLC blanc	14 14
		Dans les halls de sports			Uponor Sport	Pour installation entre les dalles des sols de salles omnisports à élasticité surfacique	Magna Pipe PLUS	25
	SURFACE LIBRE	SYSTÈME DE DÉNEIGEMENT ET DÉGIVRAGE / PELOUSES						
Empêche la formation du verglas et le tenue de la neige sur les surfaces extérieures				Uponor Meltaway	Montage par rail de serrage, pour garantir des chemins d'accès sûr, p.ex. les rampes et voies d'accès aux cliniques et hôpitaux, héliports, parkings, voies d'accès, terrains d'aviation, etc.	Magna Pipe PLUS	20, 25	

Chauffage surface

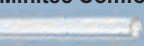
Conduites Uponor pour le chauffage/refroidissement de surface

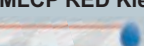
Type	Di- mension [mm]	Barrière de diffusion	Couleur de la conduite, Marquage	Pression [bar]	Tempé- rature [°C]	Lon- gueur [m]	N° art.	DIN-Certco N° certificat
Comfort Pipe PLUS 	14 x 2,0	PE-Xa avec barrière de diffusion à l'oxygène en EVOH	blanc, 2 bandes bleues	6	70	120 240 640 960	1062883 1062884 1088166 1062885	3V372
	16 x 2,0	PE-Xa avec barrière de diffusion à l'oxygène en EVOH	blanc, 2 bandes bleues	6	70	120 240 640	1062044 1062045 1062046	3V372
	17 x 2,0	PE-Xa avec barrière de diffusion à l'oxygène en EVOH	blanc, 2 bandes bleues	6	70	120 240 480 640	1034535 1009226 1086340 1009227	3V372
	20 x 2,0	PE-Xa avec barrière de diffusion à l'oxygène en EVOH	blanc, 2 bandes bleues	6	70	60	1009229	3V372
Comfort Pipe PLUS Blue 	16 x 2,0	PE-Xa avec barrière de diffusion à l'oxygène en EVOH	blanc, 2 bandes bleues	6	70	640	1126541	3V372 ISCC- Certificatie
	20 x 2,0	PE-Xa avec barrière de diffusion à l'oxygène en EVOH	blanc, 2 bandes bleues	6	70	480	1126542	3V372 ISCC- Certificatie
Uponor Comfort Pipe PN10 	16 x 2,2	PE-Xa avec barrière de diffusion à l'oxygène en EVOH	nature	10	70	240 640	1119470 1119471	
	20 x 2,8	PE-Xa avec barrière de diffusion à l'oxygène en EVOH	nature	10	70	240 640	1119472 1119533	
Klett Comfort Pipe PLUS 	14 x 2,0	PE-Xa avec barrière de diffusion à l'oxygène en EVOH	blanc, 2 bandes bleues, avec velcro	6	70	240 640	1088479 1088480	3V372
	16 x 2,0	PE-Xa avec barrière de diffusion à l'oxygène en EVOH	blanc, 2 bandes bleues, avec velcro	6	70	240 640	1087302 1087303	3V372
Magna Pipe PLUS 	20 x 2,0	PE-Xa avec barrière de diffusion à l'oxygène en EVOH	blanc, 2 bandes bleues	6	70	240 480	1091275 1091276	3V415
	25 x 2,3	PE-Xa avec barrière de diffusion à l'oxygène en EVOH	blanc, 2 bandes bleues	6	70	300 640	1091277 1091278	3V415
Minitec Comfort Pipe 	9,9 x 1,1	PE-Xa avec barrière de diffusion à l'oxygène en EVOH	nature, 1 bande bleue	6	70	60 120 480	1063287 1063288 1063381	3V279
MLC pipe wit 	14 x 2,0	Conduite composite avec AL	conduite blanche	10	80	200	1013366	
MLCP RED 	14 x 1,6	Conduite composite avec AL	conduite rouge	4	60	240 480	1096010 1096011	3V286
	16 x 2,0	Conduite composite avec AL	conduite rouge	4	60	240 480	1096012 1096013	3V286
MLCP RED Klett 	16 x 2,0	Conduite composite avec AL	conduite blanche, 2 bandes rouges, avec velcro	4	60	240 480	1096014 1096015	3V286

Technique de raccordement, raccords et outils

Raccordements vissés (par anneau de serrage)



Clé plate conventionnelle



Raccords Quick et Easy



Outils d'expansion Q+E



anneaux de retenue correspondants



rapex raccords à sertir



rapex mâchoires



Raccords à sertir Smart



Mâchoires MLC UPP1 et KSP0



Raccords S-Press et S-Press-PLUS



Vario/Fit 14x2,0	M12 & M18	nature eval	14	14	-
Vario/Fit 16x2,0	M12 & M18	nature eval et blanc	16	16	-
Vario/Fit 17x2,0	M12 & M18	nature eval et blanc	17	-	-
Vario/Fit 20x1,9/2,0	M12 & M18	nature eval et blanc	-	20	-
Vario/Fit 16x1,8/2,0	M12 & M18	nature eval et blanc	16	16	-
Vario/Fit 20x1,9/2,0	M12 & M18	nature eval et blanc	-	20	-
Flex-X 16x2,2	M12 & M18	blanc	-	-	-
Flex-X 20x2,8	M12 & M18	blanc	-	-	-
Vario/Fit 14x2,0	M12 & M18	natural eval	14	14	-
Vario/Fit 16x1,8/2,0	M12 & M18	natural eval & blanc	16	16	-
Vario/Fit 20x1,9/2,0	M12 & M18	natural eval & blanc	-	20	-
Vario/Fit 25x2,3	M12 & M18	natural eval & blanc	25	-	-
Vario & Minitec 9,9 x 1,1	Hand, M12 & M18	Minitec PEX	-	-	-
Uni-X 14-3/4 Euro	-	-	-	-	14
Vario MLCP RED 14x1,6 Euro	-	-	-	-	14 MLCP RED Press-Raccords
Uni-X 16-3/4 Euro	-	-	-	-	16
Uni-X 16-3/4 Euro	-	-	-	-	16

Uponor 10 bar UFH chauffage par le sol

N° art.	Dimension	UL	UE	unité
---------	-----------	----	----	-------

Uponor Comfort Pipe PN10

 1119470	16x2,2 240m	1440	240	m
1119471	16x2,2 640m	1280	640	m
1119472	20x2,8 240m	960	240	m
1119533	20x2,8 480m	960	480	m

Uponor Flex-X raccord à vis Eurocône PEX

 1045542	16x2,2-3/4"FT Euro	100	10	jeu
1045543	20x2,8-3/4"FT Euro	100	10	jeu

Uponor Q&E manchon PPSU

 1008669	16-16	100	5	pièce
1008932	20-20	80	5	pièce

Uponor Q&E manchon PPSU

 1057453	16	900	20	pièce
1057454	20	520	20	pièce

N° art.	Dimension	UL	UE	unité
---------	-----------	----	----	-------

Uponor Q&E outil d'expansion avec tête M12

 1119379	16RS/20/25 10bar	-	1	jeu
--	------------------	---	---	-----

Uponor Q&E tête d'expansion M12/M18

 1119381	16x1,8/2,0/2,2	-	1	pièce
1119383	20x2,8	-	1	pièce

Uponor Minitec

N° art.	Dimension	UL	UE	unité
---------	-----------	----	----	-------

Uponor Minitec support adhésive Minitec

 1005261	15,4m ² 9,9x1,1 1100x700x12mm	123,2	15,4	m ²
--	---	-------	------	----------------

Uponor Fix Bornier

 1005274	9,9mm c/c20mm 2,5m	25	2,5	m
--	--------------------	----	-----	---

Uponor Minitec ruban périph., auto-adh.

 1005267	20m 80x8mm	200	20	m
--	------------	-----	----	---

Uponor Minitec profilé joint d'expansion

 1085980	0,9m 40x10mm	600	10	pièce
1085981	1,3m 40x10mm	600	10	pièce

Uponor Minitec tube Comfort Pipe

 1063287	9,9x1,1 60m	840	60	m
1063288	9,9x1,1 120m	1680	120	m
1063381	9,9x1,1 480m	2880	480	m

Uponor Minitec tube protection joint

 1005269	9,9mm 300x2mm	3600	30	pièce
--	---------------	------	----	-------

Uponor Vario adaptateur pour collecteur Minitec

 1005266	9,9x1,1-G $\frac{3}{4}$ "Euro	100	10	pièce
--	-------------------------------	-----	----	-------

Uponor Minitec manchon avec bagues

 1005264	9,9x1,1	100	10	pièce
--	---------	-----	----	-------

Uponor Minitec raccord mâle

 1005265	9,9-R $\frac{1}{2}$ "MT	100	10	pièce
--	-------------------------	-----	----	-------

Uponor Minitec bague, coloris naturel

 1005263	9,9x1,1	1600	10	pièce
--	---------	------	----	-------

Uponor Minitec Raccord à compression

 1013426	9,9- $\frac{3}{4}$ "Euro	120	12	pièce
--	--------------------------	-----	----	-------

Uponor Fluvia adaptateur à visser en Y

 1005675	2xG $\frac{3}{4}$ - $\frac{3}{4}$ "Euro	50	1	jeu
--	---	----	---	-----

N° art.	Dimension	UL	UE	unité
---------	-----------	----	----	-------

Uponor Fluvia T groupe de pompe Push-12 AC-G

 1095128		60	1	pièce
--	--	----	---	-------

Uponor Vario vanne remplissage/vidange

 1061802	$\frac{3}{4}$ " - $\frac{3}{4}$ "	10	1	jeu
--	-----------------------------------	----	---	-----

Uponor Multi Coude de guidage de tuyau

 NEW 1135490	10-12	360	60	pièce
---	-------	-----	----	-------

Uponor Minitec boîte de connexion

 1005270	1X	30	1	pièce
1005271	2X	-	1	pièce
1005272	3X	-	1	pièce

Il faut procéder à l'exécution d'un réglage préalable pour s'assurer du respect de la température nominale

Uponor Minitec couvercle boîte connexion

 1007251		-	1	pièce
---	--	---	---	-------

Uponor Base thermostat standard T-23

 1058422	230V RAL9010	160	1	pièce
--	--------------	-----	---	-------

Uponor Minitec outil d'expansion

 1006247	9,9x1,1	11	1	jeu
--	---------	----	---	-----

Uponor Q&E outil d'expansion avec tête M12

 OUT 1063112	6BAR 9,9/20	-	1	jeu
---	-------------	---	---	-----

OUT Livraison dans la limite des stocks disponibles.
L'article expire au cours de l'année.

Uponor Q&E Outil d'évasement avec évasement c. M12/

 NEW 1119375	6bar 9,9RS/20	-	1	jeu
---	---------------	---	---	-----

Uponor Tecto

N° art.	Dimension	UL	UE	unité
---------	-----------	----	----	-------

Uponor Tecto plaque à plots

 1005478	EPS DES 30-2mm 14-17mm 1450x850mm	53,76	8,96	m ²
1005477	EPS 11mm 14-17mm 1450x850mm	94,08	15,68	m ²

Uponor Tecto fixation de tube diagonale

 1005482	45 75mm	420	10	pièce
--	---------	-----	----	-------

Uponor Tecto bande de jumelage, film

 1005484	1,4m 100mm	742,5	33,75	m
--	------------	-------	-------	---

Uponor Tecto élément d'expansion film

 1005481	1,45m 200mm	504	28	m
--	-------------	-----	----	---

Uponor Tecto élément d'expansion

 1005480	EPS DES 30-2mm 150x1400mm	268,8	8,4	m
1005479	EPS 11mm 150x1400mm	716,8	22,4	m

Uponor Multi bande périphérique

 1000079	150x8mm	-	200	m
--	---------	---	-----	---

Uponor Multi ruban périph. bav. autocol.

 1000080	150x10mm	-	200	m
--	----------	---	-----	---

Uponor Multi profilé pour joint PP

 1090229	1800x100x10mm	720	18	m
--	---------------	-----	----	---

Uponor Multi tube de protection de joint

 1000082	20mm 300x5mm	10800	30	pièce
--	--------------	-------	----	-------

N° art.	Dimension	UL	UE	unité
---------	-----------	----	----	-------

Uponor Comfort Pipe PLUS Blue tube

 1126541	16x2,0 640 m	640	640	m
--	--------------	-----	-----	---

Uponor Comfort Pipe PLUS tube

 1062883	14x2,0 120m	1320	120	m
1062884	14x2,0 240m	1680	240	m
1088166	14x2,0 640m	1920	640	m
1062885	14x2,0 960m	1920	960	m
1062044	16x2,0 120m	1080	120	m
1062045	16x2,0 240m	1440	240	m
1062046	16x2,0 640m	1280	640	m
1034535	17x2,0 120m	840	120	m
1009226	17x2,0 240m	1200	240	m
1086340	17x2,0 480m	960	480	m
1009227	17x2,0 640m	1280	640	m

Uponor Vario raccord de compression PEX

 1065283	14x2,0-G $\frac{3}{4}$ "FT Euro	25	1	pièce
1065284	16x1,8/2,0-G $\frac{3}{4}$ "FT Euro	25	1	pièce
1065286	17x2,0-G $\frac{3}{4}$ "FT Euro	25	1	pièce

Uponor Fit couplage de compression PEX

 1065296	16x1,8/2,0-16x1,8/2,0	25	1	pièce
1065299	17x2,0-17x2,0	25	1	pièce

Uponor Fit raccord trans à visser, ext. PEX

 1065294	14x2,0-R $\frac{1}{2}$ "MT	25	1	pièce
1065297	16x1,8/2,0-R $\frac{1}{2}$ "MT	25	1	pièce
1065300	17x2,0-R $\frac{1}{2}$ "MT	25	1	pièce

Uponor Fit raccord trans à visser, int. PEX

 1065295	14x2,0-Rp $\frac{1}{2}$ "FT	25	1	pièce
1065298	16x1,8/2,0-Rp $\frac{1}{2}$ "FT	25	1	pièce

Uponor Tecto

N° art.	Dimension	UL	UE	unité
---------	-----------	----	----	-------

Uponor Rapex manchon

 1005079	17-17	100	10	pièce
--	-------	-----	----	-------

Pour la réalisation du raccord à sertir, appliquer les Mâchoire de sertissage Uponor suivante (voir outillage Uponor):

Mâchoire de sertissage Uponor pour 17 x 2 mm PER-X numéro d'article 1006343

Uponor Q&E manchon avec bagues DR

 1058659	14-14	100	10	pièce
1058660	16x1,8/2,0-16x1,8/2,0	100	10	pièce
1058661	17-17	100	10	pièce

Uponor Q&E bague natural, eval

 1058428	14	900	20	pièce
--	----	-----	----	-------

Uponor Smart manchon égal à sertir

 1089646	14x2,0-14x2,0	80	20	pièce
1089647	16x1,8/2,0-16x1,8/2,0	80	20	pièce

Remarque : Sertissage avec la mâchoire à sertir S-Press Uponor

N° art.	Dimension	UL	UE	unité
---------	-----------	----	----	-------

Uponor MLCP RED tube

 1096010	14x1,6 240m	3120	240	m
1096011	14x1,6 480m	3360	480	m
1096012	16x2,0 240m	3120	240	m
1096013	16x2,0 480m	3360	480	m

Uponor Vario adaptateur à visser MLCP RED

 1000117	14x1,6-3/4" Euro	80	20	pièce
--	------------------	----	----	-------

Uponor MLCP RED raccord à sertir

 1048272	14x1,6-14x1,6	80	20	pièce
--	---------------	----	----	-------

Uponor S-Press PLUS manchon à sertir

 1070547	16-16	80	20	pièce
--	-------	----	----	-------

Uponor S-Press PLUS manchon à sertir PPSU

 1039933	16-16	80	20	pièce
--	-------	----	----	-------

Uponor Uni-X raccord à compression MLC

 1058090	16-3/4" FT Euro	25	1	pièce
--	-----------------	----	---	-------

Uponor Multi Coude de guidage de tuyau

 NEW 1135490	10-12	360	60	pièce
--	-------	-----	----	-------

Uponor Nubos

N° art.	Dimension	UL	UE	unité
---------	-----------	----	----	-------

Uponor Nubos plaque

 1016699	EPS 30-2 14-16mm 1447x900x48mm	60	10	m ²
1016700	EPS 11 14-16mm 1447x900x29mm	100	10	m ²

Uponor Nubos film

 1016703	14-16mm	140	10	m ²
1061880	14-16mm	-	200	m ²

Uponor Nubos ensemble

 1016701	EPS 30-2 14-16mm 1447x900x48mm	50	5	m ²
1016702	EPS 11 14-16mm 1447x900x29mm	50	5	m ²

Uponor Multi bande périphérique

 1000079	150x8mm	-	200	m
--	---------	---	-----	---

Uponor Multi ruban périph. bav. autocol.

 1000080	150x10mm	-	200	m
--	----------	---	-----	---

Uponor Multi profilé pour joint PP

 1090229	1800x100x10mm	720	18	m
--	---------------	-----	----	---

Uponor Multi tube de protection de joint

 1000082	20mm 300x5mm	10800	30	pièce
--	--------------	-------	----	-------

Uponor Fix Barre de serrage avec bande adhésive

 NEW 1135496	16-20mm c/c 50mm 1m	2000	100	pièce
--	------------------------	------	-----	-------

Uponor Comfort Pipe PLUS Blue tube

 1126541	16x2,0 640 m	640	640	m
--	--------------	-----	-----	---



Uponor Comfort Pipe PLUS tube

 1062883	14x2,0 120m	1320	120	m
1062884	14x2,0 240m	1680	240	m
1088166	14x2,0 640m	1920	640	m
1062885	14x2,0 960m	1920	960	m
1062044	16x2,0 120m	1080	120	m
1062045	16x2,0 240m	1440	240	m
1062046	16x2,0 640m	1280	640	m

N° art.	Dimension	UL	UE	unité
---------	-----------	----	----	-------

Uponor Vario raccord de compression PEX

 1065283	14x2,0-G $\frac{3}{4}$ "FT Euro	25	1	pièce
1065284	16x1,8/2,0-G $\frac{3}{4}$ "FT Euro	25	1	pièce

Uponor Fit couplage de compression PEX

 1065296	16x1,8/2,0-16x1,8/2,0	25	1	pièce
--	-----------------------	----	---	-------

Uponor Fit raccord trans à visser, int. PEX

 1065298	16x1,8/2,0-Rp $\frac{1}{2}$ "FT	25	1	pièce
--	---------------------------------	----	---	-------

Uponor Q&E manchon avec bagues DR

 1058660	16x1,8/2,0-16x1,8/2,0	100	10	pièce
--	-----------------------	-----	----	-------

Uponor Smart manchon égal à sertir

 1089646	14x2,0-14x2,0	80	20	pièce
1089647	16x1,8/2,0-16x1,8/2,0	80	20	pièce

Remarque : Sertissage avec la mâchoire à sertir S-Press Uponor

Uponor MLCP RED tube

 1096010	14x1,6 240m	3120	240	m
1096011	14x1,6 480m	3360	480	m
1096012	16x2,0 240m	3120	240	m
1096013	16x2,0 480m	3360	480	m

Uponor Vario adaptateur à visser MLCP RED

 1000117	14x1,6- $\frac{3}{4}$ "Euro	80	20	pièce
--	-----------------------------	----	----	-------

Uponor MLCP RED raccord à sertir

 1048272	14x1,6-14x1,6	80	20	pièce
--	---------------	----	----	-------

Uponor Uni-X raccord à compression MLC

 1058090	16- $\frac{3}{4}$ "FT Euro	25	1	pièce
--	----------------------------	----	---	-------

Uponor S-Press PLUS manchon

 1070547	16-16	80	20	pièce
--	-------	----	----	-------

Uponor S-Press PLUS manchon PPSU

 1039933	16-16	80	20	pièce
--	-------	----	----	-------

Uponor Multi Coude de guidage de tuyau

 NEW 1135491	14-18	240	30	pièce
--	-------	-----	----	-------

Uponor Klett

N° art.	Dimension	UL	UE	unité
---------	-----------	----	----	-------

Uponor Klett plaque en rouleau extra

 1063402	EPS DES 25-2mm 10x1m	80	10	m ²
1063322	EPS DES 30-2mm 10x1m	80	10	m ²
1063323	EPS DES 30-3mm 10x1m	80	10	m ²
1063324	EPS DES 35-3mm 10x1m	70	10	m ²

Uponor Klett Twinboard - double panneau

 1086854	2400x1000x3mm	360	24	m ²
--	---------------	-----	----	----------------

Uponor Klett panneau Silent

 1088065	1200x1000x30mm	48	4,8	m ²
--	----------------	----	-----	----------------

Uponor Multi bande périphérique

 1000079	150x8mm	-	200	m
--	---------	---	-----	---

Uponor Multi ruban périph. bav. autocol.

 1000080	150x10mm	-	200	m
--	----------	---	-----	---

Uponor Klett ruban périphérique

 1089919	1200x120x13mm	1536	96	m
--	---------------	------	----	---

Uponor Klett film d'étanchéité, autoadh.

 1089951	50m 280x0,2mm	6000	50	m
--	---------------	------	----	---

Uponor Multi profilé pour joint PP

 1090229	1800x100x10mm	720	18	m
--	---------------	-----	----	---

Uponor Multi tube de protection de joint

 1000082	20mm 300x5mm	10800	30	pièce
--	--------------	-------	----	-------

N° art.	Dimension	UL	UE	unité
---------	-----------	----	----	-------

Uponor Klett tube Comfort Pipe PLUS

 1088479	14x2,0 240m	1440	240	m
1088480	14x2,0 640m	1280	640	m
1087302	16x2,0 240m	1200	240	m
1087303	16x2,0 640m	1280	640	m

Uponor Vario raccord de compression PEX

 1065283	14x2,0-G $\frac{3}{4}$ "FT Euro	25	1	pièce
1065284	16x1,8/2,0-G $\frac{3}{4}$ "FT Euro	25	1	pièce

Uponor Smart manchon égal à sertir

 1089646	14x2,0-14x2,0	80	20	pièce
1089647	16x1,8/2,0-16x1,8/2,0	80	20	pièce

Remarque : Sertissage avec la mâchoire à sertir S-Press Uponor

Uponor Fit couplage de compression PEX

 1065296	16x1,8/2,0-16x1,8/2,0	25	1	pièce
--	-----------------------	----	---	-------

Uponor Fit raccord trans à visser, ext. PEX

 1065294	14x2,0-R $\frac{1}{2}$ "MT	25	1	pièce
1065297	16x1,8/2,0-R $\frac{1}{2}$ "MT	25	1	pièce

Uponor Fit raccord trans à visser, int. PEX

 1065295	14x2,0-Rp $\frac{1}{2}$ "FT	25	1	pièce
1065298	16x1,8/2,0-Rp $\frac{1}{2}$ "FT	25	1	pièce

Uponor Q&E manchon avec bagues DR

 1058659	14-14	100	10	pièce
1058660	16x1,8/2,0-16x1,8/2,0	100	10	pièce

Uponor Q&E bague naturel, eval

 1058428	14	900	20	pièce
--	----	-----	----	-------

Uponor Q&E bague évolution white

 1057453	16	900	20	pièce
--	----	-----	----	-------

Uponor Klett

N° art.	Dimension	UL	UE	unité
---------	-----------	----	----	-------

Uponor Klett MLCP tube rouge

 1096014	16X2,0 240M	1920	240	m
1096015	16X2,0 480M	2400	480	m

Uponor Uni-X raccord à compression MLC

 1058090	16-3/4"FT Euro	25	1	pièce
--	----------------	----	---	-------

Uponor S-Press PLUS manchon à sertir

 1070547	16-16	80	20	pièce
--	-------	----	----	-------

Uponor S-Press PLUS manchon à sertir PPSU

 1039933	16-16	80	20	pièce
--	-------	----	----	-------

N° art.	Dimension	UL	UE	unité
---------	-----------	----	----	-------

Uponor Multi rouleau de ruban adhésif

 1000012	66m 50mm	36	1	pièce
--	----------	----	---	-------

Uponor Multi rouleau de ruban adhésif

 1000142		20	1	pièce
--	--	----	---	-------

Uponor Multi Coude de guidage de tuyau

 NEW 1135491	14-18	240	30	pièce
--	-------	-----	----	-------

Uponor Multi support de tube

 1088066		-	1	pièce
---	--	---	---	-------

Uponor Tacker

N° art.	Dimension	UL	UE	unité
---------	-----------	----	----	-------

Uponor Tacker rouleau

 1090921	EPS DES 20-2mm 10x1m	100	10	m ²
1090924	EPS DES 30-2mm 10x1m	80	10	m ²
1090925	EPS DES 30-3mm 10x1m	80	10	m ²
1090926	EPS DES 35-3mm 10x1m	70	10	m ²
1090927	EPS DES 40-3mm 10x1m	60	10	m ²

Uponor Tacker panneau

 1090917	EPS DEO 20	100	10	m ²
1090918	EPS DEO 30	80	10	m ²

Uponor Tacker Film transparent

 1122372	0,2mm 100x1,03m	2884	103	m ²
--	-----------------	------	-----	----------------

Uponor Multi bande périphérique

 1000079	150x8mm	-	200	m
---	---------	---	-----	---

Uponor Multi ruban périph. bav. autocol.

 1000080	150x10mm	-	200	m
--	----------	---	-----	---

Uponor Multi profilé pour joint PP

 1090229	1800x100x10mm	720	18	m
--	---------------	-----	----	---

Uponor Multi tube de protection de joint

 1000082	20mm 300x5mm	10800	30	pièce
--	--------------	-------	----	-------

Uponor Multi rouleau de ruban adhésif



 1000012	66m 50mm	36	1	pièce
--	----------	----	---	-------

Uponor Multi rouleau de ruban adhésif

 1000142		20	1	pièce
--	--	----	---	-------

N° art.	Dimension	UL	UE	unité
---------	-----------	----	----	-------

Uponor Comfort Pipe PLUS Blue tube

 1126541	16x2,0 640 m	640	640	m
 1126542	20x2,0 480 m	480	480	m



Uponor Comfort Pipe PLUS tube

 1062883	14x2,0 120m	1320	120	m
1062884	14x2,0 240m	1680	240	m
1088166	14x2,0 640m	1920	640	m
1062885	14x2,0 960m	1920	960	m
1062044	16x2,0 120m	1080	120	m
1062045	16x2,0 240m	1440	240	m
1062046	16x2,0 640m	1280	640	m
1034535	17x2,0 120m	840	120	m
1009226	17x2,0 240m	1200	240	m
1009227	17x2,0 640m	1280	640	m

Uponor Magna pipe PLUS

 1091275	20x2,0 240m	960	240	m
1091276	20x2,0 480m	960	480	m

Uponor Vario raccord de compression PEX

 1065283	14x2,0-G ³ / ₄ "FT Euro	25	1	pièce
1065284	16x1,8/2,0-G ³ / ₄ "FT Euro	25	1	pièce
1065286	17x2,0-G ³ / ₄ "FT Euro	25	1	pièce
1065290	20x1,9/2,0-G ³ / ₄ "FT Euro	25	1	pièce

Uponor Fit couplage de compression PEX

 1065296	16x1,8/2,0-16x1,8/2,0	25	1	pièce
1065299	17x2,0-17x2,0	25	1	pièce
1065302	20x1,9/2,0-20x1,9/2,0	25	1	pièce

Uponor Smart manchon égal à sertir

 1089646	14x2,0-14x2,0	80	20	pièce
1089647	16x1,8/2,0-16x1,8/2,0	80	20	pièce

Remarque : Sertissage avec la mâchoire à sertir S-Press Uponor

Uponor Fit raccord trans à visser, ext. PEX

 1065294	14x2,0-R ¹ / ₂ "MT	25	1	pièce
1065297	16x1,8/2,0-R ¹ / ₂ "MT	25	1	pièce
1065300	17x2,0-R ¹ / ₂ "MT	25	1	pièce
1065305	20x1,9/2,0-R ³ / ₄ "MT	25	1	pièce

Uponor Tacker

N° art.	Dimension	UL	UE	unité
---------	-----------	----	----	-------

Uponor Fit raccord trans à visser, int. PEX

 1065295	14x2,0-Rp½"FT	25	1	pièce
1065298	16x1,8/2,0-Rp½"FT	25	1	pièce
1065306	20x1,9/2,0-Rp¾"FT	25	1	pièce

Uponor Rapex manchon

 1005079	17-17	100	10	pièce
--	-------	-----	----	-------

Pour la réalisation du raccord à sertir, appliquer les Mâchoire de sertissage Uponor suivante (voir outillage Uponor)

Mâchoire de sertissage Uponor pour 17 x 2 mm PEX numéro d'article 1006343

Uponor Q&E manchon avec bagues DR

 1058660	16x1,8/2,0-16x1,8/2,0	100	10	pièce
1058661	17-17	100	10	pièce

Uponor MLCP RED tube

 1096010	14x1,6 240m	3120	240	m
1096011	14x1,6 480m	3360	480	m
1096012	16x2,0 240m	3120	240	m
1096013	16x2,0 480m	3360	480	m

Uponor Vario adaptateur à visser MLCP RED

 1000117	14x1,6-¾"Euro	80	20	pièce
--	---------------	----	----	-------

Uponor MLCP RED raccord à sertir

 1048272	14x1,6-14x1,6	80	20	pièce
--	---------------	----	----	-------

Uponor Uni-X raccord à compression MLC

 1058090	16-¾"FT Euro	25	1	pièce
--	--------------	----	---	-------

Uponor S-Press PLUS manchon à sertir

 1070547	16-16	80	20	pièce
--	-------	----	----	-------

Uponor S-Press PLUS manchon à sertir PPSU

 1039933	16-16	80	20	pièce
--	-------	----	----	-------

N° art.	Dimension	UL	UE	unité
---------	-----------	----	----	-------

Uponor Tacker Agrafeuse courte

 NEW 1135487	14-17mm h=35mm	8400	300	pièce
---	-------------------	------	-----	-------

Uponor Tacker agrafe stan. tube Tacker

 1086529	14-20mm h=40mm	75000	1000	pièce
--	----------------	-------	------	-------

Uponor Tacker agrafe longue tube Tacker

 NEW 1135489	14-20mm h=50mm	5000	250	pièce
---	-------------------	------	-----	-------

Uponor Tacker outil

 1119039	14-20mm	50	1	pièce
---	---------	----	---	-------

Uponor Multi Coude de guidage de tuyau

 NEW 1135491	14-18	240	30	pièce
NEW 1135492	20-22	140	35	pièce

Uponor Fix

N° art.	Dimension	UL	UE	unité
---------	-----------	----	----	-------

Uponor Fix Barre de serrage avec bande adhésive

 NEW 1135496	16-20mm c/c 50mm 1m	2000	100	pièce
--	------------------------	------	-----	-------

Uponor Fix Bornier

 1005498	14mm c/c50mm 2,5m	-	25	m
---	-------------------	---	----	---

Uponor Fix Bornier

 1005274	9,9mm c/c20mm 2,5m	25	2,5	m
---	--------------------	----	-----	---

Uponor Comfort Pipe PLUS tube

 1062883	14x2,0 120m	1320	120	m
1062884	14x2,0 240m	1680	240	m
1062885	14x2,0 960m	1920	960	m
1009229	20x2,0 60m	660	60	m

Uponor Minitec tube Comfort Pipe

 1063287	9,9x1,1 60m	840	60	m
1063288	9,9x1,1 120m	1680	120	m
1063381	9,9x1,1 480m	2880	480	m

Uponor Magna pipe PLUS

 1091275	20x2,0 240m	960	240	m
1091276	20x2,0 480m	480		m

Uponor Vario raccord de compression PEX

 1065283	14x2,0-G $\frac{3}{4}$ "FT Euro	25	1	pièce
1065290	20x1,9/2,0-G $\frac{3}{4}$ "FT Euro	25	1	pièce

Uponor Smart manchon égal à sertir

 1089646	14x2,0-14x2,0	80	20	pièce
---	---------------	----	----	-------

Remarque : Sertissage avec la mâchoire à sertir S-Press Uponor

Uponor Fit raccord trans à visser, ext. PEX

 1065294	14x2,0-R $\frac{1}{2}$ "MT	25	1	pièce
---	----------------------------	----	---	-------

Uponor Fit raccord trans à visser, int. PEX

 1065295	14x2,0-Rp $\frac{1}{2}$ "FT	25	1	pièce
---	-----------------------------	----	---	-------

Uponor Q&E manchon avec bagues DR

 1058659	14-14	100	10	pièce
---	-------	-----	----	-------

Uponor Q&E bague natural, eval

 1058428	14	900	20	pièce
---	----	-----	----	-------

Uponor Q&E bague évolution white

 1057454	20	520	20	pièce
---	----	-----	----	-------

N° art.	Dimension	UL	UE	unité
---------	-----------	----	----	-------

Uponor MLCP RED tube

 1096010	14x1,6 240m	3120	240	m
1096011	14x1,6 480m	3360	480	m

Uponor Vario adaptateur à visser MLCP RED

 1000117	14x1,6- $\frac{3}{4}$ "Euro	80	20	pièce
---	-----------------------------	----	----	-------

Uponor MLCP RED raccord à sertir

 1048272	14x1,6-14x1,6	80	20	pièce
---	---------------	----	----	-------

Uponor Minitec bague naturel

 1005263	9,9x1,1	1600	10	pièce
---	---------	------	----	-------

Uponor Vario adaptateur pour collecteur Minitec

 1005266	9,9x1,1-G $\frac{3}{4}$ "Euro	100	10	pièce
---	-------------------------------	-----	----	-------

Uponor Minitec manchon avec bagues

 1005264	9,9x1,1	100	10	pièce
--	---------	-----	----	-------

Uponor Minitec Té réduit, bague Q&E

 1020524	20xMinitec9,9xQ&E20	75	5	pièce
---	---------------------	----	---	-------

Uponor Minitec raccord mâle

 1005265	9,9-R $\frac{1}{2}$ "MT	100	10	pièce
---	-------------------------	-----	----	-------

Uponor Minitec manchon réduit Q&E

 1020518	20xMinitec9,9	150	5	pièce
---	---------------	-----	---	-------

Uponor Minitec Raccord à compression

 1013426	9,9- $\frac{3}{4}$ "Euro	120	12	pièce
---	--------------------------	-----	----	-------

Uponor Minitec outil d'expansion

 1006247	9,9x1,1	11	1	jeu
---	---------	----	---	-----

Uponor Q&E outil d'expansion avec tête M12

 1119375	6bar 9,9RS/20	-	1	jeu
---	---------------	---	---	-----

Uponor Multi Coude de guidage de tuyau

 NEW 1135490	10-12	360	60	pièce
NEW 1135491	14-18	240	30	pièce
NEW 1135492	20-22	140	35	pièce

Uponor Classic

N° art.	Dimension	UL	UE	unité
---------	-----------	----	----	-------

Uponor Classic treillis enrobé

 1005084	100mm 2100x1200x3mm	750	25	m ²
1005087	150mm 2100x1200x3mm	750	25	m ²

Uponor Classic fil lien, acier, revêtu

 1007393	80mm (100pce/set)	2500	50	jeu
--	-------------------	------	----	-----

Uponor Classic attache maîtresse, treillis métallique

 1005188	16mm 3mm	500	500	pièce
1005189	17mm 3mm	500	500	pièce
1005190	20mm 3mm	2800	280	pièce

Uponor Multi bande périphérique

 1000079	150x8mm	-	200	m
--	---------	---	-----	---

Uponor Multi ruban périph. bav. autocol.

 1000080	150x10mm	-	200	m
--	----------	---	-----	---

Uponor Multi profilé pour joint PP



 1090229	1800x100x10mm	720	18	m
--	---------------	-----	----	---

Uponor Multi tube de protection de joint

 1000082	20mm 300x5mm	10800	30	pièce
--	--------------	-------	----	-------

Uponor Comfort Pipe PLUS Blue tube



 1126541	16x2,0 640 m	640	640	m
 1126542	20x2,0 480 m	480	480	m

Uponor Comfort Pipe PLUS tube

 1062044	16x2,0 120m	1080	120	m
1062045	16x2,0 240m	1440	240	m
1062046	16x2,0 640m	1280	640	m
1034535	17x2,0 120m	840	120	m
1009226	17x2,0 240m	1200	240	m
1086340	17x2,0 480m	960	480	m
1009227	17x2,0 640m	1280	640	m

Uponor Magna pipe PLUS

 1091275	20x2,0 240m	960	240	m
1091276	20x2,0 480m	960	480	m

Uponor Vario raccord de compression PEX

 1065284	16x1,8/2,0-G $\frac{3}{4}$ "FT Euro	25	1	pièce
1065286	17x2,0-G $\frac{3}{4}$ "FT Euro	25	1	pièce
1065290	20x1,9/2,0-G $\frac{3}{4}$ "FT Euro	25	1	pièce

N° art.	Dimension	UL	UE	unité
---------	-----------	----	----	-------

Uponor Fit couplage de compression PEX

 1065296	16x1,8/2,0-16x1,8/2,0	25	1	pièce
1065299	17x2,0-17x2,0	25	1	pièce
1065302	20x1,9/2,0-20x1,9/2,0	25	1	pièce

Uponor Smart manchon égal à sertir

 1089647	16x1,8/2,0-16x1,8/2,0	80	20	pièce
1089648	20x2,0-20x2,0	80	20	pièce

Remarque : Sertissage avec la mâchoire à sertir S-Press Uponor

Uponor Fit raccord trans à visser, ext. PEX

 1065297	16x1,8/2,0-R $\frac{1}{2}$ "MT	25	1	pièce
1065300	17x2,0-R $\frac{1}{2}$ "MT	25	1	pièce
1065305	20x1,9/2,0-R $\frac{3}{4}$ "MT	25	1	pièce

Uponor Fit raccord trans à visser, int. PEX

 1065298	16x1,8/2,0-Rp $\frac{1}{2}$ "FT	25	1	pièce
1065306	20x1,9/2,0-Rp $\frac{3}{4}$ "FT	25	1	pièce

Uponor Rapex manchon

 1005079	17-17	100	10	pièce
--	-------	-----	----	-------

Pour la réalisation du raccord à sertir, appliquer les Mâchoire de sertissage Uponor suivante (voir outillage Uponor):

Mâchoire de sertissage Uponor pour 17 x 2 mm PER-X numéro d'article 1006343

Uponor Q&E manchon avec bagues DR

 1058660	16x1,8/2,0-16x1,8/2,0	100	10	pièce
1058661	17-17	100	10	pièce
1058668	20-20	80	10	pièce

Uponor Multi Coude de guidage de tuyau

 NEW 1135491	14-18	240	30	pièce
NEW 1135492	20-22	140	35	pièce

Uponor Classic Clipmaster

 1006295	16/17mm l=920mm	100	1	pièce
1006309	20mm l=920mm	-	1	pièce

Uponor Classic outil tordage

 1006243	l=320mm	50	1	pièce
--	---------	----	---	-------

Uponor Siccus 14

N° art.	Dimension	UL	UE	unité
---------	-----------	----	----	-------

Uponor Siccus 14 panneau

 1005485	EPS 150kPa 14mm 1197x1050x25mm	100	12,5	m ²
--	-----------------------------------	-----	------	----------------

Uponor Siccus 14 lamelle thermo-conduct.

 1005486	14mm 1180x120x0,45mm	768	48	pièce
--	-------------------------	-----	----	-------

Uponor Multi bande périphérique

 1000079	150x8mm	-	200	m
--	---------	---	-----	---

Uponor Comfort Pipe PLUS tube

 1062883	14x2,0 120m	1320	120	m
1062884	14x2,0 240m	1680	240	m
1088166	14x2,0 640m	1920	640	m
1062885	14x2,0 960m	1920	960	m

Uponor Vario raccord de compression PEX

 1065283	14x2,0-G $\frac{3}{4}$ "FT Euro	25	1	pièce
--	---------------------------------	----	---	-------

Uponor Fit raccord trans à visser, ext. PEX

 1065294	14x2,0-R $\frac{1}{2}$ "MT	25	1	pièce
--	----------------------------	----	---	-------

Uponor Fit raccord trans à visser, int. PEX

 1065295	14x2,0-Rp $\frac{1}{2}$ "FT	25	1	pièce
--	-----------------------------	----	---	-------

Uponor Q&E manchon avec bagues DR

 1058659	14-14	100	10	pièce
--	-------	-----	----	-------

Uponor Q&E bague natural, eval

 1058428	14	900	20	pièce
--	----	-----	----	-------

Uponor Smart manchon égal à sertir

 1089646	14x2,0-14x2,0	80	20	pièce
--	---------------	----	----	-------

Remarque: Sertissage avec la mâchoire à sertir S-Press Uponor

N° art.	Dimension	UL	UE	unité
---------	-----------	----	----	-------

Uponor MLCP RED tube

 1096010	14x1,6 240m	3120	240	m
1096011	14x1,6 480m	3360	480	m

Uponor Vario adaptateur à visser MLCP RED

 1000117	14x1,6- $\frac{3}{4}$ "Euro	80	20	pièce
--	-----------------------------	----	----	-------

Uponor MLCP RED raccord à sertir

 1048272	14x1,6-14x1,6	80	20	pièce
--	---------------	----	----	-------

Uponor Multi Coude de guidage de tuyau

 NEW 1135491	14-18	240	30	pièce
---	-------	-----	----	-------

Uponor Siccus 14 cutter à polystyrène

 1006290	14mm 230V	20	1	pièce
--	-----------	----	---	-------

Uponor Renovis

N° art.	Dimension	UL	UE	unité
---------	-----------	----	----	-------

Uponor Renovis panneau

 1061173	800x625mm	-	24	pièce
1061172	1200x625mm	-	24	pièce
1061171	2000x625mm	-	24	pièce

Uponor Renovis panneau extra

 1063923	800x625x15mm	24	1	pièce
1063924	1200x625x15mm	24	1	pièce
1063925	2000x625x15mm	24	1	pièce

Uponor Renovis panneau passif

 1063926	2000x625x15mm	-	24	pièce
--	---------------	---	----	-------

Uponor Renovis kit de composants

 1061165	4-6X	10	1	jeu
--	------	----	---	-----

Ter informatie: de in de omschrijving genoemde „4-6 loop“ betekend: 4-6 groepen

Uponor Fix Bornier

 1005274	9,9mm c/c20mm 2,5m	25	2,5	m
--	--------------------	----	-----	---

Uponor Renovis rail de fixation

 1061162	20mm l=250mm	-	15	pièce
--	--------------	---	----	-------

Uponor Minitec tube Comfort Pipe

 1063287	9,9x1,1 60m	840	60	m
1063288	9,9x1,1 120m	1680	120	m

Uponor Minitec raccord mâle

 1005265	9,9-R $\frac{1}{2}$ MT	100	10	pièce
--	------------------------	-----	----	-------

Uponor Minitec manchon avec bagues

 1005264	9,9x1,1	100	10	pièce
--	---------	-----	----	-------

Uponor Minitec bague, coloris naturel

 1005263	9,9x1,1	1600	10	pièce
--	---------	------	----	-------

N° art.	Dimension	UL	UE	unité
---------	-----------	----	----	-------

Uponor Comfort Pipe PLUS tube

 1009229	20x2,0 60m	660	60	m
--	------------	-----	----	---

Uponor Magna pipe PLUS

 1091275	20x2,0 240m	960	240	m
1091276	20x2,0 480m	960	480	m

Uponor Minitec Té réduit, bague Q&E

 1020524	20xMinitec9,9xQ&E20	75	5	pièce
--	---------------------	----	---	-------

Uponor Minitec manchon réduit Q&E

 1020518	20xMinitec9,9	150	5	pièce
--	---------------	-----	---	-------

Uponor Q&E manchon PPSU

 1008932	20-20	80	5	pièce
---	-------	----	---	-------

Uponor Q&E coude PPSU

 1008680	20-20	40	5	pièce
--	-------	----	---	-------

Uponor Q&E bague évolution white

 1057454	20	520	20	pièce
--	----	-----	----	-------

Uponor Renovis

N° art.	Dimension	UL	UE	unité
---------	-----------	----	----	-------

Uponor Uni Pipe PLUS tube nu en barre S

 1060784	20x2,25 3m	51	3	m
--	------------	----	---	---

Uponor Q&E adaptateur en T S-Press

 1063938	20-Q&E9,9-Press20	6	2	pièce
--	-------------------	---	---	-------

Uponor Q&E adaptateur S-Press

 1063939	20-Q&E9,9	12	2	pièce
--	-----------	----	---	-------

Uponor Vario vanne de réglage fin

 1005107	½" - G¾	50	1	pièce
--	---------	----	---	-------

Uponor Vario vanne de fermeture retour

 1005108	½" - G¾	50	1	pièce
--	---------	----	---	-------

Uponor Vario PLUS moteur NC

 1005605	230V MT30x1,5	10	1	pièce
--	---------------	----	---	-------

Uponor Base thermostat standard T-23

 1058422	230V RAL9010	160	1	pièce
--	--------------	-----	---	-------

Uponor Minitec outil d'expansion

 1006247	9,9x1,1	11	1	jeu
--	---------	----	---	-----

Uponor Q&E outil d'expansion avec tête M12

 OUT 1063112	6BAR 9,9/20	-	1	jeu
---	-------------	---	---	-----

OUT Livraison dans la limite des stocks disponibles.
L'article expire au cours de l'année.

Uponor Q&E Outil d'évasement avec évasement c. M12/

 1119375	6bar 9,9RS/20	-	1	jeu
--	---------------	---	---	-----

Uponor Multi Coude de guidage de tuyau

 NEW 1135490	10-12	360	60	pièce
NEW 1135492	20-22	140	35	pièce

Uponor Comfort E

N° art.	Dimension	UL	UE	unité
---------	-----------	----	----	-------

Uponor Comfort E tapis de câble set T-87IF

 1088668	160-1	50	1	jeu
1088669	160-1,5	50	1	jeu
1088670	160-2	50	1	jeu
1088671	160-2,5	50	1	jeu
1088672	160-3	50	1	jeu
1088673	160-4	35	1	jeu
1088674	160-5	35	1	jeu
1088675	160-6	35	1	jeu
1088676	160-7	20	1	jeu
1088677	160-8	20	1	jeu
1088678	160-10	20	1	jeu
1088679	160-12	20	1	jeu

Uponor Comfort E tapis de câble

 1088656	160-1	50	1	jeu
1088657	160-1,5	50	1	jeu
1088658	160-2	50	1	jeu
1088659	160-2,5	50	1	jeu
1088660	160-3	50	1	jeu
1088661	160-4	35	1	jeu
1088662	160-5	35	1	jeu
1088663	160-6	35	1	jeu
1088664	160-7	20	1	jeu
1088665	160-8	20	1	jeu
1088666	160-10	20	1	jeu
1088667	160-12	20	1	jeu

Uponor Comfort E thermostat à cadran set T-85

 1088705	230V	-	1	jeu
--	------	---	---	-----

Uponor Comfort E thermostat dig. progr. flush Set T-86

 1088819	230V	-	1	jeu
--	------	---	---	-----

Uponor Comfort E thermostat dig. progr. flush Set T-87IF

 1088706	230V	-	1	jeu
--	------	---	---	-----

Uponor Comfort E capteur de sol T-85, T-87

 1090944		100	1	pièce
--	--	-----	---	-------

Uponor Siccus wall

N° art.	Dimension	UL	UE	unité
---------	-----------	----	----	-------

Uponor Siccus 14 panneau

 1005485	EPS 150kPa 14mm 1197x1050x25mm	100	12,5	m ²
--	-----------------------------------	-----	------	----------------

Uponor Siccus 14 lamelle thermo-conduct.

 1005486	14mm 1180x120x0,45mm	768	48	pièce
--	-------------------------	-----	----	-------

Uponor Comfort Pipe PLUS tube

 1062883	14x2,0 120m	1320	120	m
1062884	14x2,0 240m	1680	240	m
1062885	14x2,0 960m	1920	960	m

Uponor Vario raccord de compression PEX

 1065283	14x2,0-G $\frac{3}{4}$ "FT Euro	25	1	pièce
--	---------------------------------	----	---	-------

Uponor Fit raccord trans à visser, ext. PEX

 1065294	14x2,0-R $\frac{1}{2}$ "MT	25	1	pièce
--	----------------------------	----	---	-------

Uponor Fit raccord trans à visser, int. PEX

 1065295	14x2,0-Rp $\frac{1}{2}$ "FT	25	1	pièce
--	-----------------------------	----	---	-------

Uponor Q&E manchon avec bagues DR

 1058659	14-14	100	10	pièce
--	-------	-----	----	-------

Uponor Q&E bague natural, eval

 1058428	14	900	20	pièce
--	----	-----	----	-------

Uponor Smart manchon égal à sertir

 1089646	14x2,0-14x2,0	80	20	pièce
--	---------------	----	----	-------

Remarque: Sertissage avec la mâchoire à sertir S-Press Uponor

N° art.	Dimension	UL	UE	unité
---------	-----------	----	----	-------

Uponor MLCP RED tube

 1096010	14x1,6 240m	3120	240	m
1096011	14x1,6 480m	3360	480	m

Uponor Vario adaptateur à visser MLCP RED

 1000117	14x1,6- $\frac{3}{4}$ "Euro	80	20	pièce
--	-----------------------------	----	----	-------

Uponor MLCP RED raccord à sertir

 1048272	14x1,6-14x1,6	80	20	pièce
--	---------------	----	----	-------

Uponor Siccus 14 cutter à polystyrène

 1006290	14mm 230V	20	1	pièce
--	-----------	----	---	-------

Uponor Thermanatop

N° art.	Dimension	UL	UE	unité
---------	-----------	----	----	-------

Uponor Thermanatop M

 1090933	950x277mm	200	10	pièce
1090934	1350X277mm	200	10	pièce
1090935	1750X277mm	200	10	pièce
1090936	2150X277mm	200	10	pièce
1090937	2550x277mm	200	10	pièce

N° art.	Dimension	UL	UE	unité
---------	-----------	----	----	-------

Uponor Uni-X adaptateur à visser MLC

 1058090	16-3/4"FT Euro	25	1	pièce
--	----------------	----	---	-------

Uponor S-Press PLUS manchon à sertir

 1070547	16-16	80	10	pièce
--	-------	----	----	-------

Uponor S-Press PLUS manchon à sertir PPSU

 1039933	16-16	80	10	pièce
--	-------	----	----	-------



Uponor Multi

N° art.	Dimension	UL	UE	unité
---------	-----------	----	----	-------

Uponor Multi attaches de câble PA

	1005372	300mm	5000	100	pièce
---	----------------	-------	------	-----	-------

Uponor Multi attaches de câble PA

	1086531	200mm	10000	100	pièce
---	----------------	-------	-------	-----	-------

Uponor Multi profilé en U rail fixation

	1005358	20mm c/c50mm 3m	30	3	m
---	----------------	-----------------	----	---	---

Uponor Multi folio PE



	1005051	0,1mm 75x2m	6900	150	m ²
---	----------------	-------------	------	-----	----------------

Uponor Multi folio PE

	1005049	0,2mm 60x1,25m	3375	75	m ²
---	----------------	----------------	------	----	----------------

VEUILLEZ NOTER : vendu par unité d'emballage 1 rol (75 m²) = € 86,25

Uponor Multi folio texturé avec grille

	 1000015	0,25mm 100x1,03m	2472	103	m ²
---	--	---------------------	------	-----	----------------

 Livraison dans la limite des stocks disponibles.
L'article expire au cours de l'année.

Uponor Multi clou pour folio

	1000016	l=25mm	5000	100	pièce
---	----------------	--------	------	-----	-------

Uponor Multi ruban périph., auto-adhésif PE

	1013117	40m 100x10mm	-	240	m
	1000080	150x10mm	-	200	m

N° art.	Dimension	UL	UE	unité
---------	-----------	----	----	-------

Uponor Multi bande périphérique

	1000079	150x8mm	-	200	m
---	----------------	---------	---	-----	---

Uponor Multi profilé pour joint PP

	1090229	1800x100x10mm	720	18	m
---	----------------	---------------	-----	----	---

Uponor Multi tube de protection de joint

	1000082	20mm 300x5mm	10800	30	pièce
---	----------------	--------------	-------	----	-------

Uponor Multi additif pour chape VD 450

	1000084	20L	480	20	l
---	----------------	-----	-----	----	---

Remarque : protéger du gel et des rayons UV. Aucune reprise possible.

Uponor Multi additif chape, séch. rapide VD 550 N

	1000085	25L	600	25	l
--	----------------	-----	-----	----	---

Remarque : protéger du gel et des rayons UV. Aucune reprise possible.

Uponor Multi set de marquage

	1000083	100mm	-	10	pièce
---	----------------	-------	---	----	-------

Uponor Multi mat. remp. pour nivellement

	1000052	100l	2500	100	l
---	----------------	------	------	-----	---

VEUILLEZ NOTER : vendu par unité d'emballage

Uponor Multi additif antigel éthylène

	1005066	≥ -30 °C 20 l	480	20	l
---	----------------	---------------	-----	----	---

Conduites de distribution 25–75 mm

N° art.	Dimension	UL	UE	unité
---------	-----------	----	----	-------

Uponor Uni Pipe PLUS tube nu en barre S

 1060785	25x2,5 3m	30	3	m
1060786	32x3,0 3m	21	3	m

Uponor MLC tube, blanc S

 1013448	40x4,0 3m	12	3	m
1021980	50x4,5 3m	12	3	m
1021981	63x6,0 3m	9	3	m
1013453	75x7,5 5m	255	5	m

Uponor S-Press PLUS manchon PPSU

 1039935	25-25	80	10	pièce
1039936	32-32	80	10	pièce

Uponor S-Press manchon égal PPSU

 1046401	40-40	960	5	pièce
1046402	50-50	576	3	pièce
1032881	63-63	384	1	pièce
1032882	75-75	384	1	pièce

Uponor S-Press PLUS manchon réduit PPSU

 1039940	32-25	80	10	pièce
--	-------	----	----	-------

Uponor S-Press manchon réduit PPSU

 1039941	40-25	960	5	pièce
1039942	40-32	960	5	pièce
1039943	50-32	1152	3	pièce

Uponor S-Press manchon réduit PPSU

 1046406	50-40	576	3	pièce
1032883	63-40	384	1	pièce
1032884	63-50	384	1	pièce
1032885	75-50	384	1	pièce
1032886	75-63	384	1	pièce

Uponor S-Press PLUS coude PPSU

 1039931	25-25	80	10	pièce
1039932	32-32	20	5	pièce

Uponor S-Press coude PPSU

 1046386	40-40	960	5	pièce
1046387	50-50	576	3	pièce
1032877	63-63	210	1	pièce
1032878	75-75	210	1	pièce

Uponor S-Press coude 45° PPSU

 1046388	40-40	960	5	pièce
1046389	50-50	576	3	pièce
1032879	63-63	192	1	pièce
1032880	75-75	192	1	pièce

N° art.	Dimension	UL	UE	unité
---------	-----------	----	----	-------

Uponor S-Press PLUS T PPSU

 1039946	25-25-25	20	5	pièce
1039947	32-32-32	20	5	pièce

Uponor S-Press Té égal PPSU

 1046390	40-40-40	720	5	pièce
1046391	50-50-50	288	3	pièce
1032887	63-63-63	150	1	pièce
1032888	75-75-75	150	1	pièce

Uponor S-Press PLUS T filetage femelle

 1070598	25-Rp½"FT-25	20	5	pièce
1070600	32-Rp½"FT-32	20	5	pièce

Uponor S-Press té femelle

 1046922	40-Rp½"FT-40	500	5	pièce
1046929	50-Rp1"FT-50	240	3	pièce

Uponor S-Press PLUS raccord mâle

 1070507	25-R¾"MT	80	10	pièce
1070508	25-R1"MT	40	5	pièce
1070509	32-R1"MT	40	5	pièce
1070510	32-R1 ¼"MT	20	5	pièce

Uponor S-Press raccord mâle

 1046901	40-R1 ¼"MT	960	5	pièce
1046902	40-R1 ½"MT	960	5	pièce
1046905	50-R1 ½"MT	1152	3	pièce
1046906	50-R2"MT	576	3	pièce
1032895	63-R2"MT	336	1	pièce
1032896	75-R2 ½"MT	336	1	pièce















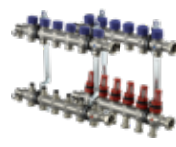

Uponor S-Press PLUS raccord femelle

 1070519	25-Rp¾"FT	40	5	pièce
1070520	25-Rp1"FT	40	5	pièce
1070521	32-Rp1"FT	40	5	pièce
1070522	32-Rp1 ¼"FT	20	5	pièce

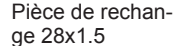
Uponor S-Press raccord femelle

 1046903	40-Rp1 ¼"FT	960	5	pièce
1046904	40-Rp1 ½"FT	960	5	pièce
1046907	50-Rp1 ½"FT	1152	3	pièce

Vue d'ensemble des actionneurs

Moteur		Geschikt voor verdeler			
Uponor Vario PLUS Moteur PRO MT 30x1,5 		Uponor Vario PLUS 	Uponor Magna Distributeur de chauffage industriel 	Uponor Vario Vanne de régulation 	Uponor Vario Vanne RL 
Description	N° art.				
24 V	1000138				
230 V	1005605				
Uponor Vario thermische aandrijving S 		Vario M avec débitmètre FM 			
Description	N° art.				
24 V	1087778				
230 V	1087763				
Uponor Vario S Moteur FT 30x1,5 		Vario S Distributeur en acier inoxydable ST FM 	Vario S Distributeur en acier inoxydable ST LS (jusqu'à 2018) 	Pièce de rechange Chronatherm	
Description	N° art.				
24 V	1020262				
230 V	1020261				
Uponor Vario B Moteur PRO FT 28x1,5 		Pièce de rechange Uponor Fluvia T 	Pièce de rechange Unipipe 	Pièce de rechange 28x1.5 	
Description	N° art.				
24 V	1007249				
230 V	1022244				
Uponor Vario PLUS Adapteur VA 02 30 x 1,5 AG 		Pièces de rechange Velta Kompakt et Velta Distributeur Euro 			
Description	N° art.				
24 V	1090262				
230 V	1090263				
Uponor Vario B Adapteur VA 32 28 x 1,5 IG 		Pièce de rechange Polytherm sans DF 	Pièce de rechange Polytherm DF 		
Description	N° art.				
24 V	1090264				
230 V	1090265				

Uponor Vario PLUS

N° art.	Dimension	UL	UE	unité
---------	-----------	----	----	-------

Uponor Vario PLUS Collecteur polyamide

 1042420	LS 1X ¾ Euro	10	1	jeu
1030580	LS 3X ¾ Euro	290	1	jeu
1030581	LS 4X ¾ Euro	225	1	jeu
1030582	LS 6X ¾ Euro	155	1	jeu

Uponor Vario PLUS collecteur plancher

 1042471	FM 1X ¾ Euro	10	1	jeu
1030583	FM 3X ¾ Euro	174	1	jeu
1030584	FM 4X ¾ Euro	135	1	jeu
1030585	FM 6X ¾ Euro	93	1	jeu

Uponor Vario PLUS ensemble collecteur

 1009209	K1	248	1	pièce
---	----	-----	---	-------

Uponor Vario PLUS moteur NC

 1000138	24V MT30x1,5	10	1	pièce
1005605	230V MT30x1,5	10	1	pièce

Uponor Vario Régulateur de pression différentielle Compact G1 - G1

 NEW 1137437	G1 - G1	125	1	Jeu
--	---------	-----	---	-----

Uponor Vario Vanne de régulation G1-Rp1

 NEW 1137413		10	1	Jeu
--	--	----	---	-----

Uponor Vario PLUS actionneur PRO DCC 100kOhm

 1005544	24V NC MT30x1,5 0-10V DC	100	1	pièce
---	-----------------------------	-----	---	-------

Uponor Vario raccord de compression PEX

 1065283	14x2,0-G¾"FT Euro	25	1	pièce
1065284	16x1,8/2,0-G¾"FT Euro	25	1	pièce
1065286	17x2,0-G¾"FT Euro	25	1	pièce
1065290	20x1,9/2,0-G¾"FT Euro	25	1	pièce

Uponor Vario PLUS Coude 90°

 1032702	122/42	5	1	jeu
---	--------	---	---	-----

N° art.	Dimension	UL	UE	unité
---------	-----------	----	----	-------

Uponor Vario PLUS ensemble de connexion

 1005227		10	1	jeu
---	--	----	---	-----

Uponor Vario PLUS raccord tuyau souple

 1009214	G¾ x ½	10	1	pièce
---	--------	----	---	-------

Uponor Vario PLUS jeu d'entretoises

 1009215		10	1	pièce
---	--	----	---	-------

Uponor Vario PLUS Kit isolation

 1063207		-	1	jeu
---	--	---	---	-----

Uponor Vario étiquettes de circuit

 1005063	47x10mm	-	1	jeu
---	---------	---	---	-----

Uponor Vario PLUS thermomètre

 1034524	D=40mm	20	1	jeu
--	--------	----	---	-----

Uponor Vario PLUS débitmètre

 1009217	4 l/min	20	1	pièce
---	---------	----	---	-------

Uponor Vario PLUS inser. vanne alim. scale 1-5

 1034523		-	20	pièce
---	--	---	----	-------

Uponor Vario PLUS vanne retour

 1005250		10	1	pièce
---	--	----	---	-------

Uponor Vario Insert. vanne retour

 1005099		10	1	pièce
---	--	----	---	-------

Uponor Vario poignée, blanc

 1005101		-	1	pièce
---	--	---	---	-------

Uponor Vario Poignée manuelle COMP

 1005104		100	10	pièce
---	--	-----	----	-------















Uponor Vario Insert. vanne aliment.

 1005098		-	1	pièce
---	--	---	---	-------



Uponor Vario M

N° art.	Dimension	UL	UE	unité
---------	-----------	----	----	-------

Uponor Vario M Collecteur av. débitmètre FM

 1085944	2X G $\frac{3}{4}$ Euro	80	1	pièce
 1085945	3X G $\frac{3}{4}$ Euro	80	1	pièce
 1085946	4X G $\frac{3}{4}$ Euro	80	1	pièce
 1085947	5X G $\frac{3}{4}$ Euro	80	1	pièce
 1085948	6X G $\frac{3}{4}$ Euro	80	1	pièce
 1085949	7X G $\frac{3}{4}$ Euro	80	1	pièce
 1085950	8X G $\frac{3}{4}$ Euro	80	1	pièce
 1085951	9X G $\frac{3}{4}$ Euro	80	1	pièce
 1085952	10X G $\frac{3}{4}$ Euro	80	1	pièce
 1086250	11X G $\frac{3}{4}$ Euro	108	1	pièce
 1086251	12X G $\frac{3}{4}$ Euro	108	1	pièce
 1087129	13X G $\frac{3}{4}$ Euro	30	1	pièce
 1087130	14X G $\frac{3}{4}$ Euro	30	1	pièce
 1087131	15X G $\frac{3}{4}$ Euro	30	1	pièce

Uponor Vario thermische aandrijving S

 1087763	230V FT 30x1,5	100	1	Jeu
 1087778	24V FT 30x1,5	100	1	Jeu

N° art.	Dimension	UL	UE	unité
---------	-----------	----	----	-------

Uponor Vario Régulateur de pression différentielle Compact G1 - G1

 NEW 1137437	G1 - G1	125	1	Jeu
---	---------	-----	---	-----

Uponor Vario Vanne de régulation G1-Rp1

 NEW 1137413		10	1	Jeu
---	--	----	---	-----

Uponor Vario M Manifold - Débitmètre 0-5l/min

 NEW 1121531	0-5l/min	10	1	pièce
---	----------	----	---	-------

Uponor Vario M Console

 1087531		-	1	jeu
--	--	---	---	-----

Uponor Vario M Vanne de remplissage et de vidange

 1120810		10	1	pièce
--	--	----	---	-------

Uponor Vario étiquettes de circuit

 1005063	47x10mm	-	1	jeu
--	---------	---	---	-----

Uponor Vario M vanne de retour

 1085957		-	1	pièce
--	--	---	---	-------

Uponor Vario M thermomètre

 1085958		-	1	Jeu
--	--	---	---	-----

Uponor Vario M jeu étriers sécurité

 1085959	3x2	-	1	Jeu
--	-----	---	---	-----

Uponor Vario S

N° art.	Dimension	UL	UE	unité
---------	-----------	----	----	-------

Uponor Vario S collecteur inox FM

 1086538	2X $\frac{3}{4}$ Euro	108	1	pièce
1086539	3x $\frac{3}{4}$ Euro	108	1	pièce
1086540	4x $\frac{3}{4}$ Euro	108	1	pièce
1086541	5x $\frac{3}{4}$ Euro	108	1	pièce
1086542	6x $\frac{3}{4}$ Euro	72	1	pièce
1086543	7X $\frac{3}{4}$ Euro	72	1	pièce
1086544	8x $\frac{3}{4}$ Euro	72	1	pièce
1086545	9x $\frac{3}{4}$ Euro	72	1	pièce
1086546	10x $\frac{3}{4}$ Euro	48	1	pièce
1086547	11x $\frac{3}{4}$ Euro	48	1	pièce
1086548	12x $\frac{3}{4}$ Euro	48	1	pièce
1088864	13x $\frac{3}{4}$ Euro	48	1	pièce
1088865	14X $\frac{3}{4}$ Euro	36	1	pièce
1088866	15x $\frac{3}{4}$ Euro	36	1	pièce
1088867	16x $\frac{3}{4}$ Euro	36	1	pièce

Uponor Vario S collecteur inox LS

 1088045	2X $\frac{3}{4}$ Euro	108	1	pièce
1088046	3X $\frac{3}{4}$ Euro	108	1	pièce
1088047	4X $\frac{3}{4}$ Euro	108	1	pièce
1088048	5X $\frac{3}{4}$ Euro	108	1	pièce
1088049	6X $\frac{3}{4}$ Euro	72	1	pièce
1088050	7X $\frac{3}{4}$ Euro	72	1	pièce
1088051	8X $\frac{3}{4}$ Euro	72	1	pièce
1088052	9X $\frac{3}{4}$ Euro	72	1	pièce
1088053	10X $\frac{3}{4}$ Euro	48	1	pièce
1088054	11X $\frac{3}{4}$ Euro	48	1	pièce
1088055	12x $\frac{3}{4}$ Euro	48	1	pièce
1088868	13x $\frac{3}{4}$ Euro	48	1	pièce
1088869	14x $\frac{3}{4}$ Euro	36	1	pièce
1088870	15X $\frac{3}{4}$ Euro	36	1	pièce
1088871	16X $\frac{3}{4}$ Euro	36	1	pièce

Uponor Vario Actionneur NL NC

 1020261	230V FT30X1,5	100	1	pièce
1020262	24V FT30X1,5	100	1	pièce

N° art.	Dimension	UL	UE	unité
---------	-----------	----	----	-------

Uponor Vario étiquettes de circuit

 1005063	47x10mm	-	1	jeu
--	---------	---	---	-----

Uponor Vario Régulateur de pression différentielle Compact G1 - G1

 NEW 1137437	G1 - G1	125	1	Jeu
--	---------	-----	---	-----

Uponor Vario Vanne de régulation G1-Rp1

 NEW 1137413		10	1	Jeu
--	--	----	---	-----

Uponor Vario 2 vannes d'arrêt à billes

 1059132	NP G1-G1	10	1	jeu
--	----------	----	---	-----

Uponor Vario vannes à billes

 1086558	$\frac{3}{4}$ -G1	10	1	jeu
---	-------------------	----	---	-----

Uponor Vario coude vannes à bille

 1086559	Rp $\frac{3}{4}$ " - G1"	-	1	jeu
1090732	G1-Rp1	260	1	jeu

Uponor Vario rotule d'assemblage

 1058573	G1-G1A	30	1	pièce
--	--------	----	---	-------

Uponor Vario vanne de réglage fin

 1005107	$\frac{1}{2}$ " - G $\frac{3}{4}$	50	1	pièce
--	-----------------------------------	----	---	-------

Uponor Vario vanne de fermeture retour

 1005108	$\frac{1}{2}$ " - G $\frac{3}{4}$	50	1	pièce
--	-----------------------------------	----	---	-------

Uponor Vario S

N° art.	Dimension	UL	UE	unité
---------	-----------	----	----	-------

Uponor Vario connexion HM horizontale

 1090730	G3/4" 110mm	250	1	jeu
 1090728	G1" 130mm	-	1	jeu

Uponor Vario connexion HM verticale

 1090731	G3/4" 110mm	250	1	jeu
 1090729	G1" 130mm	250	1	jeu

Uponor Vario joint pour capteur HM

 1007177	M10-5mm	-	1	pièce
--	---------	---	---	-------

Uponor Vario coude de connexion

 1000110	1"FT-1"MT	50	10	pièce
--	-----------	----	----	-------

Uponor Aqua PLUS b. d'ext. coll., j. pl.

 1001337	3/4"FT	250	10	pièce
--	--------	-----	----	-------

N° art.	Dimension	UL	UE	unité
---------	-----------	----	----	-------

Uponor Vario thermomètre S

 1086537		10	1	jeu
--	--	----	---	-----

Uponor Vario S vanne LS

 1088056		-	10	pièce
--	--	---	----	-------

Uponor Vario S Distributeur Débitmètre

 1087608		-	10	pièce
--	--	---	----	-------

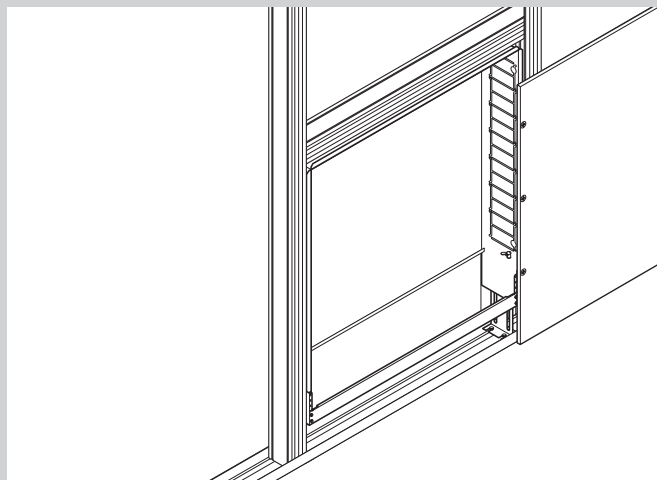
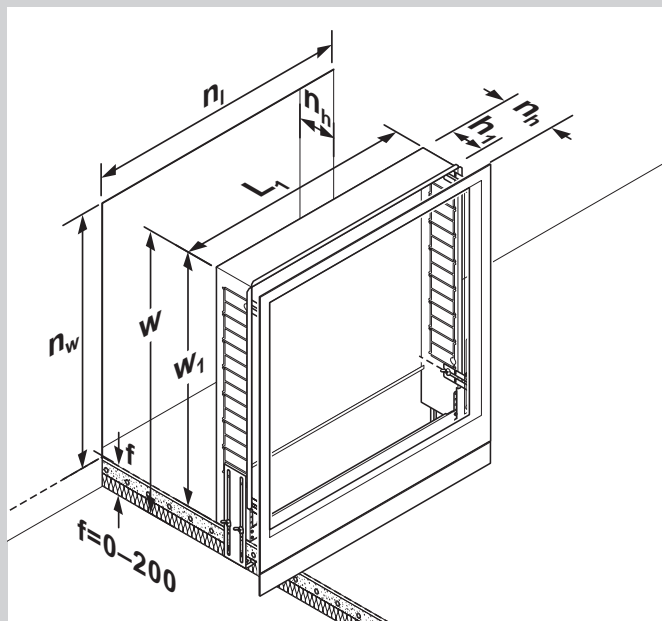

Cotes de montage armoires de distribution

Options d'équipement et cotes de montage pour les armoires de distribution Vario PLUS, Vario M et Vario S



$w_1 = 730 \text{ mm}$
 $w = w_1 + f$
 $n_w = w_1 + f + 20 \text{ mm}$
 $n_1 = l_1 + 40 \text{ mm}$

Chauffage surface

avec armoire de distribution Uponor Vario PLUS	Var.	Configuration	Armoire de distribution largeur l1 (mm)						h1 (mm)	nh min. (mm)
			550	700	850	1000	1150	1300		
convient pour nombre de circuits de chauffage										
	1	Vertical (sans kit de raccordement Vario WMZ)	2-4	5-7	8-10	11-13	14-15	-	80	80*
	2	Vertical (avec kit de raccordement Vario WMZ)	2-4	5-7	8-10	11-13	14-15	-	80	95
	3	Latéral (sans kit de raccordement Vario WMZ)	2-5	6-8	9-11	12-14	15	-	80	80*
	4	Latéral (avec kit de raccordement Vario WMZ)	-	2-3	4-6	7-9	10-12	13-15	80	95
	5	Avec groupe de pompes Push 23 B	2-3	4-6	7-9	10-12	13-15	-	110	110*
	6	Avec groupe de pompes MPG 10 / Push 23 A	-	2-4	5-7	8-10	11-13	14-15	110	110*
	7	Latéral avec régulateur de pression différentielle Viva et WMZ	-	2	3-5	6-8	9-11	12-14	80	80*
	8	Vertical avec régulateur de pression différentielle Viva et WMZ	-	2-3	4-6	7-9	10-12	13-15	80	95
avec armoire de distribution Uponor Vario M	Var.	Configuration	Armoire de distribution largeur l1 (mm)						h1 (mm)	nh min. (mm)
convient pour nombre de circuits de chauffage										
	1	Vertical (sans kit de raccordement Vario WMZ)	2-5	6-8	9-10	11-13	14-15	-	80	80*
	2	Vertical (avec kit de raccordement Vario WMZ)	2-5	6-8	9-10	11-13	14-15	-	80	95
	3	Latéral (sans kit de raccordement Vario WMZ)	2-6	7-9	10-11	12-14	15	-	80	80*
	4	Latéral (avec kit de raccordement Vario WMZ)	-	2-4	5-7	8-10	11-12	13-15	80	95
	5	Avec groupe de pompes Push 23 B	2-4	5-7	8-10	11-12	13-15	-	110	110*
	6	Avec groupe de pompes MPG 10 / Push 23 A	-	2-4	5-7	8-10	11-13	14-15	110	110*
	7	Latéral avec régulateur de pression différentielle Viva et WMZ	-	2-3	4-6	7-9	10-11	12-14	80	80*
	8	Vertical avec régulateur de pression différentielle Viva et WMZ	-	2-4	5-7	8-10	11-12	13-15	80	95
avec armoire de distribution Uponor Vario S	Var.	Configuration	Armoire de distribution largeur l1 (mm)						h1 (mm)	nh min. (mm)
convient pour nombre de circuits de chauffage										
	1	Vertical (sans kit de raccordement Vario WMZ)	2-5	6-8	9-11	12-14	15-16	-	80	80*
	2	Vertical (avec kit de raccordement Vario WMZ)	2-5	6-8	9-11	12-14	15-16	-	80	95
	3	Latéral (sans kit de raccordement Vario WMZ)	2-6	7-9	10-12	13-15	16	-	80	80*
	4	Latéral (avec kit de raccordement Vario WMZ)	-	2-4	5-7	8-10	11-13	14-16	80	95
	5	Avec groupe de pompes Push 23 B	2-4	5-7	8-10	11-13	14-16	-	110	110*
	6	Avec groupe de pompes MPG 10 / Push 23 A	-	2-4	5-7	8-10	11-13	14-16	110	110*
	7	Latéral avec régulateur de pression différentielle Viva et WMZ	-	2-3	4-6	7-9	10-12	13-15	80	80*
	8	Vertical avec régulateur de pression différentielle Viva et WMZ	-	2-4	5-7	8-10	11-13	14-16	80	95

* plus 10 mm si la porte plastique est utilisée

Uponor Vario

N° art.	Dimension	UL	UE	unité
---------	-----------	----	----	-------

Uponor Vario chassis d'armoire IW

 1093491	550x730x110mm	18	1	pièce
1093492	700x730x110mm	16	1	pièce
1093493	850x730x110mm	13	1	pièce
1093494	1000x730x110mm	12	1	pièce
1093495	1150x730x110mm	8	1	pièce
1093496	1300x730x110mm	8	1	pièce

Uponor Vario chassis d'armoire IW

 1093497	550x730x80mm	28	1	pièce
1093498	700x730x80mm	25	1	pièce
1093499	850x730x80mm	19	1	pièce
1093500	1000x730x80mm	18	1	pièce
1093501	1150x730x80mm	12	1	pièce
1093502	1300x730x80mm	12	1	pièce

Uponor Vario châssis/porte IW S

 1093528	550x730mm	35	1	pièce
1093541	700x730mm	30	1	pièce
1093542	850x730mm	25	1	pièce
1093543	1000x730mm	20	1	pièce
1093544	1150x730mm	15	1	pièce
1093546	1300x730mm	15	1	pièce

Uponor Vario châssis/porte IW P

 1093547	550x730mm	35	1	pièce
1093548	700x730mm	30	1	pièce
1093549	850x730mm	25	1	pièce
1093550	1000x730mm	20	1	pièce
1093551	1150x730mm	15	1	pièce
1093552	1300x730mm	15	1	pièce

Uponor Vario serrure 2 clés porte

 1093554		200	1	pièce
--	--	-----	---	-------

Uponor Vario glissière pour armoire

 1093555		200	1	pièce
--	--	-----	---	-------

N° art.	Dimension	UL	UE	unité
---------	-----------	----	----	-------

Uponor Vario set de fixation

 OUT 1093522 (5pcs)		200	1	pièce
--	--	-----	---	-------

OUT Livraison dans la limite des stocks disponibles.
L'article expire au cours de l'année.

Uponor Vario Armoire de distribution OW

 NEW 1136215	450x730x135	25	1	pièce
NEW 1136216	600x730x135	17	1	pièce
NEW 1136217	750x730x135	15	1	pièce
NEW 1136218	900x730x135	12	1	pièce
NEW 1136219	1050x730x135	11	1	pièce
NEW 1136220	1200x730x135	7	1	pièce
NEW 1136221	1350x730x135	7	1	pièce
NEW 1136222	1550x730x135	7	1	pièce

Uponor Vario Fond d'armoire OW

 NEW 1136223	450x730	5	1	pièce
NEW 1136224	600x730	5	1	pièce
NEW 1136225	750x730	5	1	pièce
NEW 1136226	900x730	5	1	pièce
NEW 1136227	1050x730	5	1	pièce
NEW 1136228	1200x730	5	1	pièce
NEW 1136229	1350x730	5	1	pièce
NEW 1136230	1550x730	5	1	pièce

Uponor Magna Armoire de distribution montée en surface

 1060553	1010x835x200mm	-	1	pièce
1060554	1910x835x200mm	-	1	pièce
1060555	2310x835x200mm	-	1	pièce

Uponor Vario coffret mural AP

 OUT 1045478	600x156mm	11	1	pièce
OUT 1045479	800x156mm	10	1	pièce
OUT 1045480	1000x156mm	9	1	pièce
OUT 1045481	1350x156mm	8	1	pièce

Uponor Vario panneau arrière d'armoire AP

 OUT 1045482	580mm	15	1	pièce
OUT 1045483	780mm	30	1	pièce
OUT 1045484	980mm	20	1	pièce
OUT 1045485	1330mm	-	1	pièce

OUT Livraison dans la limite des stocks disponibles.
L'article expire au cours de l'année.

Régulations de la température de locaux individuels pour habitations

Guide-système Uponor pour les régulations de la température de locaux individuels pour le chauffage/refroidissement de surface dans les habitations

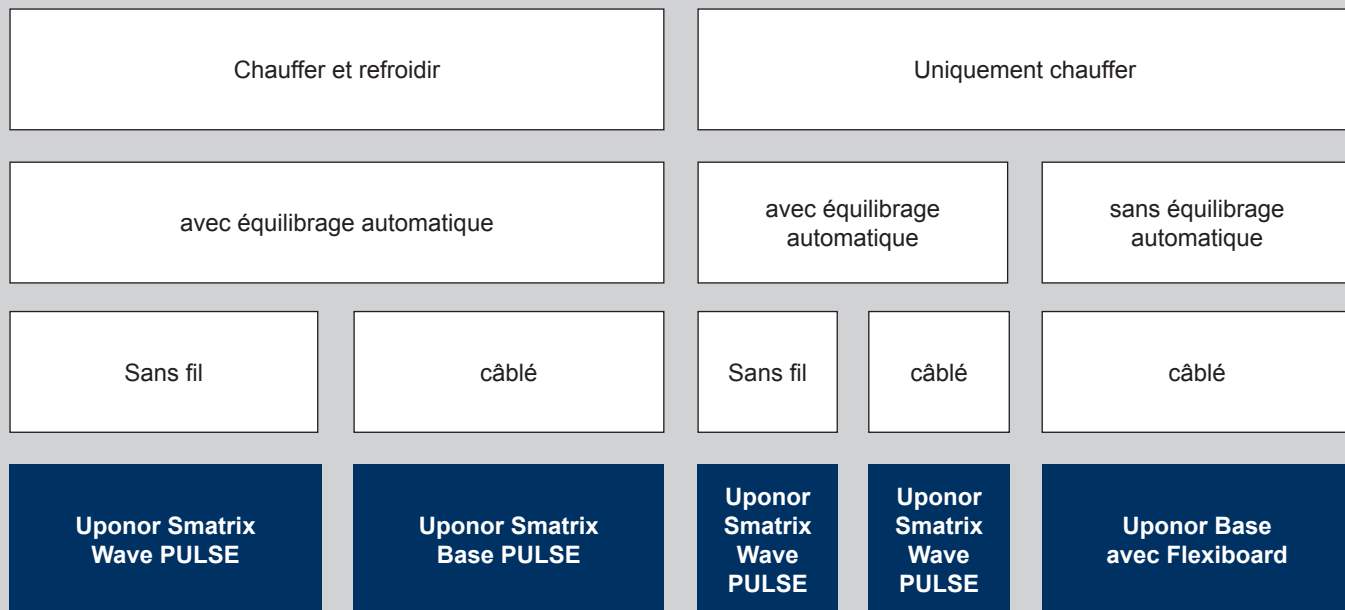

Chauffage surface

La régulation Uponor	... est une :
Uponor Smatrix Wave PULSE	Régulation de la température de locaux individuels sans fil commandée par appli pour chauffer et refroidir avec de nombreuses possibilités, p.ex. connectivité avec Smart Home (<i>Amazon Alexa, Google Home</i>) et Cloud
Uponor Smatrix Wave	Régulation de température ambiante sans fil pour le chauffage et le refroidissement de surface
Uponor Smatrix Wave PULSE	Régulation de la température de locaux individuels câblée commandée par appli pour chauffer et refroidir avec de nombreuses possibilités, p.ex. connectivité avec Smart Home (<i>Amazon Alexa, Google Home</i>) et Cloud
Uponor Smatrix Base PRO	Régulation de la température de locaux individuels câblée pour chauffer et refroidir avec un maximum de 16 modules de régulations pour les bâtiments commerciaux et les objets de grande taille
Uponor Base	Régulation conventionnelle de la température de locaux individuels câblée 230 V pour un réglage simple de la température ambiante
Uponor Smatrix Style	Sonde ambiante design avec surveillance de l'humidité pour les régulations de température ambiantes Smatrix Wave/Base PULSE et Smatrix Base PRO
Smatrix Move	Régulateur de la température de départ sur base de la température extérieure pour chauffer et refroidir
Smatrix Move PRO	Régulateur multizone de la température de départ sur base de la température extérieure pour les bâtiments commerciaux pour chauffer ou chauffer/refroidir et avec déneigement et dégivrement supplémentaire

Eventail des fonctions Smatrix Wave/Base

Uponor Smatrix Technique de régulation	Version complète		sans Cloud		uniquement module de régulation	
	 Smatrix Wave PULSE	 Smatrix Wave PULSE	 Smatrix Wave PULSE	 Smatrix Wave PULSE	 Smatrix Wave PULSE	 Smatrix Wave PULSE
Accès distant	■	■				
Réglage confortable	■	■				
Programmes d'abaissement de la température	■	■				
Mises à jour par appli	■	■				
Connectivité Alexa	■	■				
Activation à distance d'autres composants par module à relais	■					
Accès local via WLAN	■	■	■	■		
Limitation maxi/mini de la température réglée	■	■	■	■		
Création d'un groupe de régulation comprenant 4 modules de régulation	■	■	■	■		
Possibilités de conversion chauffer/ refroidir étendues	■	■	■	■		
Mode central pour l'abaissement de la température	■	■	■	■		
Équilibrage automatique	■	■	■	■	■	■
Chauffer et refroidir	■	■	■	■	■	■
Barrette de contacteurs RF		■		■		■
Régulation d'éléments chauffants	■	■	■	■	■	■

Uponor Smatrix Wave / Pulse

N° art.	Dimension	UL	UE	unité
---------	-----------	----	----	-------

Uponor Smatrix Wave kit de démarrage Pulse S

 1093284		3	1	jeu
---	--	---	---	-----

Uponor Smatrix Wave kit de démarrage Pulse L

 1093287		2	1	jeu
---	--	---	---	-----

Uponor Smatrix interface com R-208

 1093030		16	1	pièce
---	--	----	---	-------

Uponor Smatrix Wave contrôleur Pulse X-265 6X

 1093021		4	1	pièce
---	--	---	---	-------

Uponor Smatrix Wave module esclave Pulse M-262 6X

 1093133		16	1	pièce
--	--	----	---	-------



Uponor Smatrix Wave antenne Pulse A-265

 1093028		16	1	pièce
---	--	----	---	-------

Uponor Smatrix Wave Module relais M-161

 1071673	2X	16	1	pièce
---	----	----	---	-------

Uponor Smatrix Wave thermostat D+RH Style T-169

 1087816	wit	180	1	pièce
 1087817	zwart	180	1	pièce

Uponor Smatrix Wave capt. temp. RH Style T-161

 1087815		180	1	pièce
---	--	-----	---	-------

N° art.	Dimension	UL	UE	unité
---------	-----------	----	----	-------

Uponor Smatrix Base cadre mural T-141

 1122237		20	1	pièce
---	--	----	---	-------

Uponor Smatrix Wave thermostat P+RH T-168

 1086984	RAL9016	75	1	pièce
---	---------	----	---	-------

Uponor Smatrix Wave thermostat D T-166

 1086982	RAL9016	75	1	pièce
---	---------	----	---	-------

Uponor Smatrix Wave thermostat standard T-165 POD

 1086981	RAL9016	75	1	pièce
---	---------	----	---	-------

Uponor Smatrix Wave thermostat public T-163

 1086979	RAL9016	75	1	pièce
---	---------	----	---	-------

Uponor Smatrix Wave Tête thermostatique T-162

 1071660		16	1	pièce
---	--	----	---	-------

Uponor Smatrix châssis mural T-X A-1XX

 1086986	RAL9016	250	1	pièce
---	---------	-----	---	-------

Uponor Smatrix sonde sol/distance S-1XX

 1071684		63	1	pièce
---	--	----	---	-------

Uponor Smatrix relais chaud froid M-1XX

 1083576	24V	84	1	pièce
---	-----	----	---	-------

Uponor Smatrix relais chaud froid M-1XX

 1083577	230V	16	1	pièce
---	------	----	---	-------

Uponor Smatrix actionneur Retrofit A-XXX

 1083575	24V, NC, 1W	100	1	jeu
---	-------------	-----	---	-----

Uponor Smatrix Base / Pulse

N° art.	Dimension	UL	UE	unité
---------	-----------	----	----	-------

Uponor Smatrix Base kit de démarrage Pulse S

 1093280		3	1	jeu
--	--	---	---	-----

Uponor Smatrix Base kit de démarrage Pulse L

 1093282		2	1	jeu
--	--	---	---	-----

Uponor Smatrix interface com R-208 Pulse

 1093030		16	1	pièce
--	--	----	---	-------

Uponor Smatrix Base régulation Pulse X-245 BUS 6X

 1093017		4	1	pièce
--	--	---	---	-------

Uponor Smatrix Base module esclave Pulse M-242 BUS 6X

 1093134		16	1	pièce
---	--	----	---	-------

Uponor Smatrix Base ext. pour controleur Pulse M-243 BUS 6X

 1093135		16	1	pièce
--	--	----	---	-------

Uponor Smatrix Base thermostat D+RH Style T-149 Bus

 1087813 wit		180	1	pièce
1087814 zwart		180	1	pièce

Uponor Smatrix Base PRO capt. temp. RH Style T-141 Bus

 1087812 FLUSH		180	1	pièce
--	--	-----	---	-------

Uponor Smatrix Base cadre mural T-141

 1122237		20	1	pièce	9,35
--	--	----	---	-------	------

Uponor Smatrix Base thermostat P+RH T-148 Bus

 1086977 RAL9016		75	1	pièce
--	--	----	---	-------

Uponor Smatrix Base thermostat D T-146 Bus

 1086976 RAL9016		75	1	pièce
--	--	----	---	-------

N° art.	Dimension	UL	UE	unité
---------	-----------	----	----	-------

Uponor Smatrix Base thermostat standard T-145 Bus POD

 1086975 RAL9016		75	1	pièce
--	--	----	---	-------

Uponor Smatrix Base thermostat encastré T-144 Bus

 1086973 RAL9016		60	1	pièce
--	--	----	---	-------

Uponor Smatrix Base thermostat public T-143 Bus

 1086972 RAL9016		75	1	pièce
--	--	----	---	-------

Uponor Smatrix sonde sol/distance S-1XX

 1071684		63	1	pièce
--	--	----	---	-------

Uponor Smatrix Base plaque murale Style T-149 A-14X

 1087821 wit		90	1	pièce
1087822 zwart		90	1	pièce

Uponor Smatrix châssis mural T-X A-1XX

 1086986 RAL9016		250	1	pièce
--	--	-----	---	-------

Uponor Smatrix Base cable bus A-145

 1071670 50m		2	1	pièce
--	--	---	---	-------

Uponor Smatrix relais chaud froid M-1XX

 1083576 24V		84	1	pièce
--	--	----	---	-------

Uponor Smatrix relais chaud froid M-1XX

 1083577 230V		16	1	pièce
---	--	----	---	-------

Uponor Smatrix actionneur Retrofit A-XXX

 1083575 24V, NC, 1W		100	1	jeu
--	--	-----	---	-----

Uponor Smatrix Base PRO

N° art.	Dimension	UL	UE	unité
---------	-----------	----	----	-------

Uponor Smatrix Base PRO régulateur X-147 Bus

 1087162	6X	4	1	pièce
---	----	---	---	-------

Uponor Smatrix Base module d'extension M-140 Bus

 1071686	6X	16	1	pièce
---	----	----	---	-------

Uponor Smatrix Base module d'extension M-141 Bus

 1071651	8X	16	1	pièce
---	----	----	---	-------

Uponor Smatrix Base PRO interface I-147 Bus

 1087161		7	1	pièce
---	--	---	---	-------

N° art.	Dimension	UL	UE	unité
---------	-----------	----	----	-------

Uponor Smatrix Base PRO capt. temp. RH Style T-141 Bus

 1087812	FLUSH	180	1	pièce
---	-------	-----	---	-------

Uponor Smatrix Base cadre mural T-141

 1122237		20	1	pièce
---	--	----	---	-------

Uponor Smatrix Base PRO module passerell R-147 KNX

 1087164		-	1	pièce
---	--	---	---	-------

Chauffage surface

Uponor Base

N° art.	Dimension	UL	UE	unité
---------	-----------	----	----	-------

Uponor Base Module de régulation X-23

 1058426	6X 230V	200	1	pièce
--	---------	-----	---	-------

Uponor Base flexiboard X-24

 1088331	6X 230V	-	1	pièce
--	---------	---	---	-------

Uponor Base flexiboard logiq. pompage X-25

 1089086	6X 230V	-	1	pièce
--	---------	---	---	-------

Uponor Base flexiboard X-26

 1089087	8X 230V	-	1	pièce
--	---------	---	---	-------

Uponor Base flexiboard av. log. pompage X-27

 1089088	8X 230V	-	1	pièce
--	---------	---	---	-------

N° art.	Dimension	UL	UE	unité
---------	-----------	----	----	-------

Uponor Base thermostat standard T-23

 1058422	230V RAL9010	160	1	pièce
--	--------------	-----	---	-------

Uponor Base thermostat encastrable T-24

 1058423	230V	-	1	pièce
--	------	---	---	-------

Uponor Base thermostat C/R T-25

 1058424	230V	-	1	pièce
--	------	---	---	-------

Uponor Base thermostat d'ambiance prog. T-26

 1058425	230V RAL9010	-	1	pièce
--	--------------	---	---	-------

Uponor Base capteur à distance

 1047459	230V	-	1	pièce
---	------	---	---	-------

Uponor Vario B Moteur NC

 1022244	230V FT28x1,5	10	1	pièce
--	---------------	----	---	-------

Uponor Vario Actionneur NL NC

 1020261	230V FT30x1,5	100	1	pièce
--	---------------	-----	---	-------

Uponor Vario PLUS moteur NC

 1005605	230V MT30x1,5	10	1	pièce
--	---------------	----	---	-------

Régulation de la température ambiante

N° art.	Dimension	UL	UE	unité
---------	-----------	----	----	-------

N° art.	Dimension	UL	UE	unité
---------	-----------	----	----	-------

Uponor Smatrix Move PRO

Uponor Smatrix Move PRO régulateur X-159



1087155		10	1	pièce
---------	--	----	---	-------

Uponor Smatrix Move PRO kit fonte neige S-152 + S-158



1087158		-	1	jeu
---------	--	---	---	-----

1087156		5	1	pièce
---------	--	---	---	-------

Uponor Smatrix Move PRO capt. temp. amb. S-155



1087159		10	1	pièce
---------	--	----	---	-------

Uponor Smatrix Move PRO sonde d'humidité S-157



1087160		75	1	pièce
---------	--	----	---	-------

Uponor Smatrix Move PRO ensemb. condens. S-159



1087165		10	1	jeu
---------	--	----	---	-----

Chauffage surface

Régulation de la température ambiante

N° art.	Dimension	UL	UE	unité
---------	-----------	----	----	-------

N° art.	Dimension	UL	UE	unité
---------	-----------	----	----	-------

Uponor Smatrix Move

Uponor Smatrix Move régulateur X-157 Wired



1071693		4	1	jeu
---------	--	---	---	-----

Uponor Smatrix relais chaud froid M-1XX



1083577	230V	16	1	pièce
---------	------	----	---	-------

Uponor Smatrix Move sonde retour S-152



1071661	3m	63	1	pièce
---------	----	----	---	-------

Uponor Smatrix Move actionneur motorisé 230V



1002357		-	1	pièce
---------	--	---	---	-------

Uponor Smatrix sonde extérieure S-1XX



1071671		45	1	pièce
---------	--	----	---	-------

Régulation de la température ambiante

N° art.	Dimension	UL	UE	unité
---------	-----------	----	----	-------

Uponor Fluvia

Uponor Fluvia T module de régulation Push-12-CH-X

 1085982		50	1	pièce
---	--	----	---	-------

Uponor Fluvia T groupe de pompe Push-12 AC-G

 1095128		60	1	pièce
---	--	----	---	-------

Uponor Fluvia adaptateur à visser en Y

 1005675	2xG $\frac{3}{4}$ - $\frac{3}{4}$ "Euro	50	1	jeu
---	---	----	---	-----

Uponor Vario vanne remplissage/vidange

 1061802	$\frac{3}{4}$ " - $\frac{3}{4}$ "	10	1	jeu
---	-----------------------------------	----	---	-----

Uponor Aqua PLUS b. d'ext. coll., j. pl.

 1001337	$\frac{3}{4}$ "FT	250	10	pièce
---	-------------------	-----	----	-------

Uponor Fluvia Move Groupe de pompage Push-23-A-AC

 1085008		30	1	pièce
---	--	----	---	-------

Uponor Fluvia T groupe de pompe Push-23-B-W

 1078304		55	1	pièce
---	--	----	---	-------

Uponor Fluvia Move groupe de pompe MPG-10-A-W

 1078306		30	1	pièce
---	--	----	---	-------

Uponor Fluvia groupe de pompe MPG-10-B-W

 1078307		30	1	pièce
---	--	----	---	-------

N° art.	Dimension	UL	UE	unité
---------	-----------	----	----	-------

Uponor Vario rotule d'assemblage

 1058573	G1-G1A	30	1	pièce
---	--------	----	---	-------

Uponor Fluvia limiteur de temp. max.

 1005504	5-60	10	1	pièce
---	------	----	---	-------

Uponor Fluvia Move groupe de pompe PPG-30-A-W

 1084143		22	1	pièce
---	--	----	---	-------

Uponor Smatrix Move actionneur pro

 1002356	A-15X 24V 0-10 V	-	1	pièce
---	------------------	---	---	-------

Uponor Smatrix Move actionneur motorisé 230V

 1002357		-	1	pièce
---	--	---	---	-------

Technologie de connexion, raccords et outillages pour Uponor Ecoflex

Type	Dimension [mm]	Tube intérieure	Matériau d'isolation	Tube extérieur	Température / Pression de la barre	Longu- eur [m]	N° art.	Certifications
VIP Thermo Single 	40 x 3,7/140	PE-Xa + EVOH	VIP + Mousse PEX	PE-HD	max. 95 °C / 6 bar	200	1095714	Certification de système CSTB
	50 x 4,6/140					200	1095715	
	63 x 5,8/140					200	1095716	
	75 x 6,8/140					200	1095717	
	90 x 8,2/175					100	1095718	
	110 x 10,0/175					100	1095719	
	125 x 11,4/200					120	1095720	
VIP Thermo Twin 	2x25 x 2,3/140	PE-Xa + EVOH	VIP + Mousse PEX	PE-HD	max. 95 °C / 6 bar	200	1118580	Certification de système CSTB
	2x32 x 2,9/140					200	1118581	
	2x40 x 3,7/175					200	1118582	
	2x50 x 4,6/175					200	1118583	
	2x63 x 5,8/200					100	1118584	
	2x75 x 6,8/250					100	1118585	
	Thermo Single <small>optional mit Heizkabel</small> 					25 x 2,3/140	PE-Xa + EVOH	
32 x 2,9/140		200	1018110					
40 x 3,7/175		200	1018111					
50 x 4,6/175		200	1018112					
63 x 5,8/175		200	1018113					
75 x 6,8/200		100	1018114					
90 x 8,2/200		100	1018115					
110 x 10,0/200		100	1018116					
Thermo Twin 	2x25 x 2,3/175	PE-Xa + EVOH	Mousse PEX	PE-HD	max. 95 °C / 6 bar	200	1018134	Certification de système KOMO selon BRL5609, Certification de système CSTB, GOST
	2x32 x 2,9/175					200	1018135	
	2x40 x 3,7/175					200	1018136	
	2x50 x 4,6/200					100	1018137	
	2x63 x 5,8/200					100	1018138	
Thermo Mini 	25 x 2,3/68	PE-Xa + EVOH	Mousse PEX	PE-HD	max. 95 °C / 6 bar	200	1018132	Certification de système CSTB
	32 x 2,9/68					200	1018133	

Technologie et outils de connexion							
Accessoires	Wipex raccord fileté mâle		Ecoflex raccord fileté mâle	Quick & Easy			
	PN6 + pâte graphite + pince écarteur + inbus	PN6 + pâte graphite + inbus	PN6 + pâte graphite + inbus	Outillages d'expansion M18 6 bar	M18 VLD	Bagues avec bord d'arrêt naturel / blanc	
Embout terminal EPDM							
	•			•	•	•	
	•				•	•	
		•			•	•	
		•			•	•	
		•			•	•	
		•	•				
	•			•			•
	•			•			•
	•			•			•
	•			•	•	•	
	•			•	•	•	
	•			•	•	•	
	•			•	•	•	
	•			•	•	•	
	•			•	•	•	
	•			•	•	•	
	•			•	•	•	
	•			•	•	•	
	•			•	•	•	
	•			•	•	•	
	•			•	•	•	
	•			•	•	•	
	•			•	•	•	
	•			•	•	•	
	•			•	•	•	
	•			•	•	•	
	•			•	•	•	
	•			•	•	•	
	•			•	•	•	
	•			•	•	•	
	•			•	•	•	
	•			•	•	•	
	•			•	•	•	
	•			•	•	•	
	•			•	•	•	
	•			•	•	•	
	•			•	•	•	
	•			•	•	•	
	•			•	•	•	
	•			•	•	•	
	•			•	•	•	
	•			•	•	•	
	•			•	•	•	
	•			•	•	•	
	•			•	•	•	
	•			•	•	•	
	•			•	•	•	
	•			•	•	•	
	•			•	•	•	
	•			•	•	•	
	•			•	•	•	
	•			•	•	•	
	•			•	•	•	
	•			•	•	•	
	•			•	•	•	
	•			•	•	•	
	•			•	•	•	
	•			•	•	•	
	•			•	•	•	
	•			•	•	•	
	•			•	•	•	
	•			•	•	•	
	•			•	•	•	
	•			•	•	•	
	•			•	•	•	
	•			•	•	•	
	•			•	•	•	
	•			•	•	•	
	•			•	•	•	
	•			•	•	•	
	•			•	•	•	
	•			•	•	•	
	•			•	•	•	
	•			•	•	•	
	•			•	•	•	
	•			•	•	•	
	•			•	•	•	
	•			•	•	•	
	•			•	•	•	
	•			•	•	•	
	•			•	•	•	
	•			•	•	•	
	•			•	•	•	
	•			•	•	•	
	•			•	•	•	
	•			•	•	•	
	•			•	•	•	
	•			•	•	•	
	•			•	•	•	
	•			•	•	•	
	•			•	•	•	
	•			•	•	•	
	•			•	•	•	
	•			•	•	•	
	•			•	•	•	
	•			•	•	•	
	•			•	•	•	
	•			•	•	•	
	•			•	•	•	
	•			•	•	•	

Chauffage surface

Technologie de connexion, raccords et outillages pour Uponor Ecoflex

Type	Dimension [mm]	Tube intérieure	Matériau d'isolation	Tube extérieur	Température / Pression de la barre	Longueur [m]	N° art.	Certifications	Accessoires Embout terminal EPDM
	40 x 5,5/140	PE-Xa	VIP + Mousse PEX	PE-HD	max. 95 °C / 10 bar	200	1119047	DVGW, ÖVGW	
	50 x 6,9/140					200	1119048		
	63 x 8,6/140					200	1119049		
	25 x 3,5-20 x 2,8/140	PE-Xa	VIP + Mousse PEX	PE-HD	max. 95 °C / 10 bar	200	1119053	DVGW, ÖVGW	
	32 x 4,4-20 x 2,8/140					200	1119054		
	40 x 5,5-25 x 3,5/140					200	1119055		
	50 x 6,9-32 x 4,4/175					200	1119056		
	25 x 3,5/140	PE-Xa	Mousse PEX	PE-HD	max. 95 °C / 10 bar	200	1018117	DVGW, ÖVGW	
	32 x 4,4/140					200	1018118		
	40 x 5,5/175					200	1018119		
	50 x 6,9/175					200	1018120		
	63 x 8,6/175					200	1018121		
	25 x 3,5-25 x 3,5/175	PE-Xa	Mousse PEX	PE-HD	max. 95 °C / 10 bar	200	1018139	DVGW, ÖVGW	
	32 x 4,4-25 x 3,5/175					200	1018140		
	40 x 5,5-25 x 3,5/175					200	1018141		
	50 x 6,9-25 x 3,5/175					200	1018142		
	2x25 x 2,3-2x25 x 3,5/175	PE-Xa + EVOH + PE-Xa	Mousse PEX	PE-HD	max. 95 °C / 6 / 10 bar	200	1018147	DVGW, ÖVGW	
	2x32 x 2,9-2x25 x 3,5/175					200	1018148		
	2x32 x 2,9-32 x 4,4-25 x 3,5/175					200	1018149		
	25 x 2,3/68	PE 100-RC noir avec couche bleue	Mousse PEX	PE-HD	20 °C / 16 bar	200	1095722	DVGW	
	32 x 2,9/68					200	1095723		
	40 x 3,7/140					200	1095724		
	50 x 4,6/140					200	1095725		
	63 x 5,8/140					200	1095726		
	75 x 6,8/175					100	1095727		
	90 x 8,2/175					100	1095728		
110 x 10,0/200	100	1095729							
	25 x 2,3/68	PE 100-RC noir avec couche bleue	Mousse PEX	PE-HD	20 °C / 16 bar	150	1095730	DVGW	
	32 x 2,9/68					150	1095731		
	40 x 3,7/140					150	1095734		
	50 x 4,6/140					150	1095736		
	63 x 5,8/140					150	1095737		
	75 x 6,8/175					150	1095738		
	90 x 8,2/200					100	1095739		
	110 x 10,0/200					100	1095740		

Système de distribution Uponor Ecoflex

N° art.	Dimension	UL	UE	unité
---------	-----------	----	----	-------

Uponor Ecoflex VIP Thermo

Uponor Ecoflex VIP Thermo Single

 1095714	40X3,7/140	-	200	m
1095715	50X4,6/140	-	200	m
1095716	63X5,8/140	-	200	m
1095717	75X6,8/140	-	200	m
1095718	90X8,2/175	-	150	m
1095719	110X10,0/175	-	150	m
1095720	125X11,4/200	-	120	m

Uponor Ecoflex VIP Thermo Twin

 1118580	2x25x2,3/140	-	200	m
1118581	2x32x2,9/140	-	200	m
1118582	2x40x3,7 /175	-	200	m
1118583	2x50x4,6/175	-	200	m
1118584	2x63x5,8/200	-	100	m
1118585	2x75x6,8/250	-	100	m



N° art.	Dimension	UL	UE	unité
---------	-----------	----	----	-------

Uponor Ecoflex Thermo

Uponor Ecoflex Thermo Single

 1018109	25x2,3/140	-	200	m
1018110	32x2,9/140	-	200	m
1018111	40x3,7/175	-	200	m
1018112	50x4,6/175	-	200	m
1018113	63x5,8/175	-	200	m
1018114	75x6,8/200	-	100	m
1018115	90x8,2/200	-	100	m
1018116	110x10,0/200	-	100	m

Uponor Ecoflex Thermo Twin

 1018134	2x25x2,3/175	-	200	m
1018135	2x32x2,9/175	-	200	m
1018136	2x40x3,7 /175	-	200	m
1018137	2x50x4,6/200	-	100	m
1018138	2x63x5,8/200	-	100	m

Uponor Ecoflex Thermo Mini

 1018132	25x2,3/68	-	200	m
1018133	32x2,9/68	-	200	m
1095574	32x2,9/68 L=25m	50	25	m



Uponor Ecoflex Thermo Mini
Le raccordement de la pompe à chaleur monobloc intelligent: petit rayon de courbure, facile à installer!

Système de distribution Uponor Ecoflex

N° art.	Dimension	UL	UE	unité
---------	-----------	----	----	-------

Uponor Ecoflex VIP Aqua

Uponor Ecoflex VIP Aqua Single

 1119047	40x5,5/140	-	200	m
1119048	50x6,9/140	-	200	m
1119049	63x8,6/140	-	200	m

Uponor Ecoflex VIP Aqua Twin

 1119053	25x3,5-20x2,8/140	-	200	m
1119054	32x4,4-20x2,8/140	-	200	m
1119055	40x5,5-25x3,5/140	-	200	m
1119056	50x6,9-32x4,4/175	-	200	m



N° art.	Dimension	UL	UE	unité
---------	-----------	----	----	-------

Uponor Ecoflex Aqua

Uponor Ecoflex Aqua Single

 1018117	25x3,5/140	-	200	m
1018118	32x4,4/140	-	200	m
1018119	40x5,5/175	-	200	m
1018120	50x6,9/175	-	200	m
1018121	63x8,6/175	-	200	m

Uponor Ecoflex Aqua Twin

 1018139	25x3,5-25x3,5/175	-	200	m
1018140	32x4,4-25x3,5/175	-	200	m
1018141	40x5,5-25x3,5/175	-	200	m
1018142	50x6,9-25x3,5/175	-	200	m

Système de distribution Uponor Ecoflex

N° art. Dimension UL UE unité

Uponor Ecoflex Quattro

Uponor Ecoflex Quattro

	1018147	2x25x2,3-2x25x3,5/175	-	200	m
	1018148	2x32x2,9-2x25x3,5/175	-	200	m
	1018149	2x32x2,9-32x4,4-25x3,5/175	-	200	m

Uponor Ecoflex Supra

Uponor Ecoflex Supra

	1095722	25x2,3/68	-	200	m
	1095723	32x2,9/68	-	200	m
	1095724	40x3,7/140	-	200	m
	1095725	50x4,6/140	-	200	m
	1095726	63x5,8/140	-	200	m
	1095727	75x6,8/175	-	150	m
	1095728	90x8,2/175	-	100	m
	1095729	110x10,0/200	-	100	m

N° art. Dimension UL UE unité

Uponor Ecoflex Supra PLUS

Uponor Ecoflex Supra PLUS cable

	1095730	25x2,3/68 1x10W/m	-	150	m
	1095731	32x2,9/68 1x10W/m	-	150	m
	1095734	40x3,7/140 1x10W/m	-	150	m
	1095736	50x4,6/140 1x10W/m	-	150	m
	1095737	63x5,8/140 1x10W/m	-	150	m
	1095738	75x6,8/175 1x10W/m	-	150	m
	1095739	90x8,2/200 1x10W/m	-	100	m
	1095740	110x10,0/200 1x10W/m	-	100	m

Uponor Ecoflex Supra PLUS Définir

	1120124	25+32/68	-	1	jeu
	1120126	40+50+63/140	-	1	jeu
	1120127	75/175	-	1	jeu
	1120128	90+110/200	-	1	jeu

Uponor Ecoflex Supra PLUS Régulateur 150

	1120123		50	1	pièce
---	----------------	--	----	---	-------

Uponor Ecoflex Supra PLUS Kit électrique S1

	1042310		-	1	pièce
---	----------------	--	---	---	-------

Uponor Ecoflex Supra PLUS Kit électrique S2

	1042311		-	1	pièce
---	----------------	--	---	---	-------

Uponor Ecoflex Supra PLUS Té

	1061641	140/90/68	5	1	pièce
	1061642	200/175/140	3	1	pièce

Uponor Ecoflex bague réduction

	1060991	200/68	8	1	pièce
---	----------------	--------	---	---	-------

Uponor Wipex

N° art.	Dimension	UL	UE	unité
---------	-----------	----	----	-------

Uponor Wipex raccord fileté mâle PN6

 1018328	25x2,3-G1	40	1	pièce
1018329	32x2,9-G1	20	1	pièce
1018330	40x3,7-G1 ¼	10	1	pièce
1018331	50x4,6-G1 ¼	10	1	pièce
1018332	63x5,8-G2	8	1	pièce
1018333	75x6,8-G2	6	1	pièce
1018334	90x8,2-G3	4	1	pièce
1018335	110x10,0-G3	3	1	pièce

Uponor Ecoflex raccord fileté mâle PN6

 1078368	125x11,4-R4	-	1	pièce
--	-------------	---	---	-------

Uponor Ecoflex raccord fileté mâle PN10

 1091505	20x2,8-¾"	10	1	pièce
--	-----------	----	---	-------

Uponor Wipex raccord fileté mâle PN10

 1018336	25x3,5-G1	40	1	pièce
1018338	32x4,4-G1	20	1	pièce
1018339	40x5,5-G1 ¼	10	1	pièce
1018340	50x6,9-G1 ¼	10	1	pièce
1018341	63x8,6-G2	8	1	pièce

Uponor Wipex manchon égal Wipex PN6

 1042972	25x2,3-25x2,3	30	1	pièce
1042973	32x2,9-32x2,9	25	1	pièce
1042980	40x3,7-40x3,7	15	1	pièce
1042984	50x4,6-50x4,6	10	1	pièce
1042981	63x5,8-63x5,8	5	1	pièce
1042985	75x6,8-75x6,8	3	1	pièce
1042986	90x8,2-90x8,2	4	1	pièce
1042987	110x10-110x10	2	1	pièce

Uponor Ecoflex manchon PN6

 1078365	125x11,4-125x11,4	-	1	pièce
--	-------------------	---	---	-------

N° art.	Dimension	UL	UE	unité
---------	-----------	----	----	-------

Uponor Wipex manchon égal Wipex PN10

 1042970	25x3,5-25x3,5	40	1	pièce
1042974	32x4,4-32x4,4	25	1	pièce
1042979	40x5,5-40x5,5	15	1	pièce
1042983	50x6,9-50x6,9	10	1	pièce
1042982	63x8,6-63x8,6	4	1	pièce

Uponor Wipex Té Femelle

 1018345	G1-G1-G1	20	1	pièce
1018346	G1 ¼-G1 ¼-G1 ¼	10	1	pièce
1018347	G2-G2-G2	4	1	pièce
1018348	G3-G3-G3	3	1	pièce

Uponor Ecoflex Té WIPEX Femelle

 1078367	Rp4-Rp4-Rp4	-	1	pièce
--	-------------	---	---	-------

Uponor Wipex coude

 1018350	G1-G1	20	1	pièce
1018351	G1 ¼-G1 ¼	15	1	pièce
1018352	G2-G2	5	1	pièce
1018353	G3-G3	2	1	pièce

Uponor Ecoflex coude

 1078366	Rp4-Rp4	-	1	pièce
--	---------	---	---	-------

Uponor Wipex manchon femelle

 1018355	G1-G1	40	1	pièce
1018356	G1 ¼-G1 ¼	25	1	pièce
1018357	G2-G2	15	1	pièce
1018358	G3-G3	10	1	pièce

Uponor Wipex

N° art.	Dimension	UL	UE	unité
---------	-----------	----	----	-------

Uponor Wipex réduction mâle/femelle

	1018368	G1 ¼-G1	25	1	pièce
	1018369	G1 ½-G1 ¼	25	1	pièce
	1018371	G2-G1	15	1	pièce
	1018372	G2-G1 ¼	15	1	pièce
	1018373	G2 ½-G2	6	1	pièce
	1018374	G3-G1	6	1	pièce
	1018375	G3-G1 ¼	10	1	pièce
	1018376	G3-G2	10	1	pièce
	1009052	G4-G3	6	1	pièce

Uponor Ecoflex réduction mâle-femelle

	1078369	R4-G3	6	1	pièce
---	----------------	-------	---	---	-------

Uponor Wipex bride filetée filet femelle

	1018359	F25/4-85/G1	10	1	pièce
	1018360	F32/4-100/G1 ¼	5	1	pièce
	1018361	F40/4-110/G1 ½	5	1	pièce
	1018362	F50/4-125/G2	4	1	pièce
	1018363	F65/8-145/2 ½	3	1	pièce
	1018364	F80/8-160/G3	3	1	pièce
	1018365	F100/8-180/G4	3	1	pièce

Uponor Ecoflex bride

	1078370	F100/8-180/Rp4	-	1	pièce
---	----------------	----------------	---	---	-------

Uponor Wipex mamelon fileté filet mâle

	1045455	G1	20	1	pièce
	1045456	G1 ¼-G1	20	1	pièce
	1045457	G1 ¼	15	1	pièce
	1065442	G1¼ 120mm	8	1	pièce
	1045458	G2-G1 ¼	10	1	pièce
	1045459	G2	10	1	pièce
	1065444	G2 120mm	3	1	pièce
	1045460	G3-G2	3	1	pièce
	1045461	G3	2	1	pièce

N° art.	Dimension	UL	UE	unité
---------	-----------	----	----	-------

Uponor Wipex man. pt fixe fil.m/fil.fem

	1018302	G1	30	1	pièce
	1018303	G1 ¼	10	1	pièce
	1018304	G2	5	1	pièce
	1018305	G3	5	1	pièce

Uponor Ecoflex Accouplement à souder ST PN6 EU+GOST

	1094013	25x2,3-26,9	-	1	pièce
	1094014	32x2,9-33,7	-	1	pièce
	1094015	40x3,7-42,4	-	1	pièce
	1094016	50x4,6-48,3	-	1	pièce
	1094017	63x5,8-60,3	-	1	pièce
	1094018	75x6,8-76,1	-	1	pièce
	1094019	90x8,2-88,9	-	1	pièce
	1094020	110x10,0-114,3	-	1	pièce
	1094021	125x11,4-114,3	-	1	pièce

Uponor Wipex adaptateur S-Press PN6

	1060058	32x2,9-32x3,0	25	1	pièce
--	----------------	---------------	----	---	-------

Uponor Wipex adaptateur S-Press PN6

	1060059	40x3,7-40x4,0	15	1	pièce
	1060060	50x4,6-50x4,5	10	1	pièce

Uponor Wipex pince écarteur

	1046407	1 - 1 ½	25	1	pièce
---	----------------	---------	----	---	-------

Uponor Q&E

N° art.	Dimension	UL	UE	unité
---------	-----------	----	----	-------

Uponor Q&E bague évolution white

 1057455	25	300	20	pièce
1057456	32	150	10	pièce

Uponor Q&E bague avec bord d'arrêt naturel

 1045464	40	80	5	pièce
1045489	50	70	5	pièce
1045490	63	35	5	pièce
1085087	75	18	2	pièce

Uponor Q&E coude PPSU

 1008681	25-25	25	5	pièce
1001245	32-32	10	1	pièce
1008683	40-40	10	1	pièce
1042859	50-50	5	1	pièce
1042858	63-63	3	1	pièce
1085080	75-75	2	1	pièce

Uponor Q&E manchon PPSU

 1008671	25-25	50	5	pièce
1001235	32-32	15	1	pièce
1008673	40-40	10	1	pièce
1042866	50-50	10	1	pièce
1042865	63-63	5	1	pièce
1085084	75-75	10	1	pièce

Uponor Q&E manchon réduit PPSU

 1001240	32-25	20	1	pièce
1008678	40-32	10	1	pièce
1042879	50-32	10	1	pièce
1042867	50-40	10	1	pièce
1042878	63-40	5	1	pièce
1042877	63-50	5	1	pièce
1085086	75-50	10	1	pièce
1085085	75-63	10	1	pièce

Uponor Q&E Té PPSU

 1008686	25-25-25	20	5	pièce
1001250	32-32-32	10	1	pièce
1008688	40-40-40	5	1	pièce
1042861	50-50-50	3	1	pièce
1042860	63-63-63	2	1	pièce
1085081	75-75-75	2	1	pièce

N° art.	Dimension	UL	UE	unité
---------	-----------	----	----	-------

Uponor Q&E té réduit PPSU

 1008712	25-32-25	15	1	pièce
1001426	32-25-25	15	1	pièce
1001428	32-25-32	15	1	pièce
1008713	32-40-32	10	1	pièce
1008708	40-25-32	5	1	pièce
1008695	40-25-40	5	1	pièce
1008709	40-32-32	5	1	pièce
1008696	40-32-40	5	1	pièce
1042876	50-25-40	4	1	pièce
1042864	50-25-50	4	1	pièce
1042863	50-32-50	4	1	pièce
1042862	50-40-40	4	1	pièce
1042875	50-40-50	4	1	pièce
1042871	63-25-50	2	1	pièce
1042873	63-25-63	2	1	pièce
1042870	63-32-63	2	1	pièce
1042869	63-40-40	2	1	pièce
1042872	63-40-63	2	1	pièce
1042868	63-50-50	2	1	pièce
1042874	63-50-63	2	1	pièce
1085083	75-25-75	4	1	pièce
1085082	75-40-75	4	1	pièce

Uponor Q&E raccord mâle PL

 1023007	25-R $\frac{3}{4}$ "MT	70	5	pièce
1047191	32-R1"MT	10	1	pièce

Uponor Q&E raccord male PL/DR

 1085077	40-R1 $\frac{1}{4}$ "MT	16	1	pièce
1085076	50-R1 $\frac{1}{2}$ "MT	8	1	pièce
1085075	63-R2"MT	6	1	pièce
1085074	75-R2 $\frac{1}{2}$ "MT	6	1	pièce

Uponor Q&E adapt. coudé filetage int. PL

 1023026	25-G $\frac{3}{4}$ "FT	35	5	pièce
---	------------------------	----	---	-------

Uponor Q&E raccord femelle PL

 1023012	25-Rp $\frac{3}{4}$ "FT	40	5	pièce
---	-------------------------	----	---	-------

Système de distribution Uponor Ecoflex

N° art.	Dimension	UL	UE	unité
---------	-----------	----	----	-------

Uponor Ecoflex embout terminal EPDM Single

	1018316	25+32+40/68	-	1	pièce
	1018315	25+28+32/140	-	1	pièce
	1018313	32+40+50/175	-	1	pièce
	1018314	40+50+63/140	-	1	pièce
	1095801	63+75+90/140	-	1	pièce
	1018312	63+75/175	-	1	pièce
	1018310	75+90+110/200	-	1	pièce
	1018311	90+110/175	-	1	pièce
	1067757	125/200	-	1	pièce

Uponor Ecoflex embout terminal EPDM Twin

	1119374	18-22+25-28+32/140	-	1	pièce
	1018245	25+32+40/140	-	1	pièce
	1018309	25+32+40/175	-	1	pièce
	1018308	25+32+50/175	-	1	pièce
	1018307	40+50+63/200	-	1	pièce
	1088979	75+90/250	-	1	pièce

Uponor Ecoflex embout terminal EPDM Quattro

	1018306	18-32+25-32/175	-	1	pièce
---	----------------	-----------------	---	---	-------

Uponor Ecoflex té isolé

	1060986	140/90/68	5	1	pièce
	1060982	200/175/140	4	1	pièce
NEW	1121805	200/200/175/140	3	1	pièce

Uponor Ecoflex coude

	1060985	200/175/140	3	1	pièce
---	----------------	-------------	---	---	-------

Uponor Ecoflex manchon

	1060984	200/175/140	6	1	pièce	296,87
NEW	1121806	250	4	1	pièce	356,20

N° art.	Dimension	UL	UE	unité
---------	-----------	----	----	-------

Uponor Ecoflex bague réduction

	1060991	200/68	8	1	pièce
	1085107	200/160	12	1	pièce
NEW	1121807	250/250	-	1	pièce
NEW	1121808	250/200	-	1	pièce
NEW	1121809	250/175	-	1	pièce
NEW	1122070	250/140	-	1	pièce

Uponor Ecoflex kit isolé en H (té double)

	1007355	200/175/140	-	1	pièce
---	----------------	-------------	---	---	-------

Uponor Ecoflex chambre

	1018326	6x140/145/175/200	-	3	pièce
	1018327	8x140/145/175/200	-	3	pièce
	1084576	2x250-6x140/175/200	-	1	pièce
	1084577	4x250-4x140/175/200	-	1	pièce
	1084578	6x250-2x140/175/200	-	1	pièce

Uponor Ecoflex bande trou d'inspection

	1018382	50mm x 10m	-	1	pièce
---	----------------	------------	---	---	-------

Uponor Ecoflex manchon rétractable

	1018379	140	-	1	pièce
	1018380	175/200	-	1	pièce
	1084575	250	15	1	pièce

Uponor Ecoflex coude de connexion Single

	1118767	75x6,8/140	-	1	pièce
---	----------------	------------	---	---	-------

Délai de livraison sur demande.

Uponor Ecoflex coude de connexion Twin

	1118771	2x25x2,3/140	-	1	pièce
	1118772	2x32x2,9/140	-	1	pièce
	1118773	2x40x3,7/160	-	1	pièce
	1118774	2x50x4,6/200	-	1	pièce
	1118775	2x63x5,8/200	-	1	pièce
	1118776	2x75x6,8/250	-	1	pièce

Levertijd op aanvraag.

Uponor Ecoflex bague réduction

	1085107	200/160	12	1	pièce
---	----------------	---------	----	---	-------

Système de distribution Uponor Ecoflex

N° art.	Dimension	UL	UE	unité
---------	-----------	----	----	-------

Uponor Ecoflex insert mural PWP

 1007358	68	-	1	pièce
1007360	140	-	1	pièce
1007361	175	-	1	pièce
1007362	200	-	1	pièce
1091429	250	-	1	pièce

Uponor Ecoflex insert pour traversée mur

 1007365	140	-	1	pièce
1007366	175	-	1	pièce
1007367	200	-	1	pièce
1091430	250	-	1	pièce

Uponor Ecoflex Tube de coffrage ciment

 1007368	68	-	1	pièce
1007370	140	-	1	pièce
1007371	175	-	1	pièce
1007372	200	-	1	pièce

Uponor Ecoflex kit résine époxy DWD

 1007373	1,1 kg/3,5m ²	-	1	jeu
--	--------------------------	---	---	-----

Uponor Ecoflex passage murale étanche

 1018267	68+90	-	1	pièce
1018269	140	-	1	pièce
1018268	175+200	-	1	pièce
1083871	250	16	1	pièce

Uponor Ecoflex étanchéité labyrinthe NDW

 1034202	140	40	1	pièce
1034203	175	30	1	pièce
1034204	200	20	1	pièce
1090415	250	-	1	pièce

Uponor Ecoflex Kit de réparation

 1036014	140+175+200-700mm	-	1	pièce
--	-------------------	---	---	-------

Uponor Ecoflex Ongles

 1021997		-	1	pièce	0,33
--	--	---	---	-------	------

Uponor Ecoflex Jeu de vis

 1021999	pour kit isolé en H	-	1	pièce	1,09
--	---------------------	---	---	-------	------

N° art.	Dimension	UL	UE	unité
---------	-----------	----	----	-------

Uponor Ecoflex Emballage rétractable

 1093120	160mm x 10m	30	1	pièce
--	-------------	----	---	-------

Uponor Ecoflex bande de repérage rouge

 1018385	40mm x 250m	-	1	pièce
1105785	40mm x 30m	-	1	pièce

Uponor Multi coupe-conduite

 1089677	32-40	12	1	pièce
1089779	32-40 verv.mes*	50	1	pièce

Uponor Flex Coupe-tube PEX

 1095265	50-63	12	1	pièce
1095266	50+63 verv.mes* 50	1	1	pièce

OUT Livraison dans la limite des stocks disponibles.
L'article expire au cours de l'année.

Uponor Multi coupe-conduite

 1089675	25-63	12	1	pièce
1089777	25-63 verv.mes*	50	1	pièce

Uponor Multi coupe-conduite

 1089676	50-125	8	1	pièce
1089778	50-125 verv.mes*	50	1	pièce

Uponor MLC alésoir universel

 1060167		50	1	pièce
--	--	----	---	-------

Uponor Wipex pince écarteur

 1046407	1 - 1 ½	25	1	pièce
--	---------	----	---	-------

Uponor Q&E pâte graphite

 1005017	100g	-	1	pièce
--	------	---	---	-------

Uponor Ecoflex pâte d'étanchéité

 1060996	290ml	-	1	pièce
--	-------	---	---	-------

Uponor Ecoflex jeu de vis

 1060995	M6x30 (34 pcs)	-	1	pièce
--	----------------	---	---	-------

Uponor Ecoflex Supra PLUS

 1044136	10W/m	-	1	m
--	-------	---	---	---

Outillages Uponor

N° art.	Dimension	UL	UE	unité
---------	-----------	----	----	-------

Uponor Dérouleur

Uponor MLC redresseur de tube

	1010512	14-25	60	1	pièce
---	----------------	-------	----	---	-------

Uponor Multi dérouleur

	1058662		-	1	pièce
---	----------------	--	---	---	-------

Uponor Multi dérouleur

	1006255	120-960M		-	1	pièce
---	----------------	----------	--	---	---	-------

Uponor Magna dérouleur

	1006256	25-640m		-	1	pièce
--	----------------	---------	--	---	---	-------

Uponor Magna dérouleur

	NEW 1135500		21	1	pièce	2113,96
---	--------------------	--	----	---	-------	----------------

N° art.	Dimension	UL	UE	unité
---------	-----------	----	----	-------

Uponor Découpe & préparation

Uponor Multi coupe-tube, coupe-conduite

	1089674	12-25		36	1	pièce
	1089776	12-25		150	1	pièce

Uponor Multi coupe-conduite

	1089677	32-40		12	1	pièce
	1089779	32-40	Lame de rechange	50	1	pièce

Uponor Flex Coupe-tube PEX

	OUT 1095265	50-63		12	1	pièce
	OUT 1095266	50+63	Lame de rechange	50	1	pièce

OUT: Livraison dans la limite des stocks disponibles.
L'article expire au cours de l'année.

Uponor Multi coupe-conduite

	1089675	25-63		12	1	pièce
	1089777	25-63	Molette de rechange	50	1	pièce

Uponor Multi coupe-conduite

	1089676	50-125		8	1	pièce
	1089778	50-125	Molette de rechange	50	1	pièce

Uponor Flex coupe-tube PEX

	1089673	12-25		36	1	pièce
	1089780	12-25	Lame de rechange	150	1	pièce

Uponor MLC lame pour coupe tube

	1006635	25-63		1000	1	pièce
	1014173	50-110		20	1	pièce

Uponor MLC Mallette outillage

	1014334	63-110		32	1	pièce
	1014320	63-110	Molette de rechange	100	1	pièce

Outillages Uponor

N° art. Dimension UL UE unité

Uponor Découpe & préparation

Uponor MLC ébavureuse

	1006952	14	50	1	pièce
	1006830	16	50	1	pièce
	1015749	20	1200	1	pièce
	1015756	25	960	1	pièce
	1015762	32	900	1	pièce

Uponor MLC appareil de chanfreinage

	1006638	40	600	1	pièce
	1015808	50	600	1	pièce
	1014339	63	600	1	pièce
	1014344	75	600	1	pièce

Uponor MLC ébavureuse

	1015739	16/20/25	60	1	pièce
--	----------------	----------	----	---	-------

Uponor MLC alésoir universel

	1060167		50	1	pièce
---	----------------	--	----	---	-------

Uponor MLC ressort intérieur

	1013727	14	1000	1	pièce
	1013729	16	100	1	pièce
	1013734	20	75	1	pièce
	1013737	25	50	1	pièce
	1013739	32	40	1	pièce

Uponor MLC ressort extérieur

	1006639	14	550	1	pièce
	1006640	16	55	1	pièce
	1013792	20	45	1	pièce
	1013794	25	45	1	pièce

N° art. Dimension UL UE unité

Uponor Uni Pipe PLUS cintreuse



1071925	16-32	100	1	pièce
----------------	-------	-----	---	-------

Uponor Uni Pipe PLUS segment de flexion



1120408	R32 16	10	1	pièce
1120409	R40 20	10	1	pièce
1120410	R62,5 25	10	1	pièce
1120411	R80 32	10	1	pièce

Uponor RTM calibreur



1048606	16/20/25	20	1	pièce
----------------	----------	----	---	-------

Outillages Uponor

N° art.	Dimension	UL	UE	unité
---------	-----------	----	----	-------

Outillages de sertissage

Uponor S-Press jeu d'outillage BENELUX

 1083584	16/20/25	10	1	jeu
1083585	16/20/25/32	10	1	jeu

netto installateur

Uponor S-Press outils UP110 sans mâch.

 1083612		20	1	jeu
--	--	----	---	-----

Uponor S-Press batterie UP110

 1083608		10	1	pièce
--	--	----	---	-------

Uponor S-Press chargeur batterie

 1083610	Mini2, UP110	72	1	pièce
--	--------------	----	---	-------

Uponor S-Press machine à sertir élect. UP75

 1007082		20	1	pièce
--	--	----	---	-------

Uponor S-Press mâchoire UPP1

 1007083	14	280	1	pièce
1007084	16	216	1	pièce
1007086	20	-	1	pièce
1007087	25	-	1	pièce
1007088	32	-	1	pièce

Uponor S-Press mâchoire UPP1

 1015768	40	108	1	pièce
1015792	50	108	1	pièce

Uponor S-Press mâchoire de base

 1046545	63-110	-	1	pièce
--	--------	---	---	-------

Uponor S-Press extension de mâchoire

 1046541	63	72	1	pièce
1046542	75	72	1	pièce
1046543	90	72	1	pièce
1046544	110	54	1	pièce

N° art.	Dimension	UL	UE	unité
---------	-----------	----	----	-------

Uponor S-Press outil Mini2 mâchoire KSP0

 1083586	16/20/25/32	30	1	jeu
--	-------------	----	---	-----

netto installateur

Uponor S-Press outil Mini2 mâch. KSP0

 1083594	16/20/25	25	1	jeu
--	----------	----	---	-----

netto installateur

Uponor S-Press mâchoire Mini KSP0

 1007090	14	5	1	pièce
1007091	16	5	1	pièce
1007093	20	5	1	pièce
1007094	25	5	1	pièce
1007095	32	5	1	pièce

Net installateur

Uponor S-Press batterie Minipipe 32

 1083605		48	1	pièce
--	--	----	---	-------

netto installateur

Uponor S-Press chargeur batterie

 1083610	Mini2, UP110	72	1	pièce
--	--------------	----	---	-------

Uponor S-Press pince man. sans insert

 1015764	14-20	100	1	pièce
--	-------	-----	---	-------

Uponor S-Press insert pince manuelle

 1015776	14	400	1	pièce
1015777	16	50	1	pièce
1015780	20	50	1	pièce

Uponor S-Press sertisseuse manuelle BENELUX

 1013778	14-20	20	1	pièce
--	-------	----	---	-------

Net installateur

Outillages Uponor

N° art.	Dimension	UL	UE	unité
---------	-----------	----	----	-------

Outillages d'expansion

Uponor Minitec outil d'expansion

	1006247	9,9x1,1	11	1	jeu
---	----------------	---------	----	---	-----

Uponor Q&E outil d'expansion avec tête M12

	OUT 1063112	6bar 9,9/20	-	1	jeu
	OUT 1057166	16/20/25 6bar	-	1	jeu
	OUT 1057167	16/20/25 10bar	-	1	jeu

Uponor Q&E Outil d'évasement avec évasement c. M12/

	1119375	6bar 9,9RS/20	-	1	jeu
	1119376	16RS/20/25 6bar	-	1	jeu
	1119379	16RS/20/25 10bar	-	1	jeu

Uponor Q&E Tête d'expansion M12/Rapid Seal

	1119380	9,9x1,1	-	1	pièce
---	----------------	---------	---	---	-------

Uponor Q&E tête d'expansion M12/M18

	1057171	12x1,1/1,7/1,8/2,0	-	1	pièce
	1057184	14/15x2,5	-	1	pièce
	OUT 1057172	16x1,8/2,0/2,2	-	1	pièce
	1057185	17/18x2,5	-	1	pièce
	OUT 1057173	20x1,9/2,0	-	1	pièce
	OUT 1057175	25x2,3	-	1	pièce
	OUT 1057176	25x3,5	-	1	pièce
	OUT 1057177	32x2,9	-	1	pièce

OUT Livraison dans la limite des stocks disponibles.
L'article expire au cours de l'année.

Uponor Q&E Tête d'expansion M12/M18/Rapid Seal

	1119381	16x1,8/2,0/2,2	-	1	pièce
	1119382	20x1,9/2,0	-	1	pièce
	1119383	20x2,8	-	1	pièce
	1119384	25x2,3	-	1	pièce
	1119385	25x3,5	-	1	pièce
	1119386	32x2,9	-	1	pièce

N° art.	Dimension	UL	UE	unité
---------	-----------	----	----	-------

Uponor Q&E accu rempl. outil d'exp. M12

	1061185	4Ah	12	1	pièce
---	----------------	-----	----	---	-------

Uponor Q&E outil d'expansion avec tête M18 6bar

	1063908	16/20/25/32	-	1	jeu
---	----------------	-------------	---	---	-----

Uponor Q&E outil d'expansion avec tête M18 10bar

	1063909	16/20/25/H32	-	1	jeu
---	----------------	--------------	---	---	-----

Uponor Q&E tête d'expansion M18 H

	1057182	32x2,9/4,4	-	1	pièce
	1057183	40x3,7	-	1	pièce

Uponor Q&E outil d'expansion M18 VLD PEX

	1085099	40-75	-	1	pièce
---	----------------	-------	---	---	-------

Uponor Q&E tête d'expansion VLD

	1085095	40x3,7/5,5	-	1	pièce
	1085096	50x4,6/6,9	-	1	pièce
	1085097	63x5,8/8,6	-	1	pièce
	1085098	75x6,8/10,3	-	1	pièce

Uponor Q&E batterie outil expansion M18 PEX

	1085100	5,0Ah	-	1	pièce
---	----------------	-------	---	---	-------

Uponor Q&E chargeur outil expansion M12/M18 PEX

	1085101	220-240V/50-60Hz	-	1	pièce
---	----------------	------------------	---	---	-------

Uponor Q&E pâte graphite

	1005017	100g	-	1	pièce
---	----------------	------	---	---	-------

Outillages Uponor

N° art.	Dimension	UL	UE	unité
---------	-----------	----	----	-------

Uponor fixation

Uponor Siccus 14 cutter à polystyrène



1006290	14mm 230V	20	1	pièce
----------------	-----------	----	---	-------

Uponor Tacker outil



1119039	14-20mm	50	1	pièce
----------------	---------	----	---	-------

Uponor Multi rouleau de ruban adhésif



1000142		20	1	pièce
----------------	--	----	---	-------

Uponor Classic Clipmaster



1006295	16/17mm l=920mm	100	1	pièce
----------------	-----------------	-----	---	-------

1006309	20mm l=920mm	-	1	pièce
----------------	--------------	---	---	-------

Uponor Classic outil tordage



1006243	l=320mm	50	1	pièce
----------------	---------	----	---	-------

Uponor Multi support de tube



1088066		-	1	pièce
----------------	--	---	---	-------

N° art.	Dimension	UL	UE	unité
---------	-----------	----	----	-------

Uponor autres

Uponor Rapex tête à sertir



1006330	14x2	-	1	pièce
----------------	------	---	---	-------

1006332	16x2	8	1	pièce
----------------	------	---	---	-------

1006343	17x2	-	1	pièce
----------------	------	---	---	-------

Uponor Smart Aqua sup. de mont. outil de cintr.



1015424	2m	100	1	pièce
----------------	----	-----	---	-------

Télécharger la liste de prix en ligne complète:



Directement vers le téléchargement de la liste de prix complète Benelux 2023 (uniquement disponible en version PDF).

Remarques relatives au tarif actuel

- À défaut d'indications autres, tous les prix sont bruts, sont libellés en € (euros) et s'entendent hors T.V.A.
- Nos conditions de vente et de livraison s'appliquent à tous les produits.
- Ce tarif remplace toutes les éditions précédentes.
- Les prix s'entendent hors usine, à l'exclusion de l'emballage de transport.
- Sous réserve de modifications techniques et en termes de contenu.
- Pour plus d'informations, veuillez consulter les sites web
www.uponor.nl / www.nathan.nl ou
www.uponor.be / www.nathan.be

Toutes les informations légales et techniques ont été compilées avec le plus grand soin possible. Les erreurs ne peuvent cependant pas être totalement exclues et aucune responsabilité ne sera acceptée à cet égard. Tous les éléments de ce document sont protégés par des droits d'auteur. Toute utilisation sauf exceptions autorisées par les droits d'auteur, sans l'autorisation d'Uponor GmbH est interdite. Sous réserve de modifications techniques.

© 2023

Uponor GmbH, Haßfurt

Moving > Water

Uponor

Uponor GmbH

Industriestraße 56

97437 Hassfurt

Germany

www.uponor.com



Nathan Systems NV/SA

Lozenberg 4

1932 Zaventem

België

T +32 (0)2 721 15 70

F +32 (0)2 725 35 53

W www.nathan.be

E info@nathan.be

W www.uponor.be

E info.be@uponor.com

Nathan Systems BV

Mega 2

6902 KL, Zevenaar

Nederland

T +31 (0)26-445 98 45

F +31 (0)26-445 93 73

W www.nathan.nl

E info@nathan.nl

W www.uponor.nl

E info.nl@uponor.com