

Oppervlakteverwarming en -koeling, installatie-, warmte- en koudedistributiesystemen

Uponor

Verkorte artikellijst Benelux 01-2023

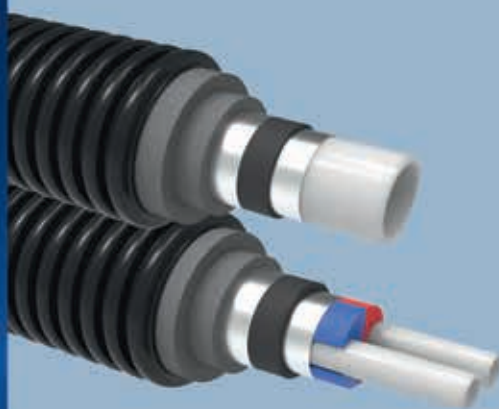

Uponor verkorte artikellijst 2023 Benelux

Installatie

Meerlagenleidingsystemen voor drinkwater en verwarmingsinstallatie

Overzicht	4
Uponor meerlagenleidingen	6
Uponor S-Press PLUS	8
Uponor RTM	17
Uponor Uni-X klemkoppelingen 3/4"	19
Uponor RS 63-110 mm	23

Meerlagenleidingsystemen voor gasinstallatie

Uponor GAS Press	20
------------------------	----

PE-Xa installatiesystemen voor drinkwater en verwarmingsinstallatie

Uponor leidingen PE-Xa	24
Uponor fittingen Q&E	25
Uponor Aqua PLUS verdeler PPM	28

PE-Xa installatiesystemen voor gasinstallatie

Uponor PE-Xa gasleidingsysteem	29
--------------------------------------	----

Oppervlakteverwarming- en koelsystemen

Oppervlakteverwarming-/koelsystemen via vloer, wand en plafond

Overzicht Uponor systemen	30
Overzicht Uponor leidingen	32

Oppervlakteverwarmingssystemen

Uponor 10 bar UFH vloerverwarming	34
Uponor Minitec	35
Uponor Tecto	36
Uponor Tecto	37
Uponor Nubos	38
Uponor Klett	39
Uponor Tacker	41
Uponor Fix	43
Uponor Classic	44
Uponor Siccus 14	45
Uponor Renovis	46
Uponor Comfort E	47
Uponor Siccus wall	48
Uponor Thermatop	49

Toebehoren voor oppervlakteverwarmingssystemen	50
--	----

Uponor verdeel- en stijgleidingen 25-75 mm	51
--	----

Verdelertechniek

Uponor stelaandrijvingen en -adapters	52
Uponor Vario PLUS	53
Uponor Vario M	54
Uponor Vario S	54
Uponor Vario	58

Ruimtetemperatuurregeling

Systeemzoeker Uponor ruimteregeling	58
Uponor Smatrix Wave / Pulse	61
Uponor Smatrix Base / Pulse	62
Uponor Smatrix Base PRO	63
Uponor Base	64
Uponor Vario	64

Aanvoertemperatuurregeling / pompgroepen

Uponor Smatrix Move PRO	65
Uponor Fluvia Move pompgroep	67

Warmte- en koudedistributie

Overzicht Uponor Ecoflex	68-71
--------------------------------	-------

Voorgeïsoleerde leidingen Uponor Ecoflex

Uponor Ecoflex VIP Thermo	72
Uponor Ecoflex Thermo	72
Uponor Ecoflex VIP Aqua	73
Uponor Ecoflex Aqua	73
Uponor Ecoflex Quattro	74
Uponor Ecoflex Supra	74
Uponor Ecoflex Supra PLUS	74

Koppelingen

Uponor Wipex	75
Uponor Q&E	77

Toebehoren voor Ecoflex leidingsystemen	79
---	----

Gereedschappen

Verleggen	80
Vorbereiden, snijden, buigen	80
Persen	82
Expanderen	83
Bevestigen	84

Installatie

Meerlagenleidingsystemen voor drinkwater-, verwarmings- en gasinstallatie

PE-Xa installatiesystemen voor drinkwater-, verwarmings- en gasinstallatie



Installatie

Oppervlakteverwarming-/-koelsystemen

Oppervlakteverwarming-/-koelsystemen via vloer, wand en plafond
Verdelertechniek
Ruimtetemperatuurregeling
Regeling van de aanvoertemperatuur / pompgroepen



Verwarming
en koeling

Warmte- en koudedistributie

Voorgeïsoleerde leidingen voor distributie van verwarmings- en koelwater

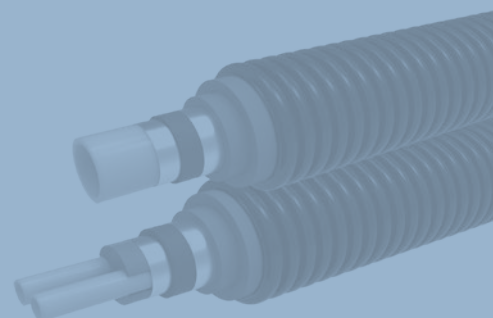

Warmte- en
koudedistributie

Gereedschappen

Verleggen, voorbereiden, snijden, buigen persen, expanderen, bevestigen, overige

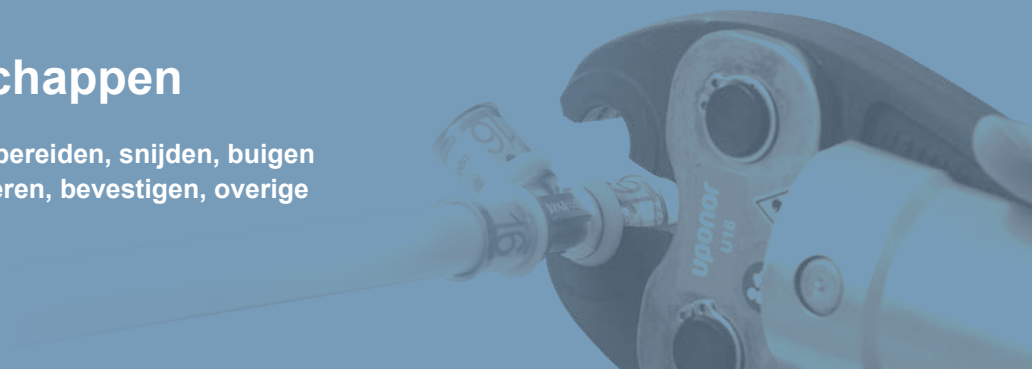

Gereedschappen

Bijlage











Bijlage

Overzicht Uponor installatieleidingen en

Verschillende montagesituaties en toepassingsgebieden verlangen perfect daarop afgestemde fittingconcepten. Daarom ontwikkelt en produceert Uponor niet alleen leidingen, maar tegelijkertijd ook de passende, perfect op de toepassing afgestemde fittingsystemen. Het Uponor fittingprogramma met koppelingen, knieën, bochten, T-stukken en diverse handige systeemcomponenten garandeert een snelle, veilige en doeltreffende montage en overstijgt daarbij de eisen die aan een hygiënische drinkwaterinstallatie en hedendaagse verwarmingsleidingen worden gesteld.

Uponor fittingsysteem

Afmeting/ Kleurcode	Type meerlagenleiding
------------------------	--------------------------

 14	MLC
 16	Uni Pipe PLUS
 20	Uni Pipe PLUS
 25	Uni Pipe PLUS
 32	Uni Pipe PLUS
 40	MLC
 50	MLC
 63	MLC
 75	MLC
 90	MLC
 110	MLC

Eigenschappen

Per diameter een kleurcodering

Kijkvenster ter controle van de insteekdiepte

Controle op persing
door het verwijderen van de folie van de pershuls

Controle op persing
door de aanslagring die loslaat tijdens de persprocedure

Controle op persing
door persafdruk op pershuls

Montage zonder ontbramen

Montage zonder kalibreren

Verbindingsstuk 'ongeperst niet dicht'

Geïntegreerde persfunctie

Modulair fittingsysteem

Uponor Uni Pipe PLUS

art.nr.	omschrijving	LE	VPE	eenheid
---------	--------------	----	-----	---------

Uponor Uni Pipe PLUS wit S

 1060783	16x2,0 3m	75	3	m
1059572	16x2,0 5m	125	5	m
1060784	20x2,25 3m	51	3	m
1059573	20x2,25 5m	85	5	m
1060785	25x2,5 3m	30	3	m
1059574	25x2,5 5m	50	5	m
1060786	32x3,0 3m	21	3	m
1059575	32x3,0 5m	35	5	m

Uponor MLC leiding wit S

 1013448	40x4,0 3m	12	3	m
1088465	40x4,0 3,3m	13,2	3,3	m
1013446	40x4,0 5m	20	5	m
1021980	50x4,5 3m	12	3	m
1013449	50x4,5 5m	20	5	m
1021981	63x6,0 3m	9	3	m
1013451	63x6,0 5m	15	5	m
1013453	75x7,5 5m	255	5	m
1013455	90x8,5 5m	255	5	m
1013457	110x10,0 5m	165	5	m

Uponor Uni Pipe PLUS wit

 1091638	16x2,0 10m	880	220	m
1091639	16x2,0 25m	1600	400	m
1059576	16x2,0 100m	2000	100	m
1092653	16x2,0 120m	2400	120	m
1059577	16x2,0 200m	2600	200	m
1059578	16x2,0 500m	3500	500	m
1092671	20x2,25 25m	900	225	m
1059579	20x2,25 100m	1300	100	m
1093124	20x2,25 500m	2000	500	m
1059581	25x2,5 50m	700	50	m
1059583	32x3,0 50m	400	50	m

Uponor MLC leiding wit

 1013366	14x2,0 200m	2600	200	m
--	-------------	------	-----	---

art.nr.	omschrijving	LE	VPE	eenheid
---------	--------------	----	-----	---------

Uponor Uni Pipe PLUS wit voorgeïsoleerd S4 WLS 040

 1091709	16x2,0 red	800	100	m
1063553	16x2,0 blue	800	100	m
1091710	20x2,25 red	800	100	m
1063555	20x2,25 blue	800	100	m
1091711	25x2,5 red	400	50	m
1063946	25x2,5 blue	400	50	m
1091712	32x3,0 red	350	50	m
1091716	32x3,0 blue	350	50	m

Uponor MLC leiding wit voorgeïsoleerd S6

 1013577	14x2,0 red	600	50	m
--	------------	-----	----	---

Uponor Uni Pipe PLUS wit voorgeïsoleerd S6 WLS 035

 1063556	16x2,0 blue	600	75	m
1063557	20x2,25 blue	600	75	m
1063558	25x2,5 blue	400	50	m

Uponor Uni Pipe PLUS wit voorgeïsoleerd S6 WLS 040

 1091713	16x2,0 red	600	75	m
1091714	20x2,25 red	600	75	m
1091715	25x2,5 red	400	50	m
1091723	16x2,0 blue	600	75	m
1091724	20x2,25 blue	600	75	m
1091725	25x2,5 blue	400	50	m

Uponor Uni Pipe PLUS wit voorgeïsoleerd S10 WLS 035

 1062181	16x2,0 blue	450	75	m
1062182	20x2,25 blue	525	75	m
1062183	25x2,5 blue	350	50	m

Uponor Uni Pipe PLUS wit voorgeïsoleerd DHS26

 1063562	20x2,25 blue	200	25	m
--	--------------	-----	----	---

Uponor Uni Pipe PLUS

art.nr.	omschrijving	LE	VPE	eenheid	prijs/eenheid
---------	--------------	----	-----	---------	---------------

Uponor Uni Pipe PLUS wit in mantelbuis

 1063061	16x2,0 - 25/20 red	1350	75	m	
1063059	16x2,0 - 25/20 blue	1350	75	m	
1063062	20x2,25 - 28/23 red	900	75	m	
1063060	20x2,25 - 28/23 blue	900	75	m	
1093128	25x2,5 - 40/32 red	450	50	m	
1093129	25x2,5 - 40/32 blue	450	50	m	

Uponor Uni Pipe PLUS in mantelbuis twin

 1091718	16x2,0 - 25/20 black	650	50	m	
--	----------------------	-----	----	---	--

Uponor MLC leiding wit in mantelbuis

 1013678	14x2,0 - 25/20 red	1500	75	m	
--	--------------------	------	----	---	--

art.nr.	omschrijving	LE	VPE	eenheid
---------	--------------	----	-----	---------

Uponor Teck mantelbuis zwart black

 1012860	25/20	2500	50	m
1012864	28/23	2000	50	m
1012869	35/29	1400	50	m
1012872	43/36	600	25	m

Uponor Teck mantelbuis blauw blue

 1012859	25/20	2500	50	m
1012863	28/23	2000	50	m
1012867	35/29	1400	50	m

Uponor Teck mantelbuis rood red

 1012858	25/20	2500	50	m
1012862	28/23	2000	50	m
1012866	35/29	1400	50	m

Uponor Teck plughaken enkel

 NEW	1135511	32	1600	200	st.
NEW	1135512	32	1600	200	st.

Uponor Teck plughaken dubbel

 NEW	1135513	32	1200	200	st.
NEW	1135514	32	800	200	st.

Uponor S-Press PLUS PPSU

art.nr.	omschrijving	LE	VPE	eenheid
---------	--------------	----	-----	---------

Uponor S-Press PLUS knie 90° PPSU

 1039929	16-16	80	20	st.
1039930	20-20	80	10	st.
1039931	25-25	80	10	st.
1039932	32-32	20	5	st.

Uponor S-Press composiet knie 90° PPSU

 1046386	40-40	960	5	st.
1046387	50-50	576	3	st.
1032877	63-63	210	1	st.
1032878	75-75	210	1	st.

Uponor S-Press composiet knie 45° PPSU

 1046388	40-40	960	5	st.
1046389	50-50	576	3	st.
1032879	63-63	192	1	st.
1032880	75-75	192	1	st.

Uponor S-Press PLUS koppeling PPSU

 1039933	16-16	80	20	st.
1039934	20-20	80	10	st.
1039935	25-25	80	10	st.
1039936	32-32	80	10	st.

Uponor S-Press composiet koppeling PPSU

 1046401	40-40	960	5	st.
1046402	50-50	576	3	st.
1032881	63-63	384	1	st.
1032882	75-75	384	1	st.

Uponor S-Press PLUS koppeling verlopend PPSU

 1039937	20-16	80	20	st.
1039938	25-16	80	10	st.
1039939	25-20	80	10	st.
1039940	32-25	80	10	st.

Uponor S-Press koppeling verlopend PPSU

 1039941	40-25	960	5	st.
1039942	40-32	960	5	st.
1039943	50-32	1152	3	st.
1046406	50-40	576	3	st.
1032883	63-40	384	1	st.
1032884	63-50	384	1	st.
1032885	75-50	384	1	st.
1032886	75-63	384	1	st.

art.nr.	omschrijving	LE	VPE	eenheid
---------	--------------	----	-----	---------

Uponor S-Press PLUS T-stuk PPSU

 1039944	16-16-16	80	10	st.
1039945	20-20-20	80	10	st.
1039946	25-25-25	20	5	st.
1039947	32-32-32	20	5	st.

Uponor S-Press composiet T-stuk PPSU

 1046390	40-40-40	720	5	st.
1046391	50-50-50	288	3	st.
1032887	63-63-63	150	1	st.
1032888	75-75-75	150	1	st.

Uponor S-Press PLUS T-stuk verlopend PPSU

 1039948	16-20-16	80	10	st.
1039949	20-16-16	80	10	st.
1039950	20-16-20	80	10	st.
1039951	20-20-16	80	10	st.
1039952	20-25-20	80	10	st.
1039953	25-16-16	80	10	st.
1039954	25-16-20	80	10	st.
1039955	25-16-25	80	10	st.
1039956	25-20-20	80	10	st.
1039957	25-20-25	80	10	st.
1039958	32-16-32	20	5	st.
1039959	32-20-32	20	5	st.
1039960	32-25-25	20	5	st.
1039961	32-25-32	20	5	st.

Uponor S-Press T-stuk verlopend PPSU

 1039962	40-20-40	960	5	st.
1039963	40-25-32	960	5	st.
1039964	40-25-40	720	5	st.
1039965	40-32-32	960	5	st.
1039966	40-32-40	720	5	st.
1039967	50-25-40	432	3	st.
1039968	50-25-50	432	3	st.
1039969	50-32-50	432	3	st.

Uponor S-Press composiet T-stuk verlopend PPSU

 1046400	50-40-50	288	3	st.
1032889	63-25-63	150	1	st.
1032890	63-32-63	150	1	st.
1032891	63-40-63	150	1	st.
1032892	75-32-75	150	1	st.
1032893	75-40-75	150	1	st.
1032894	75-50-75	150	1	st.

Uponor S-Press PLUS 14

art.nr.	omschrijving	LE	VPE	eenheid	prijs/eenheid
---------	--------------	----	-----	---------	---------------

Uponor S-Press puntstuk

 1014513	14-R $\frac{1}{2}$ "MT	80	20	st.	
--	------------------------	----	----	-----	--

Uponor S-Press schroefbus

 1014515	14-Rp $\frac{1}{2}$ "FT	80	20	st.	
--	-------------------------	----	----	-----	--

Uponor S-Press knie 90°

 NEW 1133445	14-14	80	20	st.	9,60
---	-------	----	----	-----	-------------

Uponor S-Press koppeling

 1015154	14-14	80	10	st.	
--	-------	----	----	-----	--

Uponor S-Press koppeling verlopend

 1015162	16-14	80	20	st.	
--	-------	----	----	-----	--

Uponor S-Press T-stuk

 1014886	14-14-14	80	10	st.	
--	----------	----	----	-----	--

Uponor S-Press T-stuk verlopend

 1014888	14-16-14	80	10	st.	
1014912	16-14-14	80	10	st.	
1014915	16-14-16	80	10	st.	

art.nr.	omschrijving	LE	VPE	eenheid
---------	--------------	----	-----	---------

Uponor S-Press koppeling overgangskoppeling koper/RVS

 1014511	14-15CU	80	10	st.
--	---------	----	----	-----

Uponor Smart Aqua muurplaat S-Press

 1015437	14-Rp $\frac{1}{2}$ "FT	40	10	st.
--	-------------------------	----	----	-----

Uponor S-Press muurplaat twin 90° long

 NEW 1133446	14-Rp $\frac{1}{2}$ "FT-14	40	10	st.
---	----------------------------	----	----	-----

Uponor Smart Aqua overgangsknie S-Press

 1014654	14-12CU l=150mm	2880	20	st.
---	-----------------	------	----	-----

Uponor Smart Radi aansluitknie S-Press

 1015615	14-15CU l=350mm	640	20	st.
--	-----------------	-----	----	-----

Uponor S-Press PLUS

art.nr.	omschrijving	LE	VPE	eenheid
---------	--------------	----	-----	---------

Uponor S-Press PLUS puntstuk

	1070501 16-R $\frac{3}{8}$ "MT	80	20	st.
	1070502 16-R $\frac{1}{2}$ "MT	80	20	st.
	1070503 16-R $\frac{3}{4}$ "MT	120	15	st.
	1070504 20-R $\frac{1}{2}$ "MT	80	20	st.
	1070505 20-R $\frac{3}{4}$ "MT	80	10	st.
	1070506 20-R1"MT	80	10	st.
	1070507 25-R $\frac{3}{4}$ "MT	80	10	st.
	1070508 25-R1"MT	40	5	st.
	1070509 32-R1"MT	40	5	st.
	1070510 32-R1 $\frac{1}{4}$ "MT	20	5	st.

Uponor S-Press puntstuk

	1046901 40-R1 $\frac{1}{4}$ "MT	960	5	st.
	1046902 40-R1 $\frac{1}{2}$ "MT	960	5	st.
	1046905 50-R1 $\frac{1}{2}$ "MT	1152	3	st.
	1046906 50-R2"MT	576	3	st.
	1032895 63-R2"MT	336	1	st.
	1032896 75-R2 $\frac{1}{2}$ "MT	336	1	st.

Uponor S-Press PLUS overgangskoppeling BENELUX

	1070511 16-R15mm CU	80	20	st.
	1070512 20-R22mm CU	3840	10	st.
	1070513 25-R22mm CU	3840	10	st.

Uponor S-Press PLUS schroefbus

	1070515 16-Rp $\frac{1}{2}$ "FT	80	20	st.
	1070516 20-Rp $\frac{1}{2}$ "FT	120	15	st.
	1070517 20-Rp $\frac{3}{4}$ "FT	80	10	st.
	1070518 20-Rp1"FT	80	20	st.
	1070519 25-Rp $\frac{3}{4}$ "FT	40	5	st.
	1070520 25-Rp1"FT	40	5	st.
	1070521 32-Rp1"FT	40	5	st.
	1070522 32-Rp1 $\frac{1}{4}$ "FT	20	5	st.

Uponor S-Press schroefbus

	1046903 40-Rp1 $\frac{1}{4}$ "FT	960	5	st.
	1046904 40-Rp1 $\frac{1}{2}$ "FT	960	5	st.
	1046907 50-Rp1 $\frac{1}{2}$ "FT	1152	3	st.

Uponor S-Press PLUS knie 90°

	1070523 16-16	80	20	st.
	1070524 20-20	80	10	st.
	1070525 25-25	40	5	st.
	1070526 32-32	20	5	st.

art.nr.	omschrijving	LE	VPE	eenheid
---------	--------------	----	-----	---------

Uponor S-Press knie 90°

	1046908 40-40	600	5	st.
	1046911 50-50	240	3	st.

Uponor S-Press PLUS bocht 90°

	1070527 16-16	80	10	st.
	1070528 20-20	80	10	st.
	1070529 25-25	40	5	st.
	1070530 32-32	20	5	st.

Uponor S-Press PLUS knie 90° buitendraad

	1070531 16-R $\frac{3}{8}$ "MT	80	20	st.
	1070532 16-R $\frac{1}{2}$ "MT	80	20	st.
	1070533 20-R $\frac{1}{2}$ "MT	80	10	st.
	1070534 20-R $\frac{3}{4}$ "MT	80	10	st.
	1070535 25-R $\frac{3}{4}$ "MT	40	5	st.
	1070536 25-R1"MT	40	5	st.
	1070537 32-R1"MT	20	5	st.

Uponor S-Press knie 90° buitendraad

	1046909 40-R1 $\frac{1}{4}$ "MT	500	5	st.
---	--	-----	---	-----

Uponor S-Press PLUS kniekoppeling klemovergang koper

	1070538 16-G $\frac{3}{8}$ "MT/10CU	20	1	st.
---	--	----	---	-----

Uponor S-Press PLUS knie 90° binnendraad

	1070539 16-Rp $\frac{1}{2}$ "FT	80	10	st.
	1070540 20-Rp $\frac{1}{2}$ "FT	80	10	st.
	1070541 20-Rp $\frac{3}{4}$ "FT	40	10	st.
	1070542 25-Rp $\frac{3}{4}$ "FT	20	5	st.
	1070543 25-Rp1"FT	20	5	st.
	1070544 32-Rp1"FT	20	5	st.

Uponor S-Press knie 90° binnendraad

	1046910 40-Rp1 $\frac{1}{2}$ "FT	500	5	st.
	1046912 50-Rp1 $\frac{1}{2}$ "FT	300	3	st.

Uponor S-Press PLUS

art.nr.	omschrijving	LE	VPE	eenheid	prijs/eenheid
---------	--------------	----	-----	---------	---------------

Uponor S-Press PLUS knie 45°

 1070545	25-25	20	5	st.	
1070546	32-32	20	5	st.	

Uponor S-Press knie 45°

 1046913	40-40	500	5	st.	
1046914	50-50	300	3	st.	

Uponor S-Press PLUS koppeling

 1070547	16-16	80	20	st.	
1070548	20-20	80	10	st.	
1070549	25-25	80	10	st.	
1070550	32-32	40	5	st.	

Uponor S-Press PLUS schuifkoppeling

 1118706	16-16	80	10	st.	
1118707	20-20	80	10	st.	
1118708	25-25	40	5	st.	
1118709	32-32	20	5	st.	
1118710	40-40	12	3	st.	

Uponor S-Press koppeling

 1046932	40-40	960	5	st.	
1046935	50-50	576	3	st.	

Uponor S-Press PLUS koppeling verlopend

 1070552	20-16	80	20	st.	
1070553	25-16	80	10	st.	
1070554	25-20	80	10	st.	
1070555	32-20	80	10	st.	
1070556	32-25	80	10	st.	

Uponor S-Press koppeling verlopend

 1046930	40-25	960	5	st.	
1046931	40-32	960	5	st.	
1046933	50-32	1152	3	st.	
1046934	50-40	576	3	st.	

art.nr.	omschrijving	LE	VPE	eenheid
---------	--------------	----	-----	---------

Uponor S-Press PLUS T-stuk

 1070560	16-16-16	80	10	st.
1070561	20-20-20	80	10	st.
1070562	25-25-25	20	5	st.
1070563	32-32-32	20	5	st.

Uponor S-Press T-stuk

 1046921	40-40-40	400	5	st.
1046928	50-50-50	300	3	st.

Uponor S-Press PLUS T-stuk verlopend

 1070566	16-20-16	80	10	st.
1070567	20-16-16	40	10	st.
1070568	20-16-20	80	20	st.
1070569	20-20-16	80	20	st.
1070570	20-25-16	40	10	st.
1070571	20-25-20	40	10	st.
1070572	25-16-16	40	5	st.
1070573	25-16-20	40	5	st.
1070574	25-16-25	20	5	st.
1070575	25-20-16	40	5	st.
1070576	25-20-20	40	5	st.
1070577	25-20-25	20	5	st.
1070578	25-25-16	20	5	st.
1070579	25-32-25	20	5	st.
1070580	32-16-32	20	5	st.
1070581	32-20-32	20	5	st.
1070582	32-25-25	20	5	st.
1070583	32-25-32	20	5	st.

Uponor S-Press T-stuk verlopend

 1046916	40-20-40	400	5	st.
1046917	40-25-32	500	5	st.
1046918	40-25-40	400	5	st.
1046919	40-32-32	400	5	st.
1046920	40-32-40	400	5	st.
1046924	50-25-40	300	3	st.
1046925	50-25-50	240	3	st.
1046926	50-32-50	300	3	st.
1046927	50-40-50	300	3	st.

Uponor S-Press PLUS T-stuk buitendraad

 1070592	16-R $\frac{1}{2}$ \"MT-16	40	10	st.
1070593	25-R $\frac{3}{4}$ \"MT-25	20	5	st.
1070594	32-R $\frac{3}{4}$ \"MT-32	20	5	st.

Uponor S-Press PLUS

art.nr.	omschrijving	LE	VPE	eenheid
---------	--------------	----	-----	---------

Uponor S-Press PLUS T-stuk binnendraad

	1070595 16-Rp $\frac{1}{2}$ "FT-16	40	10	st.
	1070596 20-Rp $\frac{1}{2}$ "FT-20	60	15	st.
	1070597 20-Rp $\frac{3}{4}$ "FT-20	40	10	st.
	1070598 25-Rp $\frac{1}{2}$ "FT-25	20	5	st.
	1070599 25-Rp $\frac{3}{4}$ "FT-25	20	5	st.
	1070600 32-Rp $\frac{1}{2}$ "FT-32	20	5	st.
	1070601 32-Rp $\frac{3}{4}$ "FT-32	20	5	st.

Uponor S-Press T-stuk binnendraad

	1046922 40-Rp $\frac{1}{2}$ "FT-40	500	5	st.
	1046923 40-Rp $\frac{3}{4}$ "FT-40	400	5	st.
	1046929 50-Rp1"FT-50	240	3	st.

Uponor S-Press PLUS schroefkoppeling met wartel binnendraad

	1070708 16-G $\frac{3}{8}$ "SN	25	1	st.
	1070602 16-G $\frac{1}{2}$ "SN	30	1	st.
	1070603 16-G $\frac{3}{4}$ "SN	20	1	st.
	1070604 20-G $\frac{1}{2}$ "SN	20	1	st.
	1070605 20-G $\frac{3}{4}$ "SN	20	1	st.
	1070606 25-G $\frac{3}{4}$ "SN	15	1	st.
	1070607 25-G1"SN	15	1	st.
	1070608 25-G1 $\frac{1}{4}$ „SN	10	1	st.
	1070609 32-G1"SN	10	1	st.
	1070610 32-G1 $\frac{1}{4}$ "SN	10	1	st.

Uponor S-Press schroefkoppeling met wartel binnendraad

	1060094 40-G1 $\frac{1}{4}$ "SN	960	5	st.
	1046937 40-G1 $\frac{1}{2}$ "SN	960	5	st.
	1060095 50-G1 $\frac{1}{2}$ "SN	1152	3	st.
	1046938 50-G1 $\frac{3}{4}$ "SN	1152	3	st.
	1046939 50-G2"SN	576	3	st.

Uponor S-Press PLUS knie koppeling met wartel binnendraad

	1070611 16-G $\frac{3}{8}$ "SN	20	1	st.
	1070612 16-G $\frac{1}{2}$ "SN	20	1	st.
	1105818 16-G $\frac{3}{4}$ "SN	10	1	st.
	1070613 20-G $\frac{1}{2}$ "SN	20	1	st.
	1105819 20-G $\frac{3}{4}$ "SN	10	1	st.
	1070614 25-G $\frac{3}{4}$ "SN	10	1	st.

art.nr.	omschrijving	LE	VPE	eenheid
---------	--------------	----	-----	---------

Uponor S-Press PLUS muurplaat M

	1070638 16-Rp $\frac{3}{8}$ "FT	40	10	st.
	1070639 16-Rp $\frac{1}{2}$ "FT	40	10	st.
	1070640 20-Rp $\frac{1}{2}$ "FT	40	10	st.
	1070641 20-Rp $\frac{3}{4}$ "FT	20	5	st.
	1070642 25-Rp $\frac{3}{4}$ "FT	20	5	st.

Uponor S-Press PLUS muurplaat lang L

	1070644 16-Rp $\frac{1}{2}$ "FT	40	10	st.
	1070645 20-Rp $\frac{1}{2}$ "FT	40	10	st.

Uponor S-Press PLUS muurplaat XL

	1070646 16-Rp $\frac{1}{2}$ "FT	40	10	st.
	1070647 20-Rp $\frac{1}{2}$ "FT	40	10	st.

Uponor S-Press PLUS geluidsset 2 muurplaten

	1121193 16-20	192	1	set
--	----------------------	-----	---	-----

Uponor S-Press PLUS wandrozet muurplaat

	1070643 16-Rp $\frac{3}{4}$ "FT	20	1	st.
---	--	----	---	-----

Uponor S-Press PLUS muurplaat Gemini

	1070665 16-Rp $\frac{1}{2}$ "FT	4800	75	st.
---	--	------	----	-----

Uponor S-Press PLUS U-muurplaat

	1070629 16-Rp $\frac{1}{2}$ "FT-16	20	5	st.
	1070630 20-Rp $\frac{1}{2}$ "FT-20	960	5	st.
	1070631 20-Rp $\frac{1}{2}$ "FT-16	960	5	st.
	1070632 16-Rp $\frac{1}{2}$ "FT-20	960	5	st.
	1070633 25-Rp $\frac{1}{2}$ "FT-25	576	3	st.
	1070634 25-Rp $\frac{1}{2}$ "FT-20	576	3	st.
	1070635 20-Rp $\frac{1}{2}$ "FT-25	576	3	st.

Uponor S-Press PLUS geluidsset U-muurpaneel

	1121194 16-20	384	1	st.
---	----------------------	-----	---	-----

Uponor S-Press PLUS

art.nr.	omschrijving	LE	VPE	eenheid	prijs/eenheid
---------	--------------	----	-----	---------	---------------

Uponor S-Press PLUS U-aansluiting

 1070636	16-16-R $\frac{1}{2}$ "MT	960	5	st.	
1070637	20-20-R $\frac{3}{4}$ "MT	960	5	st.	

Uponor S-Press PLUS muurplaat twin 90° lang

 1070648	16-Rp $\frac{1}{2}$ "FT-16	40	10	st.	
1070649	20-Rp $\frac{1}{2}$ "FT-20	40	10	st.	

Uponor S-Press PLUS aansluitadapter 90°

 1070657	16-Rp $\frac{1}{2}$ "FT	10	1	st.	
--	-------------------------	----	---	-----	--

Uponor S-Press PLUS SK-T-stuk Geberit

 1070659	16-G $\frac{1}{2}$ "FT-16	10	1	st.	
--	---------------------------	----	---	-----	--

Uponor S-Press PLUS SK-knie Geberit

 1070658	16- $\frac{1}{2}$ "FT	80	20	st.	
--	-----------------------	----	----	-----	--

Uponor Smart Aqua SK-schroefkoppeling Geberit

 1058097	16- $\frac{1}{2}$ "FT	25	1	st.	
--	-----------------------	----	---	-----	--

Uponor S-Press PLUS eindkap

 1070621	16	160	40	st.	
1070622	20	7680	20	st.	
1070623	25	3840	10	st.	
1070624	32	1920	5	st.	

art.nr.	omschrijving	LE	VPE	eenheid	prijs/eenheid
---------	--------------	----	-----	---------	---------------

Uponor MLC afperskoppeling

 1013754	14	7680	20	st.	
1013756	16	7680	20	st.	
1013760	20	3840	20	st.	
1013762	25	3840	10	st.	
1013764	32	3840	10	st.	
1013765	40	960	5	st.	

Uponor MLC o-ring voor afperskoppeling

 1013798	14	10000	10	st.	
1013799	16	1000	10	st.	
1013801	20	1000	10	st.	
1013802	25	500	10	st.	
1013803	32	500	10	st.	
1013804	40	10000	10	st.	

Uponor S-Press PLUS montage-unit geluidsisolatieset USP

 1070666	16-Rp $\frac{1}{2}$ "FT c/c150mm	150	5	st.	
--	----------------------------------	-----	---	-----	--

Uponor S-Press PLUS montage-unit

 1070661	16-Rp $\frac{1}{2}$ "FT c/c80mm	5	1	st.	
1070662	16-Rp $\frac{1}{2}$ "FT c/c150mm	380	5	st.	

Uponor S-Press PLUS montage-unit Gemini

 1070663	16-Rp $\frac{1}{2}$ "FT c/c120mm	720	5	st.	
1070664	16-Rp $\frac{1}{2}$ "FT c/c150mm	720	5	st.	

Uponor S-Press PLUS knie overgangsstuk

 1070650	16-15CU l=150mm	2880	20	st.	
1070651	16-12CU l=150mm	2880	20	st.	

Uponor S-Press PLUS wanddoorvoer recht

 1070652	16-G $\frac{1}{2}$ "FT	5	1	st.	
--	------------------------	---	---	-----	--

Uponor S-Press PLUS wanddoorvoer 90° LWC

 1070653	16-Rp $\frac{1}{2}$ "FT l=25	5	1	st.	
1070654	16-Rp $\frac{1}{2}$ "FT l=35	5	1	st.	

Uponor S-Press PLUS U-wanddoorvoer 90° LWC

 1070655	16-Rp $\frac{1}{2}$ "FT-16 l=25	5	1	st.	
1070656	16-Rp $\frac{1}{2}$ "FT-16 l=35	5	1	st.	

Uponor S-Press PLUS

art.nr.	omschrijving	LE	VPE	eenheid
---------	--------------	----	-----	---------

Uponor S-Press PLUS montageplaat

 1121197	80/150mm	5	1	st.
--	----------	---	---	-----

Uponor S-Press PLUS montagebeugel

 1121196	100mm	5	1	st.
1121195	80/150mm	5	1	st.

Uponor Smart Aqua montagebeugel Gemini

 1059824	120mm	5	1	st.
1059825	150mm	5	1	st.

Uponor Smart Aqua enkele montagebeugel

 1057843		5	1	st.
--	--	---	---	-----

Uponor Smart Aqua montagerail

 1057844	2m	10	1	st.
---	----	----	---	-----

Uponor Smart Aqua buigtang voor montageplaat

 1015424	2m	100	1	st.
--	----	-----	---	-----

Uponor Smart Aqua lockpin schroeven (10 st.)

 1057847		-	1	set
--	--	---	---	-----

Speciepluggen Nathan 1/2 buitendraad

 50003600	rood	-	200	st.
50003500	blauw	-	200	st.

LET OP: afname per verpakkingseenheid van 200 st. en/of een veelvoud daarvan.

art.nr.	omschrijving	LE	VPE	eenheid
---------	--------------	----	-----	---------

Uponor S-Press overgangskoppeling SST-CU V

 1090678	16-15CU-SST	10	1	st.
1090679	20-22CU-SST	5	1	st.
1090680	25-22CU-SST	5	1	st.
1090681	32-28CU-SST	5	1	st.

Uponor S-Press overgangskoppeling SST-CU M

 1090682	16-15CU-SST	10	1	st.
1090683	20-22CU-SST	5	1	st.
1090684	25-22CU-SST	5	1	st.
1090685	32-28CU-SST	5	1	st.

Uponor S-Press PLUS overgang koper/RVS

 1070705	16-10CU	80	20	st.
1070706	16-12CU	80	20	st.
1070615	16-15CU	160	20	st.
1070707	20-15CU	3840	10	st.
1070616	20-18CU	40	10	st.
1070617	20-22CU	60	15	st.
1070618	25-22CU	20	5	st.
1070619	25-28CU	1920	5	st.
1070620	32-28CU	20	5	st.

Uponor S-Press koppeling verlopend

 1015172	18-16	80	20	st.
1015185	20-18	80	10	st.

Uponor S-Press overgangskoppeling SST

 OUT 1089056	16-15SST	10	1	st.
OUT 1089057	20-22SST	10	1	st.
OUT 1089058	25-22SST	5	1	st.
OUT 1089059	32-28SST	5	1	st.

OUT Artikel is uitlopend.
Levering zolang de voorraad strekt.





Uponor S-Press PLUS verwarming

art.nr.	omschrijving	LE	VPE	eenheid	prijs/eenheid
---------	--------------	----	-----	---------	---------------

Uponor S-Press PLUS Radi kruisfitting

	1070685 16-16-16	192	1	st.	
	1070686 20-16-16	192	1	st.	
	1070687 20-16-20	192	1	st.	
	1070688 20-20-20	192	1	st.	

Uponor S-Press PLUS Radi kruisfitting geïsoleerd

	1070689 16-16-16	192	1	st.	
	1070690 20-16-16	192	1	st.	
	1070691 20-16-20	192	1	st.	
	1070692 20-20-20	192	1	st.	



Uponor Smart Radi radiator aansluitblok

	1013134 16 h=215mm	240	10	st.	
	1007077 16 h=240mm	240	10	st.	

Uponor S-Press PLUS knie overgangsstuk verchromd

	1070678 16-15CU l=350mm	1680	20	st.	
	1070679 16-15CU l=1000mm	400	20	st.	
	1070680 25-22CU l=250mm	640	20	st.	

Uponor S-Press PLUS T-overgangsstuk verchromd

	1070681 16-15CU-16 l=350mm	600	20	st.	
	1070682 20-15CU-20 l=350mm	600	20	st.	

art.nr.	omschrijving	LE	VPE	eenheid	
---------	--------------	----	-----	---------	--

Uponor S-Press PLUS plintaansluiting

	1070693 16-G $\frac{1}{2}$ "MT-16	192	1	st.	
	1070694 16-G $\frac{1}{2}$ "MT-20	192	1	st.	
	1070695 16-G $\frac{1}{2}$ "MT-0	192	1	st.	
	1070696 20-G $\frac{1}{2}$ "MT-16	192	1	st.	
	1094219 0-G $\frac{1}{2}$ "MT-16	192	1	st.	
	1070697 20-G $\frac{1}{2}$ "MT-20	192	1	st.	

Uponor Smart Base SL-knie SL

	1014060 15x1	25	1	set	
---	---------------------	----	---	-----	--

Uponor S-Press PLUS montageplaatset radi

	1070683 16-Rp $\frac{1}{2}$ "FT c/c35mm	720	5	st.	
	1070684 16-Rp $\frac{1}{2}$ "FT c/c50mm	720	5	st.	

Uponor S-Press PLUS verwarming

art.nr.	omschrijving	LE	VPE	eenheid
---------	--------------	----	-----	---------

Uponor Smart Radi schroefaansluitpijp



1015425	G½"MT-15CU l=350mm	640	20	st.
----------------	--------------------	-----	----	-----

Uponor Smart Radi klemkoppeling elastisch



1013830	15CU-¾" Euro	80	10	st.
----------------	--------------	----	----	-----

Uponor Smart Radi radiatoraansluitnippel



1013906	G¾"MT-G½"MT	80	10	st.
----------------	-------------	----	----	-----

Uponor Smart Radi schroefkoppeling Danfoss



1013970	16-G½"MT	20	1	st.
----------------	----------	----	---	-----

Uponor Smart Radi schroefkoppeling Heimeier



1013978	16-G½"MT	20	1	st.
----------------	----------	----	---	-----

Uponor Smart Radi schroefkoppeling Oventrop



1014016	16-G½"MT	20	1	st.
----------------	----------	----	---	-----

Uponor Smart Radi radiatoraansluitset 16



1011364		100	10	st.
----------------	--	-----	----	-----

Uponor Smart Radi rozet, wit



1011370	16 white	20000	50	st.
----------------	----------	-------	----	-----

Uponor Smart Radi dubbelrozet, wit



1011373	14-20 white double	500	50	st.
----------------	--------------------	-----	----	-----

art.nr.	omschrijving	LE	VPE	eenheid
---------	--------------	----	-----	---------

Uponor S-Press inregelafsluiter Aquastrom T plus



1013243	G¾"MT	300	1	st.
----------------	-------	-----	---	-----

Uponor RTM

art.nr.	omschrijving	LE	VPE	een- heid	prijs/ eenheid
---------	--------------	----	-----	--------------	-------------------

Uponor RTM knie 90° PPSU

 1048547	16-16	40	1	st.	
1048548	20-20	25	1	st.	
1048549	25-25	15	1	st.	

Uponor RTM koppeling PPSU

 1048542	16-16	40	1	st.	
1048543	20-20	30	1	st.	
1048544	25-25	20	1	st.	

Uponor RTM koppeling verlopend PPSU

 1048545	20-16	35	1	st.	
1048546	25-20	25	1	st.	

Uponor RTM T-stuk PPSU

 1048550	16-16-16	24	1	st.	
1048551	20-20-20	20	1	st.	
1048552	25-25-25	10	1	st.	

Uponor RTM T-stuk verlopend PPSU

 1048553	20-16-20	20	1	st.	
1048554	20-16-16	20	1	st.	
1048555	20-20-16	20	1	st.	
1048556	25-20-25	14	1	st.	
1048557	25-20-20	14	1	st.	

Uponor RTM puntstuk

 1048566	16-R $\frac{1}{2}$ "MT	48	1	st.	
1048567	20-R $\frac{1}{2}$ "MT	36	1	st.	
1048568	20-R $\frac{3}{4}$ "MT	25	1	st.	
1048569	25-R $\frac{3}{4}$ "MT	20	1	st.	
1048570	25-R1"MT	20	1	st.	

Uponor RTM koppeling v. klemaansluiting BENELUX

 1062842	16-15mm	10	1	st.	
1062843	20-22mm	10	1	st.	
1062844	25-22mm	5	1	st.	

art.nr.	omschrijving	LE	VPE	een- heid	prijs/ eenheid
---------	--------------	----	-----	--------------	-------------------

Uponor RTM schroefbus

 1048581	16-Rp $\frac{1}{2}$ "FT	48	1	st.	
1048582	20-Rp $\frac{1}{2}$ "FT	36	1	st.	
1048583	20-Rp $\frac{3}{4}$ "FT	25	1	st.	
1048584	25-Rp $\frac{3}{4}$ "FT	25	1	st.	
1048585	25-Rp1"FT	20	1	st.	

Uponor RTM knie 90° buitendraad

 1048599	16-R $\frac{1}{2}$ "MT	30	1	st.	
1048600	20-R $\frac{1}{2}$ "MT	20	1	st.	
1048601	20-R $\frac{3}{4}$ "MT	20	1	st.	
1048602	25-R $\frac{3}{4}$ "MT	15	1	st.	

Uponor RTM knie 90° binnendraad

 1048590	16-Rp $\frac{1}{2}$ "FT	48	1	st.	
1048591	20-Rp $\frac{1}{2}$ "FT	30	1	st.	
1048592	20-Rp $\frac{3}{4}$ "FT	20	1	st.	
1048593	25-Rp $\frac{3}{4}$ "FT	20	1	st.	
1048594	25-Rp1"FT	20	1	st.	

Uponor RTM koppeling verlopend

 1048573	25-16	20	1	st.	
--	-------	----	---	-----	--

Uponor RTM T-stuk verlopend

 1059011	16-20-16	20	1	st.	
--	----------	----	---	-----	--

Uponor RTM T-stuk binnendraad

 1048587	16-Rp $\frac{1}{2}$ "FT-16	30	1	st.	
1048588	20-Rp $\frac{1}{2}$ "FT-20	20	1	st.	
1048589	20-Rp $\frac{3}{4}$ "FT-20	20	1	st.	

Uponor RTM schroefverbinding bi.dr.

 1057375	16- $\frac{1}{2}$ "SN	24	1	st.	
1057376	20- $\frac{3}{4}$ "SN	24	1	st.	

Uponor RTM

art.nr.	omschrijving	LE	VPE	eenheid
---------	--------------	----	-----	---------

Uponor RTM adapter

 1048604	16-G $\frac{3}{4}$ "Euro	25	1	st.
1048605	20-G $\frac{3}{4}$ "Euro	25	1	st.

Uponor RTM koppeling overgang koper/RVS

 1048603	16-15CU	40	1	st.
1057377	25-22CU	20	1	st.

Uponor RTM eindstuk

 1059013	16	48	1	st.
--	----	----	---	-----

Uponor Smart Aqua U-muurplaat RTM

 1061621	16-Rp $\frac{1}{2}$ "FT-16	20	5	st.
---	----------------------------	----	---	-----

Uponor Smart Aqua muurplaat RTM

 1048596	16-Rp $\frac{1}{2}$ "FT	20	1	st.
1048597	20-Rp $\frac{1}{2}$ "FT	20	1	st.
1048598	20-Rp $\frac{3}{4}$ "FT	20	1	st.

Uponor Smart Aqua SK-knie 90° RTM Geberit

 1057380	16-G $\frac{1}{2}$ "FT	35	1	st.
--	------------------------	----	---	-----

art.nr.	omschrijving	LE	VPE	eenheid
---------	--------------	----	-----	---------

Uponor S-Press PLUS montageplaat

 1121197	80/150mm	5	1	st.
--	----------	---	---	-----

Uponor S-Press PLUS montagebeugel

 1121196	100mm	5	1	st.
1121195	80/150mm	5	1	st.

Uponor Smart Aqua montagebeugel Gemini

 1059824	120mm	5	1	st.
1059825	150mm	5	1	st.

Uponor Smart Radi aansluitknie RTM

 1057379	16-15CU l=200mm	15	1	st.
---	-----------------	----	---	-----

Uponor Uni-X

art.nr.	omschrijving	LE	VPE	eenheid	prijs/eenheid
Uponor Uni-X schroefkoppeling MLC					
 1058089	14-3/4"FT Euro	25	1	st.	
1058090	16-3/4"FT Euro	25	1	st.	
1058092	20-3/4"FT Euro	25	1	st.	
1058093	25-3/4"FT Euro	25	1	st.	

Uponor Uni-X schroefkoppeling MLC					
 1058091	18-3/4"FT Euro	25	1	st.	

Uponor Uni-X renovatie overgang MLC					
 1048745	16x2,0-16x2,0	10	1	set	
1048746	16x2,0-16x2,25	10	1	set	
1048747	20x2,25-20x2,25	10	1	set	
1048748	20x2,25-20x2,5	10	1	set	

Uponor Uni-X schroefkoppeling MLC					
 1058094	16-M22	25	1	st.	

Uponor Uni-X schroefkoppeling MLC					
 1058095	16-M24	25	1	st.	

Uponor Uni-X schroefkoppeling MLC Begemac					
 1058096	16-M24	25	1	st.	

art.nr.	omschrijving	LE	VPE	eenheid	prijs/eenheid
Uponor Uni-X overgangstuk					
 1014143	3/4"MT-3/4"FT Euro	80	10	st.	

Uponor Uni-X schroefkoppeling MLC NL					
 1048100	14-15mm	25	1	st.	
1048101	16-15mm	25	1	st.	
1089724	20-15mm	25	1	st.	
1048103	20-22mm	25	1	st.	
1048104	25-22mm	25	1	st.	

Uponor Uni-X S-press adapter Euroconus					
 1087281	20-G3/4"FT Euro	60	15	st.	

Uponor Uni-X dubbele nippel Euroconus					
 1006641	G3/4"MT Euro-G3/4"MT Euro	80	20	st.	

Uponor Uni-X knie 90° buitendraad					
 1014145	3/4"MT-3/4"MT Euro	80	10	st.	

Uponor Uni-X T-stuk buitendraad					
 1014147	3/4"MT-3/4"MT-3/4"MT	40	10	st.	

Uponor GAS MLC

art.nr.	omschrijving	LE	VPE	eenheid
---------	--------------	----	-----	---------

Uponor GAS SAC leiding geel op rol

 1096433	20x2,25 100m	1300	100	m
1096434	25x2,5 50m	700	50	m
1096435	32x3,0 50m	400	50	m

Uponor GAS SAC leiding geel S

 1096436	20x2,25 5m	4335	85	m
1096437	25x2,5 5m	2550	50	m
1096438	32x3,0 5m	1530	30	m

Uponor GAS SAC leiding geel in mantelbuis

 1096439	20x2,25 75m	750	75	m
1096440	25x2,5 50m	500	50	m
1096441	32x3,0 50m	300	50	m

Uponor GAS mantelbuis

 1001390	28/23 yellow 50m	2000	50	m
1001400	34/29 yellow 50m	1400	50	m
1001401	42/36 yellow 50m	600	50	m

art.nr.	omschrijving	LE	VPE	eenheid
---------	--------------	----	-----	---------

Uponor GAS Press puntstuk

 1030552	20-R½"MT	10	1	st.
1030553	20-R¾"MT	10	1	st.
1030554	25-R¾"MT	10	1	st.
1047241	25-R1"MT	10	1	st.
1030555	32-R1"MT	10	1	st.

Uponor GAS Press schroefbus

 1030556	20-Rp½"FT	10	1	st.
1030557	20-Rp¾"FT	10	1	st.
1030558	25-Rp¾"FT	10	1	st.
1030559	25-Rp1"FT	10	1	st.
1042419	32-Rp1"FT	10	1	st.
1030560	32-Rp1 ¼"FT	10	1	st.

Uponor GAS Press knie 90°

 1030561	20-20	10	1	st.
1030562	25-25	10	1	st.
1030563	32-32	10	1	st.

LET OP!

Het Uponor Q&E GAS leidingsysteem voor gasinstallaties mag niet in België en Luxemburg toegepast worden.

Uponor GAS MLC

art.nr.	omschrijving	LE	VPE	eenheid	prijs/eenheid
Uponor GAS Press T-stuk binnendraad					
 1030564	20-Rp½"FT-20	10	1	st.	
1030565	25-Rp½"FT-25	10	1	st.	
1042538	20-Rp¾"FT-20	10	1	st.	
1042539	25-Rp¾"FT-25	10	1	st.	
1030566	32-Rp¾"FT-32	10	1	st.	

Uponor GAS Press T-stuk

 1083617	20-20-20	10	1	st.	
1030567	25-25-25	10	1	st.	
1030568	32-32-32	10	1	st.	

Uponor GAS Press T-stuk verlopend

 1030569	25-20-20	10	1	st.	
1030570	25-20-25	10	1	st.	
1030571	32-25-32	10	1	st.	
1030572	32-25-25	10	1	st.	

Uponor GAS Press koppeling

 1030573	20-20	10	1	st.	
1030574	25-25	10	1	st.	
1030575	32-32	10	1	st.	

Uponor GAS Press koppeling verlopend

 1030576	25-20	10	1	st.	
1042540	32-25	10	1	st.	

Uponor GAS Press muurplaat

 1030577	20-Rp½"FT	10	1	st.	
1083615	25-Rp¾"FT	5	1	st.	

art.nr.	omschrijving	LE	VPE	eenheid
Uponor GAS veiligheidsverdeler inclusief gasstromingsbeveiliging				
 1086826	Rp¾"FT 2XRp¾"FT c/c50mm	12	1	st.
1086827	Rp¾"FT 3XRp¾"FT c/c50mm	6	1	st.

Uponor GAS gasstromingsbeveiliging type K

 1086164	R½"MT-RP½"FT GS15HH2,5AIZ65	10	1	st.
1086162	R¾"MT-RP¾"FT GS20HH2,5AIZ165	10	1	st.
1083624	R¾"MT-Rp¾"FT GS20HH4AIZ165	10	1	st.
1086163	R1"MT-RP1"FT GS25HH2,5AIZ165	10	1	st.
1086161	R1"MT-RP1"FT GS25HH4AIZ165	10	1	st.
1083628	R1"MT-Rp1"FT GS25HH6AIZ165	10	1	st.

LET OP!

Het Uponor Q&E GAS leidingsysteem voor gasinstallaties mag niet in België en Luxemburg toegepast worden.

Uponor RS

Verdeel- en stijgleidingen 63-110 mm



RS 2 Adapter	RS 2 Basiscomponent	RS 3 Basiscomponent	RS 3 Adapter
40, 50, 63, 75 1½", 2", 2½" ½", 1", 2", 2½" 16, 20, 25, 32 DN 65 (PN 6/PN 16) 130 mm 5 mm			90, 110 3" ½", 3" DN 80 (PN 6/PN 16) DN 100 (PN 6/PN 16) 210 mm 5 mm

Uponor RS

art.nr.	omschrijving	LE	VPE	eenheid	prijs/eenheid
---------	--------------	----	-----	---------	---------------

Uponor RS koppeling

 1029144	RS2-RS2	480	1	st.	
1029145	RS3-RS3	480	1	st.	

Uponor RS knie 90°

 1029138	RS2-RS2	336	1	st.	
1029139	RS3-RS3	240	1	st.	

Uponor RS knie 45°

 1029140	RS2-RS2	336	1	st.	
1029141	RS3-RS3	175	1	st.	

Uponor RS T-stuk

 1029142	RS2-RS2-RS2	336	1	st.	
1029143	RS3-RS3-RS3	175	1	st.	

Uponor RS koppeling verlopend

 1029146	RS3-RS2	480	1	st.	
--	---------	-----	---	-----	--

Uponor RS verlengstuk

 1046750	RS2-RS2 l=5mm	480	1	st.	
1046751	RS3-RS3 l=5mm	240	1	st.	

Uponor RS verlengstuk

 1046477	RS2-RS2 l=130mm	240	1	st.	
1046478	RS3-RS3 l=210mm	96	1	st.	

art.nr.	omschrijving	LE	VPE	eenheid	
---------	--------------	----	-----	---------	--

Uponor RS adapter S-Press

 1059397	16-RS2	480	1	st.	
--	--------	-----	---	-----	--

Uponor RS adapter S-Press PLUS

 1095818	20-RS2	378	1	st.	
1095819	25-RS2	378	1	st.	
1095820	32-RS2	378	1	st.	

Uponor RS adapter S-Press

 1046940	40-RS2	480	1	st.	
1046941	50-RS2	480	1	st.	
1029125	63-RS2	400	1	st.	
1029126	75-RS2	400	1	st.	
1029127	90-RS3	240	1	st.	
1029128	110-RS3	240	1	st.	

Uponor RS adapter puntstuk

 1059402	R1 ½"MT-RS2	480	1	st.	
1029131	R2"MT-RS2	480	1	st.	
1029132	R2 ½"MT-RS2	480	1	st.	
1029133	R3"MT-RS3	240	1	st.	

Uponor RS adapter schroefbus

 1059403	Rp½"FT-RS2	480	1	st.	
1029134	Rp1"FT-RS2	480	1	st.	
1029135	Rp2"FT-RS2	480	1	st.	
1029136	Rp2 ½"FT-RS2	480	1	st.	
1059404	Rp½"FT-RS3	336	1	st.	
1029137	Rp3"FT-RS3	240	1	st.	

Uponor RS flens

 1059398	RS2-DN65 (PN6)	144	1	st.	
1059399	RS2-DN65 (PN16)	90	1	st.	
1059400	RS3-DN80 (PN6)	90	1	st.	
1029129	RS3-DN80 (PN16)	90	1	st.	
1059401	RS3-DN100 (PN6)	90	1	st.	
1029130	RS3-DN100 (PN16)	90	1	st.	

Uponor RS vergrendelingselement

 1042921	RS2 zwart	5000	10	st.	
1042922	RS3 grijs	-	10	st.	

Uponor PE-Xa installatiesystemen

art.nr.	omschrijving	LE	VPE	eenheid
---------	--------------	----	-----	---------

Uponor Aqua Pipe

Uponor Aqua Pipe naturel PN10

	1022682	16x2,2	100 m	1100	100	m
NEW	1134939	16x2,2	500 m	–	2000	m
	1001201	20x2,8	50 m	550	50	m
NEW	1134940	20x2,8	500 m	–	1500	m
	1001202	25x3,5	50 m	400	50	m
	1001203	32x4,4	50 m	350	50	m

Uponor Aqua Pipe naturel PN10 S

	1008407	20x2,8 6m		240	30	m
	1008424	25x3,5 6m		12	6	m
	1001206	32x4,4 6m		1080	12	m

Uponor Aqua Pipe naturel in mantelbuis black

	1008993	16x2,2 25/20		550	50	m
	1008994	20x2,8 28/23		400	50	m
	1008995	25x3,5 34/28		300	50	m

Uponor Radi Pipe

Uponor Radi Pipe naturel PN6

	1047610	16x2,0		960	120	m
	1022518	20x2,0		840	120	m
	1022689	25x2,3		450	50	m
	1001220	32x2,9		550	50	m

Uponor Radi Pipe naturel PN6 S

	1001221	25x2,3 6m		12	6	m
	1001222	32x2,9 6m		12	6	m

Uponor Radi Pipe naturel in mantelbuis PN6 red

	1008388	16x2,0 25/20		550	50	m
	1042149	20x2,0 28/23		400	50	m

Uponor Radi Pipe naturel in mantelbuis PN6 black

	1072092	25x2,3 34/28		300	50	m
---	---------	--------------	--	-----	----	---

Uponor Combi Pipe

Uponor Combi Pipe naturel PN10

	1060081	12x1,7		840	60	m
---	---------	--------	--	-----	----	---

art.nr.	omschrijving	LE	VPE	eenheid
---------	--------------	----	-----	---------

Uponor Teck

Uponor Teck mantelbuis rood red

	1012858	25/20		2500	50	m
	1012862	28/23		2000	50	m
	1012866	35/29		1400	50	m

Uponor Teck mantelbuis blauw blue

	1012859	25/20		2500	50	m
	1012863	28/23		2000	50	m
	1012867	35/29		1400	50	m

Uponor Teck mantelbuis zwart black

	1012860	25/20		2500	50	m
	1012864	28/23		2000	50	m
	1012869	35/29		1400	50	m
	1012872	43/36		600	25	m

Uponor Q&E zekeringsring white

	1057453	16		900	20	st.
	1057454	20		520	20	st.
	1057455	25		300	20	st.
	1057456	32		150	10	st.

Uponor Q&E zekeringsring red

	1058010	16		900	20	st.
	1058011	20		520	20	st.
	1058012	25		300	20	st.

Uponor Q&E zekeringsring blue

	1058013	16		900	20	st.
	1058014	20		520	20	st.
	1058015	25		300	20	st.

Uponor Q&E ring met stop edge

	1058454	12 rood		1200	20	st.
	1058453	12 blauw		1200	20	st.

Uponor PE-Xa installatiesystemen

art.nr.	omschrijving	LE	VPE	eenheid	prijs/eenheid
---------	--------------	----	-----	---------	---------------

Uponor Q&E verdeler PPSU

 1008718	25, 3X16 c/c45+35	15	1	st.	
1008719	25 4X16 c/c45+2X35	15	1	st.	

Uponor Q&E knie 90° PPSU

 1008679	16-16	100	5	st.	
1008680	20-20	40	5	st.	
1008681	25-25	25	5	st.	
1001245	32-32	10	1	st.	

Uponor Q&E koppeling PPSU

 1008669	16-16	100	5	st.	
1008932	20-20	80	5	st.	
1008671	25-25	50	5	st.	
1001235	32-32	15	1	st.	

Uponor Q&E koppeling verlopend PPSU

 1008674	20-16	100	5	st.	
1008675	25-16	40	5	st.	
1008676	25-20	40	5	st.	
1001240	32-25	20	1	st.	

Uponor Q&E T-stuk PPSU

 1008684	16-16-16	60	5	st.	
1008685	20-20-20	30	5	st.	
1008686	25-25-25	20	5	st.	
1001250	32-32-32	10	1	st.	

Uponor Q&E T-stuk verlopend PPSU

 1008700	20-16-16	40	5	st.	
1008689	20-16-20	40	5	st.	
1008697	20-20-16	40	5	st.	
1008711	20-25-20	25	5	st.	
1008702	25-16-16	25	5	st.	
1008699	25-16-20	25	5	st.	
1008690	25-16-25	25	5	st.	
1008701	25-20-16	25	5	st.	
1008703	25-20-20	25	5	st.	
1008691	25-20-25	20	5	st.	
1001420	25-25-20	20	5	st.	
1008712	25-32-25	15	1	st.	
1001422	32-20-25	15	1	st.	
1001424	32-20-32	15	1	st.	
1008704	32-25-20	15	1	st.	
1001426	32-25-25	15	1	st.	
1001428	32-25-32	15	1	st.	

art.nr.	omschrijving	LE	VPE	eenheid	
---------	--------------	----	-----	---------	--

Uponor Q&E puntstuk PL

 1023003	16-R½"MT	100	5	st.	
1023004	16-R¾"MT	80	5	st.	
1023005	20-R½"MT	100	5	st.	
1023006	20-R¾"MT	70	5	st.	
1023007	25-R¾"MT	70	5	st.	
1023008	25-R1"MT	40	5	st.	
1047191	32-R1"MT	10	1	st.	

Uponor Q&E puntstuk PL

 1058462	12-G½"MT	100	10	st.	
--	----------	-----	----	-----	--

Uponor Q&E schroefbus PL

 1058464	12-Rp½"FT	100	10	st.	
1023009	16-Rp½"FT	60	5	st.	
1023010	20-Rp½"FT	60	5	st.	
1023011	20-Rp¾"FT	40	5	st.	
1023012	25-Rp¾"FT	40	5	st.	
1023013	25-Rp1"FT	35	5	st.	

Uponor Q&E schroefbus PL

 1047866	32-G1"FT	20	1	st.	
--	----------	----	---	-----	--

Uponor Q&E knie 90° PL

 1058470	12-12	200	10	st.	
1047197	16-16	80	5	st.	
1047198	20-20	40	5	st.	
1047199	25-25	25	5	st.	

Uponor Q&E knie buitendraad PL

 1058471	12-G¾"MT	100	10	st.	
1058472	12-G½"MT	120	10	st.	
1023019	16-G½"MT	80	5	st.	
1023020	20-G½"MT	50	5	st.	
1023021	20-G¾"MT	40	5	st.	
1023022	25-G¾"MT	40	5	st.	

Uponor Q&E knie binnendraad PL

 1023023	16-G½"FT	70	5	st.	
1023024	20-G½"FT	50	5	st.	
1023025	20-G¾"FT	30	5	st.	
1023026	25-G¾"FT	35	5	st.	

Uponor PE-Xa installatiesystemen

art.nr.	omschrijving	LE	VPE	eenheid
---------	--------------	----	-----	---------

Uponor Q&E koppeling PL

 1058467	12-12	250	10	st.
1047193	16-16	100	10	st.
1047194	20-20	80	5	st.
1047195	25-25	50	5	st.

Uponor Q&E koppeling verlopend PL

 1058468	16-12	200	10	st.
1047875	32-25	2880	30	st.

Uponor Q&E T-stuk PL

 1058475	12-12-12	150	10	st.
--	----------	-----	----	-----

Uponor Q&E T-stuk verlopend PL

 1058477	16-12-12	120	10	st.
1058478	16-12-16	100	10	st.
1058479	16-16-12	100	10	st.

Uponor Q&E T-stuk binnendraad PL

 1047885	16-Rp $\frac{1}{2}$ "FT-16	50	5	st.
1047886	20-Rp $\frac{1}{2}$ "FT-20	30	5	st.
1047887	25-Rp $\frac{1}{2}$ "FT-25	25	5	st.
1047888	25-Rp $\frac{3}{4}$ "FT-25	20	5	st.

Uponor Q&E schroefkoppeling vlakd. PL

 1058466	12-G $\frac{1}{2}$ "SN	100	10	st.
1023014	16-G $\frac{1}{2}$ "SN	100	5	st.
1023015	20-G $\frac{1}{2}$ "SN	60	5	st.
1023016	20-G $\frac{3}{4}$ "SN	50	5	st.
1023017	25-G $\frac{3}{4}$ "SN	45	5	st.
1023018	25-G1"SN	40	5	st.

art.nr.	omschrijving	LE	VPE	eenheid
---------	--------------	----	-----	---------

Uponor Q&E schroefverbindingknie bi. PL

 1058473	12-G $\frac{3}{8}$ "SN	100	10	st.
--	------------------------	-----	----	-----

Uponor Q&E overgang DR S-Press

 1062845	16-Q&E16	20	1	st.
1062846	20-Q&E20	10	1	st.
1062861	25-Q&E25	10	1	st.

Uponor Q&E overgangskoppeling soldeer PL

 1085248	12-15CU	100	5	st.
1047938	16-12CU	100	5	st.
1023040	16-15CU	100	5	st.
1023041	20-15CU	100	5	st.
1047940	20-18CU	80	5	st.
1047941	20-22CU	80	5	st.
1023042	25-22CU	40	5	st.

Uponor Smart Aqua U-muurplaat Q&E

 1059820	16-Rp $\frac{1}{2}$ "FT-16	5	1	st.
1059821	20-Rp $\frac{1}{2}$ "FT-20	5	1	st.

Uponor Smart Aqua muurplaat Q&E PL

 1095355	12-Rp $\frac{1}{2}$ "FT	40	5	st.
1059822	16-Rp $\frac{1}{2}$ "FT	40	5	st.
1059823	20-Rp $\frac{1}{2}$ "FT	40	5	st.

Uponor Q&E verdeler bi./bu. PL

 1023027	$\frac{3}{4}$ "MT/FT 2X16 c/ c35mm	20	1	st.
1023028	$\frac{3}{4}$ "MT/FT 3X16 c/ c35mm	15	1	st.
1023029	$\frac{3}{4}$ "MT/FT 4X16 c/ c35mm	10	1	st.

Uponor PE-Xa installatiesystemen

art.nr.	omschrijving	LE	VPE	eenheid	prijs/eenheid
---------	--------------	----	-----	---------	---------------

Uponor S-Press PLUS montageplaat

 1121197	80/150mm	5	1	st.	
--	----------	---	---	-----	--

Uponor S-Press PLUS montagebeugel

 1121196	100mm	5	1	st.	
1121195	80/150mm	5	1	st.	

Uponor Smart Aqua montagebeugel Gemini

 1059824	120mm	5	1	st.	
1059825	150mm	5	1	st.	

Uponor Smart Aqua enkele montagebeugel

 1057843		5	1	st.	
--	--	---	---	-----	--

Uponor Smart Aqua montagerail

 1057844	2m	10	1	st.	
---	----	----	---	-----	--

Uponor Smart Aqua buigtang voor montageplaat

 1015424	2m	100	1	st.	
--	----	-----	---	-----	--

Uponor Teck plughaken enkel

	NEW 1135511	32	1600	200	st.	0,49
	NEW 1135512	32	1600	200	st.	0,49

Uponor Teck plughaken dubbel

	NEW 1135513	32	1200	200	st.	0,63
	NEW 1135514	32	800	200	st.	0,65

Uponor Multi leiding geleidingsbocht

	NEW 1135491	14-18	240	30	st.	3,18
	NEW 1135492	20-22	140	35	st.	4,02

Uponor Multi leiding geleidebocht kunststof

 1001230	28	900	50	st.	
--	----	-----	----	-----	--

Uponor Multi leiding geleidebocht staal

 1001231	34	1400	2	st.	
--	----	------	---	-----	--

art.nr.	omschrijving	LE	VPE	eenheid	
---------	--------------	----	-----	---------	--

Uponor Smart Aqua muurplaat Q&E PL

 1023034	16-Rp $\frac{1}{2}$ "FT l=43mm	40	5	st.	
1023035	20-Rp $\frac{1}{2}$ "FT l=43mm	40	5	st.	

Uponor Smart Radi radiatoraansluitknie Q&E

 1023045	16-15CU l=300mm	40	2	st.	
1023047	16-15CU l=1100mm	20	2	st.	
1023046	20-15CU l=300mm	30	2	st.	

Uponor Smart Radi radiatoraansl.-T-stuk Q&E

 1023049	16-15CU-16 l=300mm	30	2	st.	
1023050	20-15CU-20 l=300mm	30	2	st.	

Uponor Smart Radi inbouwdoos voor radiatoraansluitknie

 1001366	c/c40-45-50mm	10	1	set	
---	---------------	----	---	-----	--

Uponor Flex-X schroefkoppeling Euroconus PEX

 1057441	16x1,8/2,0- $\frac{3}{4}$ "FT Euro	100	10	st.	
1057442	20x1,9/2,0- $\frac{3}{4}$ "FT Euro	100	10	st.	

Uponor Smart Radi klemkoppeling elastisch

 1013830	15CU- $\frac{3}{4}$ " Euro	80	10	st.	
--	----------------------------	----	----	-----	--

Uponor Smart Radi radiatoraansluitnippel

 1013906	G $\frac{3}{4}$ "MT-G $\frac{1}{2}$ "MT	80	10	st.	
--	---	----	----	-----	--

Uponor Smart Radi dubbelrozet, wit

 1011373	14-20 white double	500	50	st.	
--	--------------------	-----	----	-----	--

Uponor PE-Xa Aqua PLUS verdeler PPM

art.nr.	omschrijving	LE	VPE	eenheid
---------	--------------	----	-----	---------



Uponor Aqua PLUS verdeler PPM

 1087121	3X c/c50mm	8	1	st. M7
1087122	2X c/c50mm	10	1	st. M7
1087123	1X c/c50mm	20	1	st. M7

Uponor Aqua PLUS verdeler 1+1 PPM

 1087124	1+1X c/c50mm	15	1	st. M7
--	--------------	----	---	--------

Uponor Aqua PLUS afsluitventiel PPM blauw

 1096407		50	1	st. M7
 1096408		50	1	st. M7

Uponor Aqua PLUS Q&E aansluiting PPSU PPM

 OUT 1087111	12	30	1	st. M7
OUT 1087112	16	30	1	st. M7
OUT 1087113	20	30	1	st. M7

Uponor S-Press aansluiting Aqua PLUS PPM

 1087117	20	30	1	st. M7
--	----	----	---	--------

Uponor S-Press PLUS aansluiting PPSU

 1119005	16	30	1	st.
--	----	----	---	-----

Uponor Aqua PLUS aansluiting PL/DR PPM FPL

 1087118	G1/2"MT	30	1	st. M7
--	---------	----	---	--------

Uponor Aqua PLUS plug PPSU PPM

 1087110		30	1	st. M7
--	--	----	---	--------

Uponor Aqua PLUS moersleutel PPM

 1092669		1000	1	st. M7
--	--	------	---	--------

Uponor Aqua PLUS MT overgang buitendraad PPM

 1048002	1" G3/4"MT	20	1	st. M7
--	------------	----	---	--------

Uponor Aqua PLUS MT overgang binnendraad SN PPM

 1063785	1"MT-G3/4"SN	20	1	st. M7
--	--------------	----	---	--------

Uponor Aqua PLUS FT overgang binnendraad SN PPM

 1063811	1"FT-3/4"SN	25	1	st. M7
--	-------------	----	---	--------

art.nr.	omschrijving	LE	VPE	eenheid
---------	--------------	----	-----	---------

Uponor Aqua PLUS MT overgangsknie buitendraad PPM

 1048003	1" G3/4"MT	20	1	st. M7
--	------------	----	---	--------

Uponor Aqua PLUS MT overgangsknie binnendraad PPM

 1063782	1"MT-1"FT	20	1	st. M7
--	-----------	----	---	--------

Uponor Aqua PLUS eindkap PPM

 1048004	1"FT	20	1	st. M7
--	------	----	---	--------

Uponor Aqua PLUS ontluchtingseindkap PPM

 1048005	1"FT	20	1	st. M7
--	------	----	---	--------

Uponor Aqua PLUS eindplug verdeler PPM

 1087119	MT	30	1	st. M7
--	----	----	---	--------

Uponor Aqua PLUS verdelerhouder PPM

 1092021		50	1	set M7
---	--	----	---	--------

Uponor Aqua PLUS PPM

 1087375		20	1	set M7
--	--	----	---	--------

Uponor Aqua PLUS isolatie verdeler EPP

 1087016	10x c/c50mm l=600	60	1	set M7
--	-------------------	----	---	--------

Uponor Aqua PLUS kap isolatie verdeler EPP

 1087017	d=91mm	16	1	st. M7
--	--------	----	---	--------

Uponor Q&E GAS

art.nr.	omschrijving	LE	VPE	een- heid	prijs/ eenheid
---------	--------------	----	-----	--------------	-------------------

Uponor GAS evalPEX leiding geel

 1001383	16x2,2 100m	1100	100	m	
1001385	20x2,8 50m	500	50	m	
1001386	25x3,5 50m	450	50	m	

Uponor GAS evalPEX leiding geel in mantelbuis yellow

 1001382	16x2,2 25/20 50m	550	50	m	
1001384	20x2,8 28/23 50m	350	50	m	

Uponor GAS mantelbuis

 1001390	28/23 yellow 50m	2000	50	m	
1001400	34/29 yellow 50m	1400	50	m	
1001401	42/36 yellow 50m	600	50	m	

Uponor Q&E puntstuk PL

 1023003	16-R $\frac{1}{2}$ "MT	100	5	st.	
1023005	20-R $\frac{1}{2}$ "MT	100	5	st.	
1023006	20-R $\frac{3}{4}$ "MT	70	5	st.	
1023007	25-R $\frac{3}{4}$ "MT	70	5	st.	

Uponor Q&E koppeling PL

 1047193	16-16	100	10	st.	
1047194	20-20	80	5	st.	
1047195	25-25	50	5	st.	

Uponor Q&E knie 90° PL

 1047197	16-16	80	5	st.	
1047198	20-20	40	5	st.	
1047199	25-25	25	5	st.	

Uponor Q&E overgangskoppeling soldeer PL

 1023040	16-15CU	100	5	st.	
1023041	20-15CU	100	5	st.	
1023042	25-22CU	40	5	st.	

Uponor Smart Aqua muurplaat Q&E PL

 1059822	16-Rp $\frac{1}{2}$ "FT	40	5	st.	14,24
1059823	20-Rp $\frac{1}{2}$ "FT	40	5	st.	16,35

art.nr.	omschrijving	LE	VPE	een- heid
---------	--------------	----	-----	--------------

Uponor Q&E ring met stop-edge natural

 1044993	32	150	10	st.
--	----	-----	----	-----

Uponor Q&E Ring met stop-edge natural, eval

 1042389	16	900	20	st.
1042837	20	520	20	st.
1042841	25	300	20	st.

Uponor GAS veiligheidsverdeler inclusief gasstromingsbeveiliging

 1086826	Rp $\frac{3}{4}$ "FT 2XRp $\frac{3}{4}$ "FT c/ c50mm	12	1	st.
1086827	Rp $\frac{3}{4}$ "FT 3XRp $\frac{3}{4}$ "FT c/ c50mm	6	1	st.

Uponor GAS gasstromingsbeveiliging type K

 1086164	R $\frac{1}{2}$ "MT-RP $\frac{1}{2}$ "FT GS15HH2,5AIZ65	10	1	st.
1086162	R $\frac{3}{4}$ "MT-RP $\frac{3}{4}$ "FT GS20HH2,5AIZ165	10	1	st.
1083624	R $\frac{3}{4}$ "MT-Rp $\frac{3}{4}$ "FT GS20HH4AIZ165	10	1	st.
1086163	R1"MT-RP1"FT GS25HH2,5AIZ165	10	1	st.
1086161	R1"MT-RP1"FT GS25HH4AIZ165	10	1	st.
1083628	R1"MT-Rp1"FT GS25HH6AIZ165	10	1	st.

LET OP!









Het Uponor Q&E GAS leidingsysteem voor gasinstallaties mag niet in België en Luxemburg toegepast worden.

Uponor systemen om te verwarmen en te koelen

	Soort installatie	Systeemplaatdikte	Minimale opbouwhoogte* mm	Systeemnaam	Beschrijving	Bijbehorende systeemleidingen	Afmeting (mm)	
VLOER	NATBOUW	Noppenplaat-plaatsing, zelfklevend	—	15	Uponor Minitec	Zeer geringe opbouwhoogte, direct op de oude ondergrond (dekvloer, tegels, hout...)	Comfort Pipe	9,9
		Klittenband	DES 25-2, 30-2, 30-3, 35-3 WLS032 25-2, DEO 15	74	Uponor Klett	Microvertanding van systeemplaat en leiding. Snelste installatiemanier, geen beschadiging van de dekvloerfilm	Klett Comfort Pipe PLUS Klett MLCP RED	14, 16 16
		Klittenband op bestaande isolatieplaat	—	74	Uponor Klett Twinboard	Plaatsing met klittenband op bestaande isolatieplaat via montageplaten met holle kamer 3 mm	Klett Comfort Pipe PLUS Klett MLCP RED	14, 16 16
		Klittenband incl. isolatie in minerale wol	30	74	Uponor Klett Silent	Plaatsing met klittenband op platen in minerale wol, alternatieve uitschrijvingen	Klett Comfort Pipe PLUS Klett MLCP RED	14, 16 16
		In noppenfolie	—	30	Uponor Nubos	Vrije keuze van isolatiematerialen	Comfort Pipe PLUS Blue Comfort Pipe PLUS MLCP RED	16 16 14, 16
		In noppenplaat	11 of 30-2	82	Uponor Tecto	Snelle montage van de leidingen, systeemplaten voor scheidingsplafonds van verdiepingen, stevige bevestiging	Comfort Pipe PLUS Blue Comfort Pipe PLUS MLCP RED	16 14, 17 14, 16
		In noppenplaat	11 of 30-2	78	Uponor Nubos	Gemakkelijk te gebruiken, normconforme plaatsingsafstanden	Comfort Pipe PLUS Blue Comfort Pipe PLUS MLCP RED	16 16 14, 16
		Op mattenwaping met clip	—	83	Uponor Classic	Hoogste geluidsisolatie (bestaande isolatie in minerale wol). Scheiding van verwarmingsniveau/dekvloer, grote verwarmingscircuits	Comfort Pipe PLUS Blue Comfort Pipe PLUS Magna Pipe PLUS	16, 20 17 20
		Tacker en U-rails	EPS DEO 20, 26, 30 WLS040 50 DES 20-2, 25-2, 30-2, 30-3, 35-3, 40-3 WLS032 25-2	75	Uponor Tacker	Goedkoopste oplossing. Verschillende soorten thermische/contactgeluidisolatie verkrijgbaar	Comfort Pipe PLUS Blue Comfort Pipe PLUS MLCP RED	16 16, 17 14, 16
DROOG	In voorgevormde EPS-platen en warmtegeleidingslamellen in aluminium	25	50	Uponor Siccus 14	Laag gewicht, onmiddellijk bruikbaar, hoge draagkracht	Comfort Pipe PLUS MLCP RED	14 14	
	Met geprefabriceerde kabelmatten, elektrische vloerverwarming	—	5	Uponor Comfort E Kabelmatten	Kabelmat met opgenaaide aluminiumfolie, zeer geringe opbouwhoogte, plaatsing op nagenoeg alle solide ondergronden, incl. regelmatig, snelle reactie	—		

		Soort installatie	Systeem- plaat- dikte	Mini- male op- bouw- hoogte* mm	Systeemnaam	Beschrijving	Bijbehorende systeemleidingen	Afmeting (mm)
WAND	NAT	Onder pleisterlaag, met spanrail	—	32	Uponor Fix	Efficiënte en torsievaste plaatsing van de leidingen vanaf de grote rol met minimaal snijafval	Comfort Pipe Comfort Pipe PLUS MLCP RED	9,9 14 14
	DROOG	In voorgevormde EPS-platen	25	30	Uponor Siccus Wall	Geen droogtijden en geen functieverwarming vereist	Comfort Pipe PLUS MLCP RED	14 14
		Op CD-profielen 60/27, gipspaneel met geïntegreerde verwarmingsleidingen	—	15	Uponor Renovis	Vezelversterkte gipsplaat 15 mm, montage op gedefinieerde droogbouw-onderconstructies	Comfort Pipe PLUS (geïntegreerd)	9,9
PLAFOND	NAT	Onder pleisterlaag, met spanrail	—	32	Uponor Fix	Efficiënte en torsievaste plaatsing van de leidingen vanaf de grote rol met minimaal snijafval	Comfort Pipe	9,9
	DROOG	Op CD-profielen 60/27, gipspaneel met geïntegreerde verwarmingsleidingen	—	15	Uponor Renovis	Hoog plaatsingsrendement op CD-profielen	Comfort Pipe (geïntegreerd)	9,9
		Gipsplaat incl. EPS-Dämmung	27	27	Uponor Teporis	27 mm EPS Isolatieplaat	Comfort Pipe (geïntegreerd)	9,9
		Standaard onderconstructies	—	15	Uponor Thermatop M	Voeg- en richtingloze plafondoppervlakken	Uni Pipe PLUS	16
ANDERE TOEPASSINGEN	HALLEN	INDUSTRIËLE OPPERVLAKTEVERWARMING						
		Op spanrail			Uponor Magna	Optimaal gebruik van de ruimte zonder storende installatiecomponenten	Comfort Pipe PLUS Blue Magna Pipe PLUS	20 20, 25
	Op mattenwapening							
	TABS	BETONKERNACTIVERING						
		Geprefabriceerde module op mattenwapening (wapening)			Uponor Contec	Om in de betonkern in te brengen	Magna Pipe PLUS	20
		Dicht bij het oppervlak			Uponor Contec ON	Diagonaal vastgezet honingraatrooster met voorbereide leidingen voor inbouw in de betonkern dicht tegen het oppervlak	Comfort Pipe PLUS Magna Pipe PLUS	14 20
	DROOG	SPORTVLOEREN						
		In sporthallen	30		Uponor Siccus Sport	Voor oppervlakelastische sportvloeren in sandwichbouwmethode	Comfort Pipe PLUS MLC wit	14 14
		In sporthallen			Uponor Sport	Voor inbouw tussen onderlagen van oppervlakelastische sportvloeren	Magna Pipe PLUS	25
	OPEN VLAKTEN	OPPERVLAKTEVERWARMING / GRASVELDEN						
	Sneeuw- en ijsvrijhouden van open vlakten			Uponor Meltaway	Montage met spanrail, voor veilige toegangen, bijv. opritten en toegangswegen naar ziekenhuizen, garages, landingsplaatsen voor helikopters of vliegtuigen, enz.	Magna Pipe PLUS	20, 25	

Uponor leidingen voor oppervlakteverwarming/-koeling

Type	Afmeting [mm]	Condensbarrière	Leidingkleur, Markering	Druk [bar]	Temperatuur [°C]	Lengte [m]	Artikelnr.	DIN-Certco Certificaat-nr.	
Comfort Pipe PLUS 	14 x 2,0	PE-Xa + EVOH-isolatielaag	wit, 2 blauwe stroken	6	70	120 240 640 960	1062883 1062884 1088166 1062885	3V372	
	16 x 2,0	PE-Xa + EVOH-isolatielaag	wit, 2 blauwe stroken	6	70	120 240 640	1062044 1062045 1062046	3V372	
	17 x 2,0	PE-Xa + EVOH-isolatielaag	wit, 2 blauwe stroken	6	70	120 240 480 640	1034535 1009226 1086340 1009227	3V372	
	20 x 2,0	PE-Xa + EVOH-isolatielaag	wit, 2 blauwe stroken	6	70	60	1009229	3V372	
Comfort Pipe PLUS BLUE 	16 x 2,0	PE-Xa + EVOH-isolatielaag	wit, 2 blauwe stroken	6	70	60	1126541	3V372 ISCC-Certificaat	
	20 x 2,0	PE-Xa + EVOH-isolatielaag	wit, 2 blauwe stroken	6	70	60	1126542	3V372 ISCC-Certificaat	
Uponor Comfort Pipe PN10 	16 x 2,2	PE-Xa + EVOH-isolatielaag	natuur	10	70	240 640	1119470 1119471		
	20 x 2,8	PE-Xa + EVOH-isolatielaag	natuur	10	70	240 640	1119472 1119533		
Klett Comfort Pipe PLUS 	14 x 2,0	PE-Xa + EVOH-isolatielaag	wit, 2 blauwe stroken, met klittenband	6	70	240 640	1088479 1088480	3V372	
	16 x 2,0	PE-Xa + EVOH-isolatielaag	wit, 2 blauwe stroken, met klittenband	6	70	240 640	1087302 1087303	3V372	
Magna Pipe PLUS 	20 x 2,0	PE-Xa + EVOH-isolatielaag	wit, 2 blauwe stroken	6	70	240 480	1091275 1091276	3V415	
	25 x 2,3	PE-Xa + EVOH-isolatielaag	wit, 2 blauwe stroken	6	70	300 640	1091277 1091278	3V415	
Minitec Comfort Pipe 	9,9 x 1,1	PE-Xa + EVOH-isolatielaag	natuur, 1 blauwe strook	6	70	60 120 480	1063287 1063288 1063381	3V279	
MLC Rohr wit 	14 x 2,0	Composietleiding met AL	witte leiding	10	80	200	1013366		
MLCP RED 	14 x 1,6	Composietleiding met AL	rode leiding	4	60	240 480	1096010 1096011	3V286	
	16 x 2,0	Composietleiding met AL	rode leiding	4	60	240 480	1096012 1096013	3V445	
MLCP RED Klett 	16 x 2,0	Composietleiding met AL	witte leiding, 2 rode stroken, met klittenband	4	60	240 480	1096014 1096015	3V286	

Verbindingstechniek, fittingen en gereedschap

(Klemring-)schroefkoppelingen



Platte sleutel
courant



Quick & Easy-fittingen



Q&E expansie-
gereedschap



bijbehorende
Q&E ringen



Rapex persfittingen



Rapex
persbekken



Smart pers- koppelingen



Persbekken MLC UPP1 en KSP0



S-Press en S-Press- PLUS koppelingen



Vario/Fit 14x2,0	M12 & M18	natural eval	14	14	-
Vario/Fit 16x2,0	M12 & M18	natural eval	16	16	-
Vario/Fit 17x2,0	M12 & M18	natural eval & wit	17	-	-
Vario/Fit 20x1,9/2,0	M12 & M18	natural eval & wit	-	20	-
Vario/Fit 16x1,8/2,0	M12 & M18	natur eval & wit	16	16	-
Vario/Fit 20x1,9/2,0	M12 & M18	natur eval & wit	-	20	-
Flex-X 16x2,2	M12 & M18	wit	-	-	-
Flex-X 20x2,8	M12 & M18	wit	-	-	-
Vario/Fit 14x2,0	M12 & M18	natural eval	14	14	-
Vario/Fit 16x1,8/2,0	M12 & M18	natural eval & wit	16	16	-
Vario/Fit 20x1,9/2,0	M12 & M18	natural eval & wit	-	20	-
Vario/Fit 25x2,3	M12 & M18	natural eval & wit	25	-	-
Vario & Minitec 9,9 x 1,1	Hand, M12 & M18	Minitec PEX	-	-	-
Uni-X 14-3/4 Euro	-	-	-	-	14
Vario MLCP RED 14x1,6 Euro	-	-	-	-	14 MLCP RED koppeling
Uni-X 16-3/4 Euro	-	-	-	-	16
Uni-X 16-3/4 Euro	-	-	-	-	16

Uponor 10 bar UFH vloerverwarming

art.nr.	omschrijving	LE	VPE	eenheid
---------	--------------	----	-----	---------

Uponor Comfort Pipe PN10

 1119470	16x2,2 240m	1440	240	m
1119471	16x2,2 640m	1280	640	m
1119472	20x2,8 240m	960	240	m
1119533	20x2,8 480m	960	480	m

Uponor Flex-X schroefkoppeling Euroconus PEX

 1045542	16x2,2-3/4"FT Euro	100	10	set
1045543	20x2,8-3/4"FT Euro	100	10	set

Uponor Q&E koppeling PPSU

 1008669	16-16	100	5	st.
1008932	20-20	80	5	st.

Uponor Q&E zekeringsring white

 1057453	16	900	20	st.
1057454	20	520	20	st.

art.nr.	omschrijving	LE	VPE	eenheid
---------	--------------	----	-----	---------

Uponor Q&E expansiegereedschap met expansiekop M12/



1119379	16RS/20/25 10bar	-	1	set
----------------	------------------	---	---	-----

Uponor Q&E expansiekop M12/M18/Rapid Seal



1119381	16x1,8/2,0/2,2	-	1	st.
1119383	20x2,8	-	1	st.

Uponor Minitec

art.nr.	omschrijving	LE	VPE	eenheid	prijs/eenheid
---------	--------------	----	-----	---------	---------------

Uponor Minitec folie-element

	1005261 15,4m ² 9,9x1,1 1100x700x12mm	123,2	15,4	m ²	
---	---	-------	------	----------------	--

Uponor Fix Klemmenstrook

	1005274 9,9mm c/c20mm 2,5m	25	2,5	m	
---	-----------------------------------	----	-----	---	--

Uponor Minitec randisolatie

	1005267 20m 80x8mm	200	20	m	
---	---------------------------	-----	----	---	--

Uponor Minitec dilatatievoegprofiel

	1085980 0,9m 40x10mm	600	10	st.	
	1085981 1,3m 40x10mm	600	10	st.	

Uponor Minitec leiding Comfort Pipe

	1063287 9,9x1,1 60m	840	60	m	
	1063288 9,9x1,1 120m	1680	120	m	
	1063381 9,9x1,1 480m	2880	480	m	

Uponor Minitec leiding mantelbuisfolie

	1005269 9,9mm 300x2mm	3600	30	st.	
---	------------------------------	------	----	-----	--

Uponor Vario Euroconus schroefkoppeling Minitec

	1005266 9,9x1,1-G $\frac{3}{4}$ "Euro	100	10	st.	
---	--	-----	----	-----	--

Uponor Minitec koppeling

	1005264 9,9x1,1	100	10	st.	
---	------------------------	-----	----	-----	--

Uponor Minitec puntstuk

	1005265 9,9-R $\frac{1}{2}$ "MT	100	10	st.	
---	--	-----	----	-----	--

Uponor Minitec ring

	1005263 9,9x1,1	1600	10	st.	
---	------------------------	------	----	-----	--

Uponor Minitec klemringschroefkoppeling

	1013426 9,9- $\frac{3}{4}$ "Euro	120	12	st.	
---	---	-----	----	-----	--

Uponor Fluvia schroef-Y-stuk

	1005675 2xG $\frac{3}{4}$ - $\frac{3}{4}$ "Euro	50	1	set	
---	--	----	---	-----	--

art.nr.	omschrijving	LE	VPE	eenheid
---------	--------------	----	-----	---------

Uponor Fluvia T pompgroep Push-12 AC-G

	1095128	60	1	st.
---	----------------	----	---	-----

Uponor Vario vul- en aftapkraan

	1061802 $\frac{3}{4}$ " - $\frac{3}{4}$ "	10	1	set
---	--	----	---	-----

Uponor Multi Leiding geleidingsbocht

	NEW 1135490 10-12	360	60	st.
---	---------------------------------	-----	----	-----

Uponor Minitec aansluitbox inbouwuitvoering

	1005270 1X	30	1	st.
	1005271 2X	-	1	st.
	1005272 3X	-	1	st.

De begrenzing van de berekende temperatuur dient door een voorregeling zeker gesteld te worden.

Uponor Minitec afdekplaat

	1007251	-	1	st.
--	----------------	---	---	-----

Uponor Base ruimtethermostaat T-23

	1058422 230V RAL9010	160	1	st.
---	-----------------------------	-----	---	-----

Uponor Minitec expansiegereedschap

	1006247 9,9x1,1	11	1	set
---	------------------------	----	---	-----

Uponor Q&E expansiegereedschap met expansiekop M12

	OUT 1063112 6BAR 9,9/20	-	1	set
---	---------------------------------------	---	---	-----

OUT Artikel is uitlopend.
Levering zolang de voorraad strekt.

Uponor Q&E RS expansiegereedschap met expansiekop M12

	NEW 1119375 6bar 9,9RS/20	-	1	set
---	---	---	---	-----

Uponor Tecto

art.nr.	omschrijving	LE	VPE	eenheid
---------	--------------	----	-----	---------

Uponor Tecto noppenplaat

 1005478	EPS DES 30-2mm 14-17mm 1450x850mm	53,76	8,96	m ²
1005477	EPS 11mm 14-17mm 1450x850mm	94,08	15,68	m ²

Uponor Tecto diagonale leidinghouder

 1005482	45 75mm	420	10	st.
--	---------	-----	----	-----

Uponor Tecto koppelstrook

 1005484	1,4m 100mm	742,5	33,75	m
--	------------	-------	-------	---

Uponor Tecto afdekkfolie

 1005481	1,45m 200mm	504	28	m
--	-------------	-----	----	---

Uponor Tecto isolatiestrook

 1005480	EPS DES 30-2mm 150x1400mm	268,8	8,4	m
1005479	EPS 11mm 150x1400mm	716,8	22,4	m

Uponor Multi randisolatie met foliestrook

 1000079	150x8mm	-	200	m
--	---------	---	-----	---

Uponor Multi randisolatie met foliestrook

 1000080	150x10mm	-	200	m
--	----------	---	-----	---

Uponor Multi dilatatieprofiel

 1090229	1800x100x10mm	720	18	m
--	---------------	-----	----	---

Uponor Multi beschermingsmantel

 1000082	20mm 300x5mm	10800	30	st.
--	--------------	-------	----	-----

art.nr.	omschrijving	LE	VPE	eenheid
---------	--------------	----	-----	---------

Uponor Comfort Pipe PLUS Blue leiding

 1126541	16x2,0 640 m	640	640	m
--	--------------	-----	-----	---

Uponor Comfort Pipe PLUS leiding

 1062883	14x2,0 120m	1320	120	m
1062884	14x2,0 240m	1680	240	m
1088166	14x2,0 640m	1920	640	m
1062885	14x2,0 960m	1920	960	m
1062044	16x2,0 120m	1080	120	m
1062045	16x2,0 240m	1440	240	m
1062046	16x2,0 640m	1280	640	m
1034535	17x2,0 120m	840	120	m
1009226	17x2,0 240m	1200	240	m
1086340	17x2,0 480m	960	480	m
1009227	17x2,0 640m	1280	640	m

Uponor Vario klemringschroefkoppeling PEX

 1065283	14x2,0-G ³ / ₄ "FT Euro	25	1	st.
1065284	16x1,8/2,0-G ³ / ₄ "FT Euro	25	1	st.
1065286	17x2,0-G ³ / ₄ "FT Euro	25	1	st.

Uponor Fit schroefkoppeling PEX

 1065296	16x1,8/2,0-16x1,8/2,0	25	1	st.
1065299	17x2,0-17x2,0	25	1	st.

Uponor Fit klemovergangspuntstuk PEX

 1065294	14x2,0-R ¹ / ₂ "MT	25	1	st.
1065297	16x1,8/2,0-R ¹ / ₂ "MT	25	1	st.
1065300	17x2,0-R ¹ / ₂ "MT	25	1	st.

Uponor Fit klemovergangsschroefbus PEX

 1065295	14x2,0-Rp ¹ / ₂ "FT	25	1	st.
1065298	16x1,8/2,0-Rp ¹ / ₂ "FT	25	1	st.

Uponor Tecto

art.nr.	omschrijving	LE	VPE	eenheid	prijs/eenheid
---------	--------------	----	-----	---------	---------------

Uponor Rapex perskoppeling

 1005079	17-17	100	10	st.	
--	-------	-----	----	-----	--

Voor het maken van de persverbinding de volgende Uponor persbekken toepassen (zie Uponor gereedschap):

Uponor persbek voor 17 x 2 mm PE-X artikelnummer 1006343

Uponor Q&E koppeling met ringen DR

 1058659	14-14	100	10	st.	
1058660	16x1,8/2,0-16x1,8/2,0	100	10	st.	
1058661	17-17	100	10	st.	

Uponor Q&E ring met stop-edge natural, eval

 1058428	14	900	20	st.	
--	----	-----	----	-----	--

Uponor Smart perskoppeling

 1089646	14x2,0-14x2,0	80	20	st.	
1089647	16x1,8/2,0-16x1,8/2,0	80	20	st.	

Let op: pers met Uponor S-Press persbekken UPP1 voor Uponor MLC perskoppelingen of mini persbekken KSP0

art.nr.	omschrijving	LE	VPE	eenheid	
---------	--------------	----	-----	---------	--

Uponor MLCP RED leiding

 1096010	14x1,6 240m	3120	240	m	
1096011	14x1,6 480m	3360	480	m	
1096012	16x2,0 240m	3120	240	m	
1096013	16x2,0 480m	3360	480	m	

Uponor Vario klemkoppeling MLCP RED

 1000117	14x1,6-3/4" Euro	80	20	st.	
--	------------------	----	----	-----	--

Uponor MLCP RED perskoppeling

 1048272	14x1,6-14x1,6	80	20	st.	
--	---------------	----	----	-----	--

Uponor S-Press PLUS koppeling

 1070547	16-16	80	20	st.	
--	-------	----	----	-----	--

Uponor S-Press PLUS koppeling PPSU

 1039933	16-16	80	20	st.	
--	-------	----	----	-----	--

Uponor Uni-X schroefkoppeling MLC

 1058090	16-3/4" FT Euro	25	1	st.	
--	-----------------	----	---	-----	--

Uponor Multi Leiding geleidingsbocht

 NEW 1135491	14-18	240	30	st.	
---	-------	-----	----	-----	--

Uponor Nubos

art.nr.	omschrijving	LE	VPE	eenheid
---------	--------------	----	-----	---------

Uponor Nubos noppenplaat

 1016699	EPS 30-2 14-16mm 1447x900x48mm	60	10	m ²
1016700	EPS 11 14-16mm 1447x900x29mm	100	10	m ²

Uponor Nubos noppenfolie

 1016703	14-16mm	140	10	m ²
1061880	14-16mm	-	200	m ²

Uponor Nubos noppenplaat verd./deurset

 1016701	EPS 30-2 14-16mm 1447x900x48mm	50	5	m ²
1016702	EPS 11 14-16mm 1447x900x29mm	50	5	m ²

Uponor Multi randisolatie met foliestrook

 1000079	150x8mm	-	200	m
--	---------	---	-----	---

Uponor Multi randisolatie met foliestrook

 1000080	150x10mm	-	200	m
--	----------	---	-----	---

Uponor Multi dilatatieprofiel

 1090229	1800x100x10mm	720	18	m
--	---------------	-----	----	---

Uponor Multi beschermingsmantel

 1000082	20mm 300x5mm	10800	30	st.
--	--------------	-------	----	-----

Uponor Fix Klemmenstrook met kleefstrip

 NEW 1135496	16-20mm c/c 50mm 1m	2000	100	st.
--	------------------------	------	-----	-----

Uponor Comfort Pipe PLUS Blue leiding

 1126541	16x2,0 640 m	640	640	m
--	--------------	-----	-----	---



Uponor Comfort Pipe PLUS leiding

 1062883	14x2,0 120m	1320	120	m
1062884	14x2,0 240m	1680	240	m
1088166	14x2,0 640m	1920	640	m
1062885	14x2,0 960m	1920	960	m
1062044	16x2,0 120m	1080	120	m
1062045	16x2,0 240m	1440	240	m
1062046	16x2,0 640m	1280	640	m

art.nr.	omschrijving	LE	VPE	eenheid
---------	--------------	----	-----	---------

Uponor Vario klemringschroefkoppeling PEX

 1065283	14x2,0-G ³ / ₄ "FT Euro	25	1	st.
1065284	16x1,8/2,0-G ³ / ₄ "FT Euro	25	1	st.

Uponor Fit Schroefkoppeling PEX

 1065296	16x1,8/2,0-16x1,8/2,0	25	1	st.
--	-----------------------	----	---	-----

Uponor Fit klemovergangsschroefbus PEX

 1065298	16x1,8/2,0-Rp ¹ / ₂ "FT	25	1	st.
--	---	----	---	-----

Uponor Q&E koppeling met ringen DR

 1058660	16x1,8/2,0-16x1,8/2,0	100	10	st.
--	-----------------------	-----	----	-----

Uponor Smart perskoppeling

 1089646	14x2,0-14x2,0	80	20	st.
1089647	16x1,8/2,0-16x1,8/2,0	80	20	st.

Let op: pers met Uponor S-Press persbekken UPP1 voor Uponor MLC perskoppelingen of mini persbekken KSP0

Uponor MLCP RED leiding

 1096010	14x1,6 240m	3120	240	m
1096011	14x1,6 480m	3360	480	m
1096012	16x2,0 240m	3120	240	m
1096013	16x2,0 480m	3360	480	m

Uponor Vario klemkoppeling MLCP RED

 1000117	14x1,6- ³ / ₄ "Euro	80	20	st.
--	---	----	----	-----

Uponor MLCP RED perskoppeling

 1048272	14x1,6-14x1,6	80	20	st.
--	---------------	----	----	-----

Uponor Uni-X schroefkoppeling MLC

 1058090	16- ³ / ₄ "FT Euro	25	1	st.
--	--	----	---	-----

Uponor S-Press PLUS koppeling

 1070547	16-16	80	20	st.
--	-------	----	----	-----

Uponor S-Press PLUS koppeling PPSU

 1039933	16-16	80	20	st.
--	-------	----	----	-----

Uponor Multi Leiding geleidingsbocht

 NEW 1135491	14-18	240	30	st.
--	-------	-----	----	-----

Uponor Klett

art.nr.	omschrijving	LE	VPE	eenheid	prijs/eenheid
---------	--------------	----	-----	---------	---------------

Uponor Klett rol extra

 1063402	EPS DES 25-2mm 10x1m	80	10	m ²	
1063322	EPS DES 30-2mm 10x1m	80	10	m ²	
1063323	EPS DES 30-3mm 10x1m	80	10	m ²	
1063324	EPS DES 35-3mm 10x1m	70	10	m ²	

Uponor Klett dubbele plaat

 1086854	2400x1000x3mm	360	24	m ²	
--	---------------	-----	----	----------------	--

Uponor Klett plaat Silent

 1088065	1200x1000x30mm	48	4,8	m ²	
--	----------------	----	-----	----------------	--

Uponor Multi randisolatie met foliestrook

 1000079	150x8mm	-	200	m	
--	---------	---	-----	---	--

Uponor Multi randisolatie met foliestrook

 1000080	150x10mm	-	200	m	
--	----------	---	-----	---	--

Uponor Klett randisolatie

 1089919	1200X120X13mm	1536	96	m	
--	---------------	------	----	---	--

Uponor Klett afdichtfolie

 1089951	50m 280x0,2mm	6000	50	m	
--	---------------	------	----	---	--

Uponor Multi dilatatieprofiel

 1090229	1800x100x10mm	720	18	m	
--	---------------	-----	----	---	--

Uponor Multi beschermingsmantel

 1000082	20mm 300x5mm	10800	30	st.	
--	--------------	-------	----	-----	--

art.nr.	omschrijving	LE	VPE	eenheid
---------	--------------	----	-----	---------

Uponor Klett leiding Comfort Pipe PLUS

 1088479	14x2,0 240m	1440	240	m
1088480	14x2,0 640m	1280	640	m
1087302	16x2,0 240m	1200	240	m
1087303	16x2,0 640m	1280	640	m

Uponor Vario klemringschroefkoppeling PEX

 1065283	14x2,0-G $\frac{3}{4}$ "FT Euro	25	1	st.
1065284	16x1,8/2,0-G $\frac{3}{4}$ "FT Euro	25	1	st.

Uponor Smart perskoppeling

 1089646	14x2,0-14x2,0	80	20	st.
1089647	16x1,8/2,0-16x1,8/2,0	80	20	st.

Let op: pers met Uponor S-Press persbekken UPP1 voor Uponor MLC perskoppelingen of mini persbekken KSP0

Uponor Fit schroefkoppeling PEX

 1065296	16x1,8/2,0-16x1,8/2,0	25	1	st.
--	-----------------------	----	---	-----

Uponor Fit klemovergangspuntstuk PEX

 1065294	14x2,0-R $\frac{1}{2}$ "MT	25	1	st.
1065297	16x1,8/2,0-R $\frac{1}{2}$ "MT	25	1	st.

Uponor Fit klemovergangsschroefbus PEX

 1065295	14x2,0-Rp $\frac{1}{2}$ "FT	25	1	st.
1065298	16x1,8/2,0-Rp $\frac{1}{2}$ "FT	25	1	st.

Uponor Q&E koppeling met ringen DR

 1058659	14-14	100	10	st.
1058660	16x1,8/2,0-16x1,8/2,0	100	10	st.

Uponor Q&E ring met stop-edge natural, eval

 1058428	14	900	20	st.
--	----	-----	----	-----

Uponor Q&E zekeringsring white

 1057453	16	900	20	st.
--	----	-----	----	-----

Uponor Klett

art.nr.	omschrijving	LE	VPE	eenheid
---------	--------------	----	-----	---------

Uponor Klett leiding MLCP RED

 1096014	16X2,0 240M	1920	240	m
1096015	16X2,0 480M	2400	480	m

Uponor Uni-X schroefkoppeling MLC

 1058090	16-3/4"FT Euro	25	1	st.
--	----------------	----	---	-----

Uponor S-Press PLUS koppeling

 1070547	16-16	80	20	st.
--	-------	----	----	-----

Uponor S-Press PLUS koppeling PPSU

 1039933	16-16	80	20	st.
--	-------	----	----	-----

art.nr.	omschrijving	LE	VPE	eenheid
---------	--------------	----	-----	---------

Uponor Multi plakband

 1000012	66m 50mm	36	1	st.
--	----------	----	---	-----

Uponor Multi plakbandroller

 1000142		20	1	st.
--	--	----	---	-----

Uponor Multi Leiding geleidingsbocht

 NEW 1135491	14-18	240	30	st.
---	-------	-----	----	-----

Uponor Multi leidinggeleider

 1088066		-	1	st.
---	--	---	---	-----

Uponor Tacker

art.nr.	omschrijving	LE	VPE	eenheid	prijs/eenheid
---------	--------------	----	-----	---------	---------------

Uponor Tacker rol

 1090921	EPS DES 20-2mm 10x1m	100	10	m ²	
1090924	EPS DES 30-2mm 10x1m	80	10	m ²	
1090925	EPS DES 30-3mm 10x1m	80	10	m ²	
1090926	EPS DES 35-3mm 10x1m	70	10	m ²	
1090927	EPS DES 40-3mm 10x1m	60	10	m ²	

Uponor Tacker plaat

 1090917	EPS DEO 20	100	10	m ²	
1090918	EPS DEO 30	80	10	m ²	

Uponor Tacker Folie transparant

 1122372	0,2mm 100x1,03m	2884	103	m ²	
--	-----------------	------	-----	----------------	--

Uponor Multi randisolatie met foliestrook

 1000079	150x8mm	-	200	m	
---	---------	---	-----	---	--

Uponor Multi randisolatie met foliestrook

 1000080	150x10mm	-	200	m	
--	----------	---	-----	---	--

Uponor Multi dilatatieprofiel

 1090229	1800x100x10mm	720	18	m	
--	---------------	-----	----	---	--

Uponor Multi beschermingsmantel

 1000082	20mm 300x5mm	10800	30	st.	
--	--------------	-------	----	-----	--

Uponor Multi plakband



 1000012	66m 50mm	36	1	st.	
--	----------	----	---	-----	--

Uponor Multi plakbandroller

 1000142		20	1	st.	
--	--	----	---	-----	--

art.nr.	omschrijving	LE	VPE	eenheid
---------	--------------	----	-----	---------

Uponor Comfort Pipe PLUS Blue leiding

 1126541	16x2,0 640 m	640	640	m
 1126542	20x2,0 480 m	480	480	m



Uponor Comfort Pipe PLUS leiding

 1062883	14x2,0 120m	1320	120	m
1062884	14x2,0 240m	1680	240	m
1088166	14x2,0 640m	1920	640	m
1062885	14x2,0 960m	1920	960	m
1062044	16x2,0 120m	1080	120	m
1062045	16x2,0 240m	1440	240	m
1062046	16x2,0 640m	1280	640	m
1034535	17x2,0 120m	840	120	m
1009226	17x2,0 240m	1200	240	m
1009227	17x2,0 640m	1280	640	m

Uponor Magna pipe PLUS

 1091275	20x2,0 240m	960	240	m
1091276	20x2,0 480m	960	480	m

Uponor Vario klemringschroefkoppeling PEX

 1065283	14x2,0-G ³ / ₄ "FT Euro	25	1	st.
1065284	16x1,8/2,0-G ³ / ₄ "FT Euro	25	1	st.
1065286	17x2,0-G ³ / ₄ "FT Euro	25	1	st.
1065290	20x1,9/2,0-G ³ / ₄ "FT Euro	25	1	st.

Uponor Fit schroefkoppeling PEX

 1065296	16x1,8/2,0-16x1,8/2,0	25	1	st.
1065299	17x2,0-17x2,0	25	1	st.
1065302	20x1,9/2,0-20x1,9/2,0	25	1	st.

Uponor Smart perskoppeling

 1089646	14x2,0-14x2,0	80	20	st.
1089647	16x1,8/2,0-16x1,8/2,0	80	20	st.

Let op: pers met Uponor S-Press persbekken UPP1 voor Uponor MLC perskoppelingen of mini persbekken KSP0

Uponor Fit klemovergangspuntstuk PEX

 1065294	14x2,0-R ¹ / ₂ "MT	25	1	st.
1065297	16x1,8/2,0-R ¹ / ₂ "MT	25	1	st.
1065300	17x2,0-R ¹ / ₂ "MT	25	1	st.
1065305	20x1,9/2,0-R ³ / ₄ "MT	25	1	st.

Uponor Tacker

art.nr.	omschrijving	LE	VPE	eenheid
---------	--------------	----	-----	---------

Uponor Fit klemovergangsschroefbus PEX

 1065295	14x2,0-Rp½"FT	25	1	st.
1065298	16x1,8/2,0-Rp½"FT	25	1	st.
1065306	20x1,9/2,0-Rp¾"FT	25	1	st.

Uponor Rapex perskoppeling

 1005079	17-17	100	10	st.
--	-------	-----	----	-----

Voor het maken van de persverbinding de volgende Uponor persbekken toepassen (zie Uponor gereedschap):

Uponor persbek voor 17 x 2 mm PE-X artikelnummer 1006343

Uponor Q&E koppeling met ringen DR

 1058660	16x1,8/2,0-16x1,8/2,0	100	10	st.
1058661	17-17	100	10	st.

Uponor MLCP RED leiding

 1096010	14x1,6 240m	3120	240	m
1096011	14x1,6 480m	3360	480	m
1096012	16x2,0 240m	3120	240	m
1096013	16x2,0 480m	3360	480	m

Uponor Vario klemkoppeling MLCP RED

 1000117	14x1,6-¾"Euro	80	20	st.
--	---------------	----	----	-----

Uponor MLCP RED perskoppeling

 1048272	14x1,6-14x1,6	80	20	st.
--	---------------	----	----	-----

Uponor Uni-X schroefkoppeling MLC

 1058090	16-¾"FT Euro	25	1	st.
--	--------------	----	---	-----

Uponor S-Press PLUS koppeling

 1070547	16-16	80	20	st.
--	-------	----	----	-----

Uponor S-Press PLUS koppeling PPSU

 1039933	16-16	80	20	st.
--	-------	----	----	-----

art.nr.	omschrijving	LE	VPE	eenheid
---------	--------------	----	-----	---------

Uponor Tacker Tacker naald kort

 NEW 1135487	14-17mm h=35mm	8400	300	st.
---	-------------------	------	-----	-----

Uponor Tacker clips

 1086529	14-20mm h=40mm	75000	1000	st.
--	----------------	-------	------	-----

Uponor Tacker Nietmachine naald lang

 NEW 1135489	14-20mm h=50mm	5000	250	st.
---	-------------------	------	-----	-----

Uponor Tacker Tool

 1119039	14-20mm	50	1	st.
---	---------	----	---	-----

Uponor Multi Leiding geleidingsbocht

 NEW 1135491	14-18	240	30	st.
NEW 1135492	20-22	140	35	st.

Uponor Fix

art.nr.	omschrijving	LE	VPE	eenheid	prijs/eenheid
---------	--------------	----	-----	---------	---------------

Uponor Fix Klemmenstrook met kleefstrip

 NEW 1135496	16-20mm c/c 50mm 1m	2000	100	st.	
--	------------------------	------	-----	-----	--

Uponor Fix Klemmenstrook

 1005498	14mm c/c/50mm 2,5m	-	25	m	
---	--------------------	---	----	---	--

Uponor Fix Klemmenstrook

 1005274	9,9mm c/c/20mm 2,5m	25	2,5	m	
---	---------------------	----	-----	---	--

Uponor Comfort Pipe PLUS leiding

 1062883	14x2,0 120m	1320	120	m	
1062884	14x2,0 240m	1680	240	m	
1062885	14x2,0 960m	1920	960	m	
1009229	20x2,0 60m	660	60	m	

Uponor Minitec leiding Comfort Pipe

 1063287	9,9x1,1 60m	840	60	m	
1063288	9,9x1,1 120m	1680	120	m	
1063381	9,9x1,1 480m	2880	480	m	

Uponor Magna pipe PLUS

 1091275	20x2,0 240m	960	240	m	
1091276	20x2,0 480m	480		m	

Uponor Vario klemringschroefkoppeling PEX

 1065283	14x2,0-G $\frac{3}{4}$ "FT Euro	25	1	st.	
1065290	20x1,9/2,0-G $\frac{3}{4}$ "FT Euro	25	1	st.	

Uponor Smart perskoppeling

 1089646	14x2,0-14x2,0	80	20	st.	
---	---------------	----	----	-----	--

Let op: pers met Uponor S-Press persbekken UPP1 voor Uponor MLC perskoppelingen of mini persbekken KSP0

Uponor Fit klemovergangspuntstuk PEX

 1065294	14x2,0-R $\frac{1}{2}$ "MT	25	1	st.	
---	----------------------------	----	---	-----	--

Uponor Fit klemovergangsschroefbus PEX

 1065295	14x2,0-Rp $\frac{1}{2}$ "FT	25	1	st.	
---	-----------------------------	----	---	-----	--

Uponor Q&E koppeling met ringen DR

 1058659	14-14	100	10	st.	
---	-------	-----	----	-----	--

Uponor Q&E ring met stop-edge natural, eval

 1058428	14	900	20	st.	
---	----	-----	----	-----	--

Uponor Q&E zekeringsring white

 1057454	20	520	20	st.	
---	----	-----	----	-----	--

art.nr.	omschrijving	LE	VPE	eenheid	
---------	--------------	----	-----	---------	--

Uponor MLCP RED leiding

 1096010	14x1,6 240m	3120	240	m	
1096011	14x1,6 480m	3360	480	m	

Uponor Vario klemkoppeling MLCP RED

 1000117	14x1,6- $\frac{3}{4}$ "Euro	80	20	st.	
---	-----------------------------	----	----	-----	--

Uponor MLCP RED perskoppeling

 1048272	14x1,6-14x1,6	80	20	st.	
---	---------------	----	----	-----	--

Uponor Minitec ring

 1005263	9,9x1,1	1600	10	st.	
---	---------	------	----	-----	--

Uponor Vario Euroconus schroefkoppeling Minitec

 1005266	9,9x1,1-G $\frac{3}{4}$ "Euro	100	10	st.	
---	-------------------------------	-----	----	-----	--

Uponor Minitec koppeling

 1005264	9,9x1,1	100	10	st.	
---	---------	-----	----	-----	--

Uponor Minitec T-stuk verlopend Q&E

 1020524	20xMinitec9,9xQ&E20	75	5	st.	
---	---------------------	----	---	-----	--

Uponor Minitec puntstuk

 1005265	9,9-R $\frac{1}{2}$ "MT	100	10	st.	
---	-------------------------	-----	----	-----	--

Uponor Minitec koppeling verlopend Q&E

 1020518	20xMinitec9,9	150	5	st.	
---	---------------	-----	---	-----	--

Uponor Minitec Compressiefitting

 1013426	9,9- $\frac{3}{4}$ "Euro	120	12	st.	
---	--------------------------	-----	----	-----	--

Uponor Minitec expansiegereedschap

 1006247	9,9x1,1	11	1	set	
---	---------	----	---	-----	--

Uponor Q&E RS expansiegereedschap met expansiekop M12

 1119375	6bar 9,9RS/20	-	1	set	
---	---------------	---	---	-----	--

Uponor Multi Leiding geleidingsbocht

 NEW 1135490	10-12	360	60	st.	
NEW 1135491	14-18	240	30	st.	
NEW 1135492	20-22	140	35	st.	

Uponor Classic

art.nr.	omschrijving	LE	VPE	eenheid
---------	--------------	----	-----	---------

Uponor Classic Draagelement

 1005084	100mm 2100x1200x3mm	750	25	m ²
1005087	150mm 2100x1200x3mm	750	25	m ²

Uponor Classic mattenbinder

 1007393	80mm (100pce/set)	2500	50	set
--	-------------------	------	----	-----

Uponor Classic masterclip, draadstaamat

 1005188	16mm 3mm	500	500	st.
1005189	17mm 3mm	500	500	st.
1005190	20mm 3mm	2800	280	st.

Uponor Multi randisolatie met foliestrook

 1000079	150x8mm	-	200	m
--	---------	---	-----	---

Uponor Multi randisolatie met foliestrook

 1000080	150x10mm	-	200	m
--	----------	---	-----	---

Uponor Multi dilatatieprofiel



 1090229	1800x100x10mm	720	18	m
--	---------------	-----	----	---

Uponor Multi beschermingsmantel

 1000082	20mm 300x5mm	10800	30	st.
--	--------------	-------	----	-----

Uponor Comfort Pipe PLUS Blue leiding



 1126541	16x2,0 640 m	640	640	m	4,24
 1126542	20x2,0 480 m	480	480	m	5,11

Uponor Comfort Pipe PLUS leiding

 1062044	16x2,0 120m	1080	120	m
1062045	16x2,0 240m	1440	240	m
1062046	16x2,0 640m	1280	640	m
1034535	17x2,0 120m	840	120	m
1009226	17x2,0 240m	1200	240	m
1086340	17x2,0 480m	960	480	m
1009227	17x2,0 640m	1280	640	m

Uponor Magna pipe PLUS

 1091275	20x2,0 240m	960	240	m
1091276	20x2,0 480m	960	480	m

Uponor Vario klemringschroefkoppeling PEX

 1065284	16x1,8/2,0-G ³ / ₄ "FT Euro	25	1	st.
1065286	17x2,0-G ³ / ₄ "FT Euro	25	1	st.
1065290	20x1,9/2,0-G ³ / ₄ "FT Euro	25	1	st.

art.nr.	omschrijving	LE	VPE	eenheid
---------	--------------	----	-----	---------

Uponor Fit schroefkoppeling PEX

 1065296	16x1,8/2,0-16x1,8/2,0	25	1	st.
1065299	17x2,0-17x2,0	25	1	st.
1065302	20x1,9/2,0-20x1,9/2,0	25	1	st.

Uponor Smart perskoppeling

 1089647	16x1,8/2,0-16x1,8/2,0	80	20	st.
1089648	20x2,0-20x2,0	80	20	st.

Let op: pers met Uponor S-Press persbekken UPP1 voor Uponor MLC perskoppelingen of mini persbekken KSP0

Uponor Fit klemovergangspuntstuk PEX

 1065297	16x1,8/2,0-R ¹ / ₂ "MT	25	1	st.
1065300	17x2,0-R ¹ / ₂ "MT	25	1	st.
1065305	20x1,9/2,0-R ³ / ₄ "MT	25	1	st.

Uponor Fit klemovergangsschroefbus PEX

 1065298	16x1,8/2,0-Rp ¹ / ₂ "FT	25	1	st.
1065306	20x1,9/2,0-Rp ³ / ₄ "FT	25	1	st.

Uponor Rapex perskoppeling

 1005079	17-17	100	10	st.
--	-------	-----	----	-----

Voor het maken van de persverbinding de volgende Uponor persbekken toepassen (zie Uponor gereedschap):

Uponor persbek voor 17 x 2 mm PE-X artikelnummer 1006343

Uponor Q&E koppeling met ringen DR

 1058660	16x1,8/2,0-16x1,8/2,0	100	10	st.
1058661	17-17	100	10	st.
1058668	20-20	80	10	st.

Uponor Multi Leiding geleidingsbocht

 NEW 1135491	14-18	240	30	st.
NEW 1135492	20-22	140	35	st.

Uponor Classic Clipmaster

 1062295	16/17mm l=920mm	100	1	st.
106309	20mm l=920mm	-	1	st.

Uponor Classic drilapparaat voor matbinders

 1066243	l=320mm	50	1	st.
--	---------	----	---	-----

Uponor Siccus 14

art.nr.	omschrijving	LE	VPE	eenheid	prijs/eenheid
---------	--------------	----	-----	---------	---------------

Uponor Siccus 14 montageplaat

 1005485	EPS 150kPa 14mm 1197x1050x25mm	100	12,5	m ²	
--	-----------------------------------	-----	------	----------------	--

Uponor Siccus 14 warmtegeleidingslamel

 1005486	14mm 1180x120x0,45mm	768	48	st.	
--	-------------------------	-----	----	-----	--

Uponor Multi randisolatie met foliestrook

 1000079	150x8mm	-	200	m	
--	---------	---	-----	---	--

Uponor Comfort Pipe PLUS leiding

 1062883	14x2,0 120m	1320	120	m	
1062884	14x2,0 240m	1680	240	m	
1088166	14x2,0 640m	1920	640	m	
1062885	14x2,0 960m	1920	960	m	

Uponor Vario klemringschroefkoppeling PEX

 1065283	14x2,0-G $\frac{3}{4}$ "FT Euro	25	1	st.	
--	---------------------------------	----	---	-----	--

Uponor Fit klemovergangspuntstuk PEX

 1065294	14x2,0-R $\frac{1}{2}$ "MT	25	1	st.	
--	----------------------------	----	---	-----	--

Uponor Fit klemovergangsschroefbus PEX

 1065295	14x2,0-Rp $\frac{1}{2}$ "FT	25	1	st.	
--	-----------------------------	----	---	-----	--

Uponor Q&E koppeling met ringen DR

 1058659	14-14	100	10	st.	
--	-------	-----	----	-----	--

Uponor Q&E ring met stop-edge natural, eval

 1058428	14	900	20	st.	
--	----	-----	----	-----	--

Uponor Smart perskoppeling

 1089646	14x2,0-14x2,0	80	20	st.	
--	---------------	----	----	-----	--

Let op: pers met Uponor S-Press persbekken UPP1 voor Uponor MLC perskoppelingen of mini persbekken KSP0

art.nr.	omschrijving	LE	VPE	eenheid
---------	--------------	----	-----	---------

Uponor MLCP RED leiding

 1096010	14x1,6 240m	3120	240	m
1096011	14x1,6 480m	3360	480	m

Uponor Vario klemkoppeling MLCP RED

 1000117	14x1,6- $\frac{3}{4}$ "Euro	80	20	st.
--	-----------------------------	----	----	-----

Uponor MLCP RED perskoppeling

 1048272	14x1,6-14x1,6	80	20	st.
--	---------------	----	----	-----

Uponor Multi Leiding geleidingsbocht

 NEW 1135491	14-18	240	30	st.
---	-------	-----	----	-----

Uponor Siccus 14 polystyreensnijder

 1006290	14mm 230V	20	1	st.
--	-----------	----	---	-----

Uponor Renovis

art.nr.	omschrijving	LE	VPE	eenheid
Uponor Renovis Panel				
 1061173	800x625mm	-	24	st.
1061172	1200x625mm	-	24	st.
1061171	2000x625mm	-	24	st.

Uponor Renovis Panel extra				
 1063923	800x625x15mm	24	1	st.
1063924	1200x625x15mm	24	1	st.
1063925	2000x625x15mm	24	1	st.

Uponor Renovis Panel				
 1063926	2000x625x15mm	-	24	st.

Uponor Renovis aansluitpakket				
 1061165	4-6X	10	1	set
Ter informatie: de in de omschrijving genoemde „4-6 loop“ betekend: 4-6 groepen				

Uponor Fix Klemmenstrook				
 1005274	9,9mm c/c20mm 2,5m	25	2,5	m

Uponor Renovis klemprofiel				
 1061162	20mm l=250mm	-	15	st.

Uponor Minitec leiding Comfort Pipe				
 1063287	9,9x1,1 60m	840	60	m
1063288	9,9x1,1 120m	1680	120	m

Uponor Minitec puntstuk				
 1005265	9,9-R $\frac{1}{2}$ \" data-bbox="73 671 125 687"/> 1005265	100	10	st.

Uponor Minitec koppeling				
 1005264	9,9x1,1	100	10	st.

Uponor Minitec ring				
 1005263	9,9x1,1	1600	10	st.

art.nr.	omschrijving	LE	VPE	eenheid
Uponor Comfort Pipe PLUS leiding				
 1009229	20x2,0 60m	660	60	m

Uponor Magna pipe PLUS				
 1091275	20x2,0 240m	960	240	m
1091276	20x2,0 480m	960	480	m

Uponor Minitec T-stuk verlopend Q&E				
 1020524	20xMinitec9,9xQ&E20	75	5	st.

Uponor Minitec koppeling verlopend Q&E				
 1020518	20xMinitec9,9	150	5	st.

Uponor Q&E koppeling PPSU				
 1008932	20-20	80	5	st.

Uponor Q&E knie 90° PPSU				
 1008680	20-20	40	5	st.

Uponor Q&E zekeringsring white				
 1057454	20	520	20	st.

Uponor Renovis

art.nr.	omschrijving	LE	VPE	eenheid	prijs/eenheid
---------	--------------	----	-----	---------	---------------

Uponor Uni Pipe PLUS wit S

 1060784	20x2,25 3m	51	3	m	
---	------------	----	---	---	--

Uponor Q&E T-stuk S-Press

 1063938	20-Q&E9,9-Press20	6	2	st.	
---	-------------------	---	---	-----	--

Uponor Q&E overgang S-Press

 1063939	20-Q&E9,9	12	2	st.	
---	-----------	----	---	-----	--

Uponor Vario aanvoer fijninregelafsluiter

 1005107	½" - G¾	50	1	st.	
---	---------	----	---	-----	--

Uponor Vario retour fijninregelafsluiter

 1005108	½" - G¾	50	1	st.	
---	---------	----	---	-----	--

Uponor Vario PLUS thermische aandrijving NC

 1005605	230V MT30x1,5	10	1	st.	
---	---------------	----	---	-----	--

Uponor Base ruimtethermostaat T-23

 1058422	230V RAL9010	160	1	st.	
---	--------------	-----	---	-----	--

Uponor Minitec expansiegereedschap

 1006247	9,9x1,1	11	1	set	
---	---------	----	---	-----	--

Uponor Q&E expansiegereedschap met expansiekop M12

 OUT 1063112	6BAR 9,9/20	-	1	set	
	<small>OUT Artikel is uitlopend. Levering zolang de voorraad strekt.</small>				

Uponor Q&E RS expansiegereedschap met expansiekop M12

 1119375	6bar 9,9RS/20	-	1	set	
---	---------------	---	---	-----	--

Uponor Multi Leiding geleidingsbocht

 NEW 1135490	10-12	360	60	st.	
NEW 1135492	20-22	140	35	st.	

Uponor Comfort E

art.nr.	omschrijving	LE	VPE	eenheid	prijs/eenheid
---------	--------------	----	-----	---------	---------------

Uponor Comfort E kabelmat set T-87IF

 1088668	160-1	50	1	set	
1088669	160-1,5	50	1	set	
1088670	160-2	50	1	set	
1088671	160-2,5	50	1	set	
1088672	160-3	50	1	set	
1088673	160-4	35	1	set	
1088674	160-5	35	1	set	
1088675	160-6	35	1	set	
1088676	160-7	20	1	set	
1088677	160-8	20	1	set	
1088678	160-10	20	1	set	
1088679	160-12	20	1	set	

Uponor Comfort E kabelmat

 1088656	160-1	50	1	set	
1088657	160-1,5	50	1	set	
1088658	160-2	50	1	set	
1088659	160-2,5	50	1	set	
1088660	160-3	50	1	set	
1088661	160-4	35	1	set	
1088662	160-5	35	1	set	
1088663	160-6	35	1	set	
1088664	160-7	20	1	set	
1088665	160-8	20	1	set	
1088666	160-10	20	1	set	
1088667	160-12	20	1	set	

Uponor Comfort E ruimtethermostaat set T-85

 1088705	230V	-	1	set	
---	------	---	---	-----	--

Uponor Comfort E ruimtetherm. digi. pro. flush Set T-86

 1088819	230V	-	1	set	
---	------	---	---	-----	--

Uponor Comfort E ruimtetherm. digi. pro. flush Set T-87IF

 1088706	230V	-	1	set	
---	------	---	---	-----	--

Uponor Comfort E vloersensor T-85, T-87

 1090944		100	1	st.	
---	--	-----	---	-----	--

Uponor Siccus wall

art.nr.	omschrijving	LE	VPE	eenheid
---------	--------------	----	-----	---------

Uponor Siccus 14 montageplaat

	1005485 EPS 150kPa 14mm 1197x1050x25mm	100	12,5	m ²
---	--	-----	------	----------------

Uponor Siccus 14 warmtegeleidingslamel

	1005486 14mm 1180x120x0,45mm	768	48	st.
---	--	-----	----	-----

Uponor Comfort Pipe PLUS leiding

	1062883 14x2,0 120m	1320	120	m
	1062884 14x2,0 240m	1680	240	m
	1062885 14x2,0 960m	1920	960	m

Uponor Vario klemringschroefkoppeling PEX

	1065283 14x2,0-G¾"FT Euro	25	1	st.
---	----------------------------------	----	---	-----

Uponor Fit klemovergangspuntstuk PEX

	1065294 14x2,0-R½"MT	25	1	st.
---	-----------------------------	----	---	-----

Uponor Fit klemovergangsschroefbus PEX

	1065295 14x2,0-Rp½"FT	25	1	st.
---	------------------------------	----	---	-----

Uponor Q&E koppeling met ringen DR

	1058659 14-14	100	10	st.
---	----------------------	-----	----	-----

Uponor Q&E ring met stop-edge natural, eval

	1058428 14	900	20	st.
---	-------------------	-----	----	-----

Uponor Smart perskoppeling

	1089646 14x2,0-14x2,0	80	20	st.
---	------------------------------	----	----	-----

Let op: pers met Uponor S-Press persbekken UPP1 voor Uponor MLC perskoppelingen of mini persbekken KSP0

art.nr.	omschrijving	LE	VPE	eenheid
---------	--------------	----	-----	---------

Uponor MLCP RED leiding

	1096010 14x1,6 240m	3120	240	m
	1096011 14x1,6 480m	3360	480	m

Uponor Vario klemkoppeling MLCP RED

	1000117 14x1,6-¾"Euro	80	20	st.
---	------------------------------	----	----	-----

Uponor MLCP RED perskoppeling

	1048272 14x1,6-14x1,6	80	20	st.
---	------------------------------	----	----	-----

Uponor Siccus 14 polystyreensnijder

	1006290 14mm 230V	20	1	st.
---	--------------------------	----	---	-----

Uponor Thermatop

art.nr.	omschrijving	LE	VPE	eenheid	prijs/eenheid
Uponor Thermatop M					
 1090933	950x277mm	200	10	st.	
1090934	1350X277mm	200	10	st.	
1090935	1750X277mm	200	10	st.	
1090936	2150X277mm	200	10	st.	
1090937	2550x277mm	200	10	st.	

art.nr.	omschrijving	LE	VPE	eenheid
---------	--------------	----	-----	---------

Uponor Uni-X schroefkoppeling MLC

 1058090	16-3/4"FT Euro	25	1	st.
--	----------------	----	---	-----

Uponor S-Press PLUS koppeling

 1070547	16-16	80	10	st.
--	-------	----	----	-----

Uponor S-Press PLUS koppeling PPSU

 1039933	16-16	80	10	st.
--	-------	----	----	-----



Uponor Multi

art.nr.	omschrijving	LE	VPE	eenheid
---------	--------------	----	-----	---------

Uponor Multi leidingbinder PA

 1005372	300mm	5000	100	st.
--	-------	------	-----	-----

Uponor Multi leidingbinder PA

 1086531	200mm	10000	100	st.
--	-------	-------	-----	-----

Uponor Multi montageprofiel

 1005358	20mm c/c50mm 3m	30	3	m
--	-----------------	----	---	---

Uponor Multi folie PE100 PE

 1005051	0,1mm 75x2m	6900	150	m ²
--	-------------	------	-----	----------------

Uponor Multi folie PE200 PE

 1005049	0,2mm 60x1,25m	3375	75	m ²
--	----------------	------	----	----------------

LET OP: verkoop per verpakkingseenheid van 1 rol (75 m²) = € 86,25

Uponor Multi rasterfolie

 OUT 1000015	0,25mm 100x1,03m	2472	103	m ²
--	---------------------	------	-----	----------------

OUT Artikel is uitlopend.
Levering zolang de voorraad strekt.

Uponor Multi folienagel

 1000016	l=25mm	5000	100	st.
--	--------	------	-----	-----

Uponor Multi randisolatie zelfklevend PE

 1013117	40m 100x10mm	-	240	m
1000080	150x10mm	-	200	m

art.nr.	omschrijving	LE	VPE	eenheid
---------	--------------	----	-----	---------

Uponor Multi randisolatie met foliestrook

 1000079	150x8mm	-	200	m
--	---------	---	-----	---

Uponor Multi dilatatieprofiel

 1090229	1800x100x10mm	720	18	m
--	---------------	-----	----	---

Uponor Multi beschermingsmantel

 1000082	20mm 300x5mm	10800	30	st.
--	--------------	-------	----	-----

Uponor Multi cementcomponent VD 450

 1000084	20L	480	20	l
--	-----	-----	----	---

LET OP: het cementcomponent dient tegen vorst en UV-straling beschermd te worden. Dit product is uitgesloten van retourname door Uponor.

Uponor Multi cementcomponent, snel droog VD 550 N

 1000085	25L	600	25	l
--	-----	-----	----	---

LET OP: het cementcomponent dient tegen vorst en UV-straling beschermd te worden. Dit product is uitgesloten van retourname door Uponor.

Uponor Multi markeringsset

 1000083	100mm	-	10	st.
--	-------	---	----	-----

Uponor Multi gebonden gietvloer

 1000052	100l	2500	100	l
--	------	------	-----	---

LET OP: verkoop per verpakkingseenheid

Uponor Multi antivriesmiddel

 1005066	≥ -30 °C 20 l	480	20	l
--	---------------	-----	----	---

Verdeel- en stijgleidingen 25-75 mm

art.nr.	omschrijving	LE	VPE	eenheid	prijs/eenheid
 1060785	25x2,5 3m	30	3	m	
1060786	32x3,0 3m	21	3	m	

Uponor MLC leiding wit S

 1013448	40x4,0 3m	12	3	m	
1021980	50x4,5 3m	12	3	m	
1021981	63x6,0 3m	9	3	m	
1013453	75x7,5 5m	255	5	m	

Uponor S-Press PLUS koppeling PPSU

 1039935	25-25	80	10	st.	
1039936	32-32	80	10	st.	

Uponor S-Press composiet koppeling PPSU

 1046401	40-40	960	5	st.	
1046402	50-50	576	3	st.	
1032881	63-63	384	1	st.	
1032882	75-75	384	1	st.	

Uponor S-Press PLUS koppeling verlopend PPSU

 1039940	32-25	80	10	st.	
--	-------	----	----	-----	--

Uponor S-Press koppeling verlopend PPSU

 1039941	40-25	960	5	st.	
1039942	40-32	960	5	st.	
1039943	50-32	1152	3	st.	

Uponor S-Press composiet koppeling verlopend PPSU

 1046406	50-40	576	3	st.	
1032883	63-40	384	1	st.	
1032884	63-50	384	1	st.	
1032885	75-50	384	1	st.	
1032886	75-63	384	1	st.	

Uponor S-Press PLUS knie 90° PPSU

 1039931	25-25	80	10	st.	
1039932	32-32	20	5	st.	

Uponor S-Press composiet knie 90° PPSU

 1046386	40-40	960	5	st.	
1046387	50-50	576	3	st.	
1032877	63-63	210	1	st.	
1032878	75-75	210	1	st.	

Uponor S-Press composiet knie 45° PPSU

 1046388	40-40	960	5	st.	
1046389	50-50	576	3	st.	
1032879	63-63	192	1	st.	
1032880	75-75	192	1	st.	

art.nr.	omschrijving	LE	VPE	eenheid	prijs/eenheid
 1039946	25-25-25	20	5	st.	
1039947	32-32-32	20	5	st.	

Uponor S-Press PLUS T-stuk PPSU

Uponor S-Press composiet T-stuk PPSU

 1046390	40-40-40	720	5	st.	
1046391	50-50-50	288	3	st.	
1032887	63-63-63	150	1	st.	
1032888	75-75-75	150	1	st.	

Uponor S-Press PLUS T-stuk binnendraad

 1070598	25-Rp $\frac{1}{2}$ "FT-25	20	5	st.	
1070600	32-Rp $\frac{1}{2}$ "FT-32	20	5	st.	

Uponor S-Press T-stuk binnendraad

 1046922	40-Rp $\frac{1}{2}$ "FT-40	500	5	st.	
1046929	50-Rp1"FT-50	240	3	st.	

Uponor S-Press PLUS puntstuk

 1070507	25-R $\frac{3}{4}$ "MT	80	10	st.	
1070508	25-R1"MT	40	5	st.	
1070509	32-R1"MT	40	5	st.	
1070510	32-R1 $\frac{1}{4}$ "MT	20	5	st.	

Uponor S-Press puntstuk

 1046901	40-R1 $\frac{1}{4}$ "MT	960	5	st.	
1046902	40-R1 $\frac{1}{2}$ "MT	960	5	st.	
1046905	50-R1 $\frac{1}{2}$ "MT	1152	3	st.	
1046906	50-R2"MT	576	3	st.	
1032895	63-R2"MT	336	1	st.	
1032896	75-R2 $\frac{1}{2}$ "MT	336	1	st.	

Uponor S-Press PLUS schroefbus

 1070519	25-Rp $\frac{3}{4}$ "FT	40	5	st.	
1070520	25-Rp1"FT	40	5	st.	
1070521	32-Rp1"FT	40	5	st.	
1070522	32-Rp1 $\frac{1}{4}$ "FT	20	5	st.	

Uponor S-Press schroefbus

 1046903	40-Rp1 $\frac{1}{4}$ "FT	960	5	st.	
1046904	40-Rp1 $\frac{1}{2}$ "FT	960	5	st.	
1046907	50-Rp1 $\frac{1}{2}$ "FT	1152	3	st.	

Uponor stelaandrijvingen en -adapters

Thermische aandrijving		Geschikt voor verdeler			
Uponor Vario PLUS thermische aandrijving PRO MT 30x1,5 		Uponor Vario PLUS 	Uponor Magna industriële verwarmingsverdeler 	Uponor Vario Regulierventiel 	Uponor Vario RL-ventiel 
Omschrijving	art.nr.				
24 V	1000138				
230 V	1005605				
Uponor Vario S thermische aandrijving 1 W NC FT 30x1,5 		Vario M met debietmeter FM 			
Omschrijving	art.nr.				
24 V	1087778				
230 V	1087763				
Uponor Vario thermische aandrijving S FT 30x1,5 		Vario S Roestvrijstalen verdeler ST FM en LS 	Vario S Roestvrijstalen verdeler ST LS en FM (t/m 2018) 	Vervangonderdeel Chronatherm	
Omschrijving	art.nr.				
24 V	1020262				
230 V	1020261				
Uponor Vario B thermische aandrijving PRO FT 28x1,5 		Vervangonderdeel Uponor Fluvia T 		Vervangonderdeel Unipipe	Vervangonderdeel 28x1.5
Omschrijving	art.nr.				
24 V	1007249				
230 V	1022244				
Uponor Vario PLUS Adapter VA 02 30 x 1,5 AG 		Vervangonderdelen Velta Kompakt en Velta Euro-Verdeler 			
Omschrijving	art.nr.				
24 V	1090262				
230 V	1090263				
Uponor Vario B Adapter VA 32 28 x 1,5 IG 		Vervangonderdeel Polytherm zonder DF 	Vervangonderdeel Polytherm DF 		
Omschrijving	art.nr.				
24 V	1090264				
230 V	1090265				

Uponor Vario PLUS

art.nr.	omschrijving	LE	VPE	eenheid	prijs/eenheid
---------	--------------	----	-----	---------	---------------

Uponor Vario PLUS verdeler met ventiel

 1042420	LS 1X ¾ Euro	10	1	set	
1030580	LS 3X ¾ Euro	290	1	set	
1030581	LS 4X ¾ Euro	225	1	set	
1030582	LS 6X ¾ Euro	155	1	set	

Uponor Vario PLUS verdeler m.debietmeter

 1042471	FM 1X ¾ Euro	10	1	set	
1030583	FM 3X ¾ Euro	174	1	set	
1030584	FM 4X ¾ Euro	135	1	set	
1030585	FM 6X ¾ Euro	93	1	set	

Uponor Vario PLUS verdeler set

 1009209	K1	248	1	st.	
---	----	-----	---	-----	--

Uponor Vario PLUS thermische aandrijving NC

 1000138	24V MT30x1,5	10	1	st.	
1005605	230V MT30x1,5	10	1	st.	

Uponor Vario drukverschilregelaar Compact

 NEW 1137437	G1 - G1	125	1	Set	
--	---------	-----	---	-----	--

Uponor Vario Inregelventiel G1-Rp1

 NEW 1137413		10	1	Set	
--	--	----	---	-----	--

Uponor Vario PLUS elektrothermische aandrijving 100kOhm

 1005544	24V NC MT30x1,5 0-10V DC	100	1	st.	
---	-----------------------------	-----	---	-----	--

Uponor Vario klemringschroefkoppeling PEX

 1065283	14x2,0-G¾"FT Euro	25	1	st.	
1065284	16x1,8/2,0-G¾"FT Euro	25	1	st.	
1065286	17x2,0-G¾"FT Euro	25	1	st.	
1065290	20x1,9/2,0-G¾"FT Euro	25	1	st.	

Uponor Vario PLUS aansluitset haaks

 1032702	122/42	5	1	set	
---	--------	---	---	-----	--

art.nr.	omschrijving	LE	VPE	eenheid
---------	--------------	----	-----	---------

Uponor Vario PLUS aansluitset

 1005227		10	1	set
---	--	----	---	-----

Uponor Vario PLUS tule vulslang

 1009214	G¾ x ½	10	1	st.
---	--------	----	---	-----

Uponor Vario PLUS afstandsringset

 1009215		10	1	st.
---	--	----	---	-----

Uponor Vario PLUS isolatieset

 1063207		-	1	set
---	--	---	---	-----

Uponor Vario benamingssticker

 1005063	47x10mm	-	1	set
---	---------	---	---	-----

Uponor Vario PLUS klik-therm. 0-60 °C

 1034524	D=40mm	20	1	set
--	--------	----	---	-----

Uponor Vario PLUS debietmeter

 1009217	4 l/min	20	1	st.
---	---------	----	---	-----

Uponor Vario PLUS aanvoerventiel-insert scale 1-5

 1034523		-	20	st.
---	--	---	----	-----

Uponor Vario PLUS terugslagklep insert

 1005250		10	1	st.
---	--	----	---	-----

Uponor Vario retourklep insert

 1005099		10	1	st.
---	--	----	---	-----

Uponor Vario stromingsventiel handwiel, wit

 1005101		-	1	st.
---	--	---	---	-----

Uponor Vario Handwiel met instelindicatiering COMP

 1005104		100	10	st.
---	--	-----	----	-----

Uponor Vario flow valve insert

 1005098		-	1	st.
---	--	---	---	-----

Uponor Vario M

art.nr.	omschrijving	LE	VPE	eenheid	prijs/eenheid
---------	--------------	----	-----	---------	---------------

Uponor Vario M verdeler met debietmeter FM

	1085944 2X G $\frac{3}{4}$ Euro	80	1	st.	
	1085945 3X G $\frac{3}{4}$ Euro	80	1	st.	
	1085946 4X G $\frac{3}{4}$ Euro	80	1	st.	
	1085947 5X G $\frac{3}{4}$ Euro	80	1	st.	
	1085948 6X G $\frac{3}{4}$ Euro	80	1	st.	
	1085949 7X G $\frac{3}{4}$ Euro	80	1	st.	
	1085950 8X G $\frac{3}{4}$ Euro	80	1	st.	
	1085951 9X G $\frac{3}{4}$ Euro	80	1	st.	
	1085952 10X G $\frac{3}{4}$ Euro	80	1	st.	
	1086250 11X G $\frac{3}{4}$ Euro	108	1	st.	
	1086251 12X G $\frac{3}{4}$ Euro	108	1	st.	
	1087129 13X G $\frac{3}{4}$ Euro	30	1	st.	
	1087130 14X G $\frac{3}{4}$ Euro	30	1	st.	
	1087131 15X G $\frac{3}{4}$ Euro	30	1	st.	

Uponor Vario thermische aandrijving S

	1087763 230V FT 30x1,5	100	1	Set	
	1087778 24V FT 30x1,5	100	1	Set	

art.nr.	omschrijving	LE	VPE	eenheid	prijs/eenheid
---------	--------------	----	-----	---------	---------------

Uponor Vario Drukverschilregelaar Compact

	NEW 1137437 G1 - G1	125	1	Set	
---	-----------------------------------	-----	---	-----	--

Uponor Vario Regulierventil G1-Rp1

	NEW 1137413	10	1	Set	
---	---------------------------	----	---	-----	--

Uponor Vario M Spruitstuk - Debietmeter

	NEW 1121531 0-5l/min	10	1	st.	
---	------------------------------------	----	---	-----	--

Uponor Vario M houder

	1087531	-	1	set	
---	----------------	---	---	-----	--

Uponor Vario M Vul- en aftapkraan

	1120810	10	1	st.	
---	----------------	----	---	-----	--

Uponor Vario benamingssticker

	1005063 47x10mm	-	1	set	
---	------------------------	---	---	-----	--

Uponor Vario M retourventiel

	1085957	-	1	st.	
---	----------------	---	---	-----	--

Uponor Vario M thermometer

	1085958	-	1	Set	
---	----------------	---	---	-----	--

Uponor Vario M borgbeugel set

	1085959 3x2	-	1	Set	
---	--------------------	---	---	-----	--

Uponor Vario S

art.nr.	omschrijving	LE	VPE	een- een- heid	prijs/ prijs/ eenheid
---------	--------------	----	-----	----------------------	-----------------------------

Uponor Vario S verdeler FM

	1086538 2X $\frac{3}{4}$ Euro	108	1	st.	
	1086539 3x $\frac{3}{4}$ Euro	108	1	st.	
	1086540 4x $\frac{3}{4}$ Euro	108	1	st.	
	1086541 5x $\frac{3}{4}$ Euro	108	1	st.	
	1086542 6x $\frac{3}{4}$ Euro	72	1	st.	
	1086543 7X $\frac{3}{4}$ Euro	72	1	st.	
	1086544 8x $\frac{3}{4}$ Euro	72	1	st.	
	1086545 9x $\frac{3}{4}$ Euro	72	1	st.	
	1086546 10x $\frac{3}{4}$ Euro	48	1	st.	
	1086547 11x $\frac{3}{4}$ Euro	48	1	st.	
	1086548 12x $\frac{3}{4}$ Euro	48	1	st.	
	1088864 13x $\frac{3}{4}$ Euro	48	1	st.	
	1088865 14X $\frac{3}{4}$ Euro	36	1	st.	
	1088866 15x $\frac{3}{4}$ Euro	36	1	st.	
	1088867 16x $\frac{3}{4}$ Euro	36	1	st.	

Uponor Vario S verdeler LS

	1088045 2X $\frac{3}{4}$ Euro	108	1	st.	
	1088046 3X $\frac{3}{4}$ Euro	108	1	st.	
	1088047 4X $\frac{3}{4}$ Euro	108	1	st.	
	1088048 5X $\frac{3}{4}$ Euro	108	1	st.	
	1088049 6X $\frac{3}{4}$ Euro	72	1	st.	
	1088050 7X $\frac{3}{4}$ Euro	72	1	st.	
	1088051 8X $\frac{3}{4}$ Euro	72	1	st.	
	1088052 9X $\frac{3}{4}$ Euro	72	1	st.	
	1088053 10X $\frac{3}{4}$ Euro	48	1	st.	
	1088054 11X $\frac{3}{4}$ Euro	48	1	st.	
	1088055 12x $\frac{3}{4}$ Euro	48	1	st.	
	1088868 13x $\frac{3}{4}$ Euro	48	1	st.	
	1088869 14x $\frac{3}{4}$ Euro	36	1	st.	
	1088870 15X $\frac{3}{4}$ Euro	36	1	st.	
	1088871 16X $\frac{3}{4}$ Euro	36	1	st.	

Uponor Vario thermische aandrijving NL NC

	1020261 230V FT30X1,5	100	1	st.	
	1020262 24V FT30X1,5	100	1	st.	

art.nr.	omschrijving	LE	VPE	een- een- heid	prijs/ prijs/ eenheid
---------	--------------	----	-----	----------------------	-----------------------------

Uponor Vario benamingssticker

	1005063 47x10mm	-	1	set	
---	------------------------	---	---	-----	--

Uponor Vario Drukverschilregelaar Compact

	NEW 1137437 G1 - G1	125	1	Set	
---	-----------------------------------	-----	---	-----	--

Uponor Vario Regulierventil G1-Rp1

	NEW 1137413	10	1	Set	
---	---------------------------	----	---	-----	--

Uponor Vario kogelkraan

	1059132 NP G1-G1	10	1	set	
---	-------------------------	----	---	-----	--

Uponor Vario kogelkraan

	1086558 $\frac{3}{4}$ -G1	10	1	set	
--	----------------------------------	----	---	-----	--

Uponor Vario kogelkraan haaks

	1086559 Rp $\frac{3}{4}$ " - G1"	-	1	set	
	1090732 G1-Rp1	260	1	set	

Uponor Vario aansluitstuk

	1058573 G1-G1A	30	1	st.	
---	-----------------------	----	---	-----	--

Uponor Vario aanvoer fijnregelafsluiter

	1005107 $\frac{1}{2}$ " - G $\frac{3}{4}$	50	1	st.	
---	--	----	---	-----	--

Uponor Vario retour fijnregelafsluiter

	1005108 $\frac{1}{2}$ " - G $\frac{3}{4}$	50	1	st.	
---	--	----	---	-----	--

Uponor Vario S

art.nr.	omschrijving	LE	VPE	eenheid
---------	--------------	----	-----	---------

Uponor Vario WM aansluiting horizontaal

 1090730	G $\frac{3}{4}$ " 110mm	250	1	set
1090728	G1" 130mm	-	1	set

Uponor Vario WM aansluiting verticaal

 1090731	G $\frac{3}{4}$ " 110mm	250	1	set
1090729	G1" 130mm	250	1	set

Uponor Vario koppeling voor WM-sensor

 1007177	M10-5mm	-	1	st.
--	---------	---	---	-----

Uponor Vario aansluitknie

 1000110	1"FT-1"MT	50	10	st.
--	-----------	----	----	-----

Uponor Aqua PLUS verdelerkap met vlakdichting

 1001337	$\frac{3}{4}$ "FT	250	10	st.
--	-------------------	-----	----	-----

art.nr.	omschrijving	LE	VPE	eenheid
---------	--------------	----	-----	---------

Uponor Vario S thermometer

 1086537		10	1	set
--	--	----	---	-----

Uponor Vario S verd. aanvoerventiel LS

 1088056		-	10	st.
--	--	---	----	-----

Uponor Vario S spuitstuk debietmeter

 1087608		-	10	st.
--	--	---	----	-----

Afmetingen verdelerkast

art.nr. omschrijving LE VPE een-
montageplaats en inbouwmaten

heid prijs/
eenheid

art.nr. omschrijving

LE VPE een-
heid

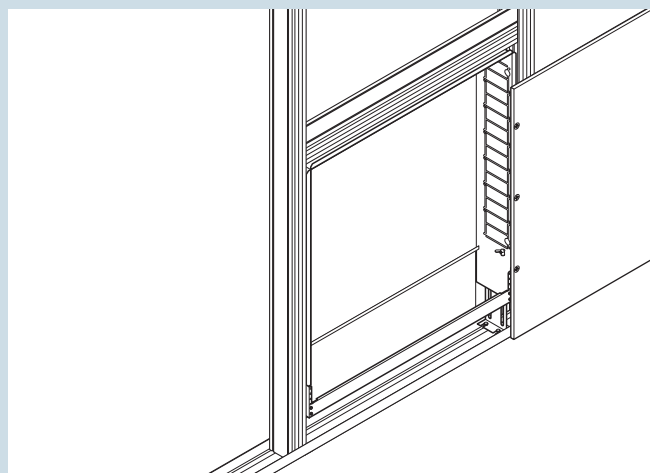
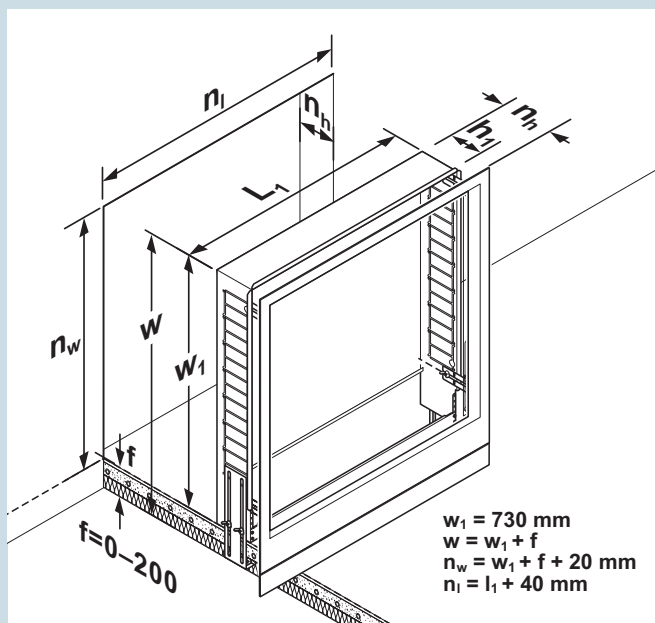

Verwarming
en koeling

met Uponor Vario PLUS verdeler	Va-riant	Aansluitsituatie	verdelerkast breedte l_1 (mm)					h_1 (mm)	n_h min. (mm)	
			550	700	850	1000	1150			1300
geschikt voor aantal groepen										
	1	Verticaal (zonder Vario WMZ-aansluitset)	2-4	5-7	8-10	11-13	14-15	-	80	80*
	2	Verticaal (met Vario WMZ-aansluitset)	2-4	5-7	8-10	11-13	14-15	-	80	95
	3	Zijdelings (zonder Vario WMZ-aansluitset)	2-5	6-8	9-11	12-14	15	-	80	80*
	4	Zijdelings (met Vario WMZ-aansluitset)	-	2-3	4-6	7-9	10-12	13-15	80	95
	5	Met pompgroep Push 23 B	2-3	4-6	7-9	10-12	13-15	-	110	110*
	6	Met pompgroep MPG 10 / Push 23 A	-	2-4	5-7	8-10	11-13	14-15	110	110*
	7	Zijdelings met Viva drukverschilregelaar en WMZ	-	2	3-5	6-8	9-11	12-14	80	80*
	8	Verticaal met Viva drukverschilregelaar en WMZ	-	2-3	4-6	7-9	10-12	13-15	80	95

met Uponor Vario M verdeler	Va-riant	Aansluitsituatie	verdelerkast breedte l_1 (mm)					h_1 (mm)	n_h min. (mm)	
			550	700	850	1000	1150			1300
geschikt voor aantal groepen										
	1	Verticaal (zonder Vario WMZ-aansluitset)	2-5	6-8	9-10	11-13	14-15	-	80	80*
	2	Verticaal (met Vario WMZ-aansluitset)	2-5	6-8	9-10	11-13	14-15	-	80	95
	3	Zijdelings (zonder Vario WMZ-aansluitset)	2-6	7-9	10-11	12-14	15	-	80	80*
	4	Zijdelings (met Vario WMZ-aansluitset)	-	2-4	5-7	8-10	11-12	13-15	80	95
	5	Met pompgroep Push 23 B	2-4	5-7	8-10	11-12	13-15	-	110	110*
	6	Met pompgroep MPG 10 / Push 23 A	-	2-4	5-7	8-10	11-13	14-15	110	110*
	7	Zijdelings met Viva drukverschilregelaar en WMZ	-	2-3	4-6	7-9	10-11	12-14	80	80*
	8	Verticaal met Viva drukverschilregelaar en WMZ	-	2-4	5-7	8-10	11-12	13-15	80	95

met Uponor Vario S verdeler	Va-riant	Aansluitsituatie	verdelerkast breedte l_1 (mm)					h_1 (mm)	n_h min. (mm)	
			550	700	850	1000	1150			1300
geschikt voor aantal groepen										
	1	Verticaal (zonder Vario WMZ-aansluitset)	2-5	6-8	9-11	12-14	15-16	-	80	80*
	2	Verticaal (met Vario WMZ-aansluitset)	2-5	6-8	9-11	12-14	15-16	-	80	95
	3	Zijdelings (zonder Vario WMZ-aansluitset)	2-6	7-9	10-12	13-15	16	-	80	80*
	4	Zijdelings (met Vario WMZ-aansluitset)	-	2-4	5-7	8-10	11-13	14-16	80	95
	5	Met pompgroep Push 23 B	2-4	5-7	8-10	11-13	14-16	-	110	110*
	6	Met pompgroep MPG 10 / Push 23 A	-	2-4	5-7	8-10	11-13	14-16	110	110*
	7	Zijdelings met Viva drukverschilregelaar en WMZ	-	2-3	4-6	7-9	10-12	13-15	80	80*
	8	Verticaal met Viva drukverschilregelaar en WMZ	-	2-4	5-7	8-10	11-13	14-16	80	95

WMZ = Vario WMZ-aansluitset

* plus 10 mm bij gebruik van een kunststof deur

Uponor Vario

art.nr.	omschrijving	LE	VPE	eenheid
---------	--------------	----	-----	---------

Uponor Vario verdelerkast IW

 1093491	550x730x110mm	18	1	st.
1093492	700x730x110mm	16	1	st.
1093493	850x730x110mm	13	1	st.
1093494	1000x730x110mm	12	1	st.
1093495	1150x730x110mm	8	1	st.
1093496	1300x730x110mm	8	1	st.

Uponor Vario verdelerkast IW

 1093497	550x730x80mm	28	1	st.
1093498	700x730x80mm	25	1	st.
1093499	850x730x80mm	19	1	st.
1093500	1000x730x80mm	18	1	st.
1093501	1150x730x80mm	12	1	st.
1093502	1300x730x80mm	12	1	st.

Uponor Vario verdelerkast omlijsting en deur IW S

 1093528	550x730mm	35	1	st.
1093541	700x730mm	30	1	st.
1093542	850x730mm	25	1	st.
1093543	1000x730mm	20	1	st.
1093544	1150x730mm	15	1	st.
1093546	1300x730mm	15	1	st.

Uponor Vario verdelerkast omlijsting en deur IW P

 1093547	550x730mm	35	1	st.
1093548	700x730mm	30	1	st.
1093549	850x730mm	25	1	st.
1093550	1000x730mm	20	1	st.
1093551	1150x730mm	15	1	st.
1093552	1300x730mm	15	1	st.

Uponor Vario cilinderset met twee sleutels

 1093554		200	1	st.
--	--	-----	---	-----

Uponor Vario rail

 1093555		200	1	st.
--	--	-----	---	-----

art.nr.	omschrijving	LE	VPE	eenheid
---------	--------------	----	-----	---------

Uponor Vario bevestigingsmateriaal

 OUT 1093522	(5pcs)	200	1	st.
---	--------	-----	---	-----

OUT Artikel is uitlopend.
Levering zolang de voorraad strekt.

Uponor Vario Verteilerkast OW

 NEW 1136215	450x730x135	25	1	st.
NEW 1136216	600x730x135	17	1	st.
NEW 1136217	750x730x135	15	1	st.
NEW 1136218	900x730x135	12	1	st.
NEW 1136219	1050x730x135	11	1	st.
NEW 1136220	1200x730x135	7	1	st.
NEW 1136221	1350x730x135	7	1	st.
NEW 1136222	1550x730x135	7	1	st.

Uponor Vario Achterpaneel kast OW

 NEW 1136223	450x730	5	1	st.
NEW 1136224	600x730	5	1	st.
NEW 1136225	750x730	5	1	st.
NEW 1136226	900x730	5	1	st.
NEW 1136227	1050x730	5	1	st.
NEW 1136228	1200x730	5	1	st.
NEW 1136229	1350x730	5	1	st.
NEW 1136230	1550x730	5	1	st.

Uponor Magna verdelerkast opbouw

 1060553	1010x835x200mm	-	1	st.
1060554	1910x835x200mm	-	1	st.
1060555	2310x835x200mm	-	1	st.

Uponor Vario verdelerkast opbouw AP

 OUT 1045478	600x156mm	11	1	st.
OUT 1045479	800x156mm	10	1	st.
OUT 1045480	1000x156mm	9	1	st.
OUT 1045481	1350x156mm	8	1	st.

Uponor Vario achterwand verdelerkast AP

 OUT 1045482	580mm	15	1	st.
OUT 1045483	780mm	30	1	st.
OUT 1045484	980mm	20	1	st.
OUT 1045485	1330mm	-	1	st.

OUT Artikel is uitlopend.
Levering zolang de voorraad strekt.

Uponor Smatrix

Uponor temperatuurregelingen voor individuele ruimten oppervlakteverwarming/-koeling in de woningbouw

verwarmen en koelen		alleen verwarmen		
met automatische afstelling		met automatische afstelling	zonder automatische afstelling	
draadloos	bedraad	draadloos	bedraad	bedraad
Uponor Smatrix Wave PULSE	Uponor Smatrix Base PULSE	Uponor Smatrix Wave PULSE	Uponor Smatrix Base PULSE	Uponor Base met Flexiboard

Verwarming en koeling

De Uponor temperatuurregeling	... is een:
Uponor Smatrix Wave PULSE	per app aangestuurde draadloze temperatuurregeling voor individuele ruimten om te verwarmen en te koelen met vele functies, bijv. verbinding met Smart Home (<i>Amazon Alexa, Google Home</i>) en Cloud
Uponor Smatrix Wave	draadloze ruimtetemperatuurregeling voor oppervlakteverwarming en -koeling
Uponor Smatrix Base PULSE	per app aangestuurde bedrade temperatuurregeling voor individuele ruimten om te verwarmen en te koelen met vele functies, bijv. verbinding met Smart Home (<i>Amazon Alexa, Google Home</i>) en Cloud
Uponor Smatrix Base PRO	bedrade temperatuurregeling voor individuele ruimten om te verwarmen en te koelen met een maximum van 16 regelmodules voor commerciële gebouwen en grote objecten
Uponor Base	conventionele bedrade 230 V temperatuurregeling voor individuele ruimten voor een gemakkelijkeruimtetemperatuurregeling
Uponor Space	gemakkelijk te bedienen ruimtetemperatuurregeling voor koelplafonds met dauwpuntbewaking
Uponor Smatrix Style	design-ruimtesensor met vochtigheidsbewaking voor Smatrix Wave/Base PULSE en Smatrix Base PRO temperatuurregeling voor individuele ruimten
Smatrix Move	weersafhankelijke aanvoertemperatuurregelaar om te verwarmen en te koelen
Smatrix Move PRO	weersafhankelijke meerzonen-aanvoertemperatuurregelaar voor commerciële gebouwen om te verwarmen of te verwarmen/koelen en met bijkomend sneeuw- en ijsvrijhouden

Overzicht van de functies van Smatrix Wave/Base

Uponor Smatrix Regelingstechniek	complete versie		zonder Cloud		alleen regelmodule	
	Smatrix Wave PULSE	Smatrix Base PULSE	Smatrix Wave PULSE	Smatrix Base PULSE	Smatrix Wave PULSE	Smatrix Base PULSE
Toegang op afstand	■	■				
Comfortinstelling	■	■				
Verlagingsprogramma's	■	■				
Updates per app	■	■				
Verbinding Alexa	■	■				
Schakelen op afstand van andere installatiecomponenten via relaismodule	■					
Plaatselijke toegang via WLAN	■	■	■	■		
Maximum-/minimumbe- grenzing van de voor- ingestelde temperatuur	■	■	■	■		
Aanmaken van een regelingsgroep met 4 regelmodules	■	■	■	■		
Uitgebreide omschakel- mogelijkheden verwarmen/koelen	■	■	■	■		
Centrale verlagingsmodus	■	■	■	■		
Automatische afstelling	■	■	■	■	■	■
Verwarmen en koelen	■	■	■	■	■	■
RF-schakelaarstrip		■		■		■
Regeling van verwarmingselementen	■	■	■	■	■	■

Uponor Smatrix Wave / Pulse

art.nr.	omschrijving	LE	VPE	eenheid	prijs/eenheid
---------	--------------	----	-----	---------	---------------

Uponor Smatrix Wave startset Pulse S

 1093284		3	1	set	
---	--	---	---	-----	--

Uponor Smatrix Wave startset Pulse L

 1093287		2	1	set	
---	--	---	---	-----	--

Uponor Smatrix Interface Pulse com R-208

 1093030		16	1	st.	
---	--	----	---	-----	--

Uponor Smatrix Wave regelmodule Pulse X-265 6X

 1093021		4	1	st.	
---	--	---	---	-----	--

Uponor Smatrix Wave slave module Pulse M-262 6X

 1093133		16	1	st.	
--	--	----	---	-----	--



Uponor Smatrix Wave antenne Pulse A-265

 1093028		16	1	st.	
---	--	----	---	-----	--

Uponor Smatrix Wave schakelmodule M-161

 1071673	2X	16	1	st.	
---	----	----	---	-----	--

Uponor Smatrix Wave ruimtethermostaat met luchtvochtigheidssensor Style T-169

 1087816	wit	180	1	st.	
 1087817	zwart	180	1	st.	

Uponor Smatrix Wave ruimtetemperatuursensor met luchtvochtigheidssensor Style T-161

 1087815		180	1	st.	
---	--	-----	---	-----	--

art.nr.	omschrijving	LE	VPE	eenheid	prijs/eenheid
---------	--------------	----	-----	---------	---------------

Uponor Smatrix Base Muur frame T-141

 1122237		20	1	st.	
---	--	----	---	-----	--

Uponor Smatrix Wave ruimtethermostaat prog.+RH T-168

 1086984	RAL9016	75	1	st.	
---	---------	----	---	-----	--

Uponor Smatrix Wave ruimtethermostaat digit. T-166

 1086982	RAL9016	75	1	st.	
---	---------	----	---	-----	--

Uponor Smatrix Wave ruimtethermostaat T-165 POD

 1086981	RAL9016	75	1	st.	
---	---------	----	---	-----	--

Uponor Smatrix Wave ruimtethermostaat BM T-163

 1086979	RAL9016	75	1	st.	
---	---------	----	---	-----	--

Uponor Smatrix Wave thermostaatknop T-162

 1071660		16	1	st.	
---	--	----	---	-----	--

Uponor Smatrix montageplaat T-X A-1XX

 1086986	RAL9016	250	1	st.	
---	---------	-----	---	-----	--

Uponor Smatrix vloer- en afstandsvouler S-1XX

 1071684		63	1	st.	
---	--	----	---	-----	--

Uponor Smatrix schakelmodule H/K M-1XX

 1083576	24V	84	1	st.	
---	-----	----	---	-----	--

Uponor Smatrix schakelmodule H/K M-1XX

 1083577	230V	16	1	st.	
---	------	----	---	-----	--

Uponor Smatrix thermische aandrijving Retrofit set A-XXX

 1083575	24V, NC, 1W	100	1	set	
---	-------------	-----	---	-----	--

Uponor Smatrix Base / Pulse

art.nr.	omschrijving	LE	VPE	eenheid
---------	--------------	----	-----	---------

Uponor Smatrix Base startset Pulse S

 1093280		3	1	set
---	--	---	---	-----

Uponor Smatrix Base startset Pulse L

 1093282		2	1	set
---	--	---	---	-----

Uponor Smatrix Interface Pulse com R-208

 1093030		16	1	st.
---	--	----	---	-----

Uponor Smatrix Base regelmodule Pulse X-245 BUS 6X

 1093017		4	1	st.
---	--	---	---	-----



Uponor Smatrix Base uitbreidingsmodule Pulse M-242 BUS 6X

 1093134		16	1	st.
--	--	----	---	-----

Uponor Smatrix Base ster-module Pulse M-243 BUS 6X

 1093135		16	1	st.
---	--	----	---	-----

Uponor Smatrix Base ruimtetemperatuur-vochtsensor Style T-149 Bus

 1087813 wit		180	1	st.
 1087814 zwart		180	1	st.

Uponor Smatrix Base PRO Vochtsensor ruimtetemperatuur Style T-141 Bus

 1087812 FLUSH		180	1	st.
---	--	-----	---	-----

Uponor Smatrix Base Muur frame T-141

 1122237		20	1	st.
---	--	----	---	-----

Uponor Smatrix Base ruimtethermostaat prog +RH T-148 Bus

 1086977 RAL9016		75	1	st.
---	--	----	---	-----

Uponor Smatrix Base ruimtethermostaat digit. T-146 Bus

 1086976 RAL9016		75	1	st.
---	--	----	---	-----

art.nr.	omschrijving	LE	VPE	eenheid
---------	--------------	----	-----	---------

Uponor Smatrix Base ruimtethermostaat T-145 Bus POD

 1086975 RAL9016		75	1	st.
---	--	----	---	-----

Uponor Smatrix Base ruimtethermostaat inbouw T-144 Bus

 1086973 RAL9016		60	1	st.
---	--	----	---	-----



Uponor Smatrix Base ruimtethermostaat BM T-143 Bus

 1086972 RAL9016		75	1	st.
---	--	----	---	-----

Uponor Smatrix vloer- en afstandsvouler S-1XX

 1071684		63	1	st.
---	--	----	---	-----

Uponor Smatrix Base opbouwmontageframe Style T-149 A-14X

 1087821 wit		90	1	st.
 1087822 zwart		90	1	st.

Uponor Smatrix montageplaat T-X A-1XX

 1086986 RAL9016		250	1	st.
---	--	-----	---	-----

Uponor Smatrix Base Buskabel A-145

 1071670 50m		2	1	st.
---	--	---	---	-----

Uponor Smatrix schakelmodule H/K M-1XX

 1083576 24V		84	1	st.
---	--	----	---	-----

Uponor Smatrix schakelmodule H/K M-1XX

 1083577 230V		16	1	st.
--	--	----	---	-----

Uponor Smatrix thermische aandrijving Retrofit set A-XXX

 1083575 24V, NC, 1W		100	1	set
---	--	-----	---	-----

Uponor Smatrix Base PRO

art.nr.	omschrijving	LE	VPE	eenheid	prijs/eenheid
---------	--------------	----	-----	---------	---------------

Uponor Smatrix Base PRO regelmodule X-147 Bus

 1087162	6X	4	1	st.	
---	----	---	---	-----	--

Uponor Smatrix Base uitbreidingsmodule M-140 Bus

 1071686	6X	16	1	st.	
---	----	----	---	-----	--

Uponor Smatrix Base ster-module M-141 Bus

 1071651	8X	16	1	st.	
---	----	----	---	-----	--

Uponor Smatrix Base PRO Bedieningsmodule I-147 Bus

 1087161		7	1	st.	
---	--	---	---	-----	--

art.nr.	omschrijving	LE	VPE	eenheid	prijs/eenheid
---------	--------------	----	-----	---------	---------------

Uponor Smatrix Base PRO Vochtsensor ruimtetemperatuur Style T-141 Bus

 1087812	FLUSH	180	1	st.	
---	-------	-----	---	-----	--

Uponor Smatrix Base Muur frame T-141

 1122237		20	1	st.	
---	--	----	---	-----	--

Uponor Smatrix Base PRO KNX Schnittst. R-147 KNX

 1087164		-	1	st.	
---	--	---	---	-----	--

Uponor Base

art.nr.	omschrijving	LE	VPE	eenheid	prijs/eenheid
---------	--------------	----	-----	---------	---------------

Uponor Base 6-kanaals regelmodule X-23

 1058426	6X 230V	200	1	st.	
--	---------	-----	---	-----	--

Uponor Base flexiboard X-24

 1088331	6X 230V	-	1	st.	
--	---------	---	---	-----	--

Uponor Base flexiboard met pomplogica X-25

 1089086	6X 230V	-	1	st.	
--	---------	---	---	-----	--

Uponor Base flexiboard X-26

 1089087	8X 230V	-	1	st.	
--	---------	---	---	-----	--

Uponor Base flexiboard met pomplogica X-27

 1089088	8X 230V	-	1	st.	
--	---------	---	---	-----	--

art.nr.	omschrijving	LE	VPE	eenheid	prijs/eenheid
---------	--------------	----	-----	---------	---------------

Uponor Base ruimtethermostaat T-23

 1058422	230V RAL9010	160	1	st.	
--	--------------	-----	---	-----	--

Uponor Base ruimtethermostaat UP T-24

 1058423	230V	-	1	st.	
--	------	---	---	-----	--

Uponor Base ruimtethermostaat V/K T-25

 1058424	230V	-	1	st.	
--	------	---	---	-----	--

Uponor Base ruimtethermostaat prog. T-26

 1058425	230V RAL9010	-	1	st.	
--	--------------	---	---	-----	--

Uponor Base afstandsvoeler

 1047459	230V	-	1	st.	
---	------	---	---	-----	--

Uponor Vario B thermische aandrijving NC

 1022244	230V FT28x1,5	10	1	st.	
--	---------------	----	---	-----	--

Uponor Vario thermische aandrijving NL NC

 1020261	230V FT30x1,5	100	1	st.	
--	---------------	-----	---	-----	--

Uponor Vario PLUS thermische aandrijving NC

 1005605	230V MT30x1,5	10	1	st.	
--	---------------	----	---	-----	--

Regeling van de aanvoertemperatuur

art.nr.	omschrijving	LE	VPE	een- heid	prijs/ eenheid
---------	--------------	----	-----	--------------	-------------------

Uponor Smatrix Move PRO

Uponor Smatrix Move PRO regelaar X-159

	1087155	10	1	st.
---	---------	----	---	-----

Uponor Smatrix Move PRO sneeuw- en ijsvrij houden S-152 + S-158

	1087158	-	1	set
	1087156	5	1	st.

Uponor Smatrix Move PRO ruimtesensor S-155

	1087159	10	1	st.
---	---------	----	---	-----

art.nr.	omschrijving	LE	VPE	een- heid
---------	--------------	----	-----	--------------

Uponor Smatrix Move PRO luchtvochtigheidssensor S-157

	1087160	75	1	st.
---	---------	----	---	-----

Uponor Smatrix Move PRO condensatieset S-159

	1087165	10	1	set
---	---------	----	---	-----

Regeling van de aanvoertemperatuur

art.nr.	omschrijving	LE	VPE	eenheid
---------	--------------	----	-----	---------

art.nr.	omschrijving	LE	VPE	eenheid
---------	--------------	----	-----	---------

Uponor Smatrix Move

Uponor Smatrix Move regelaar X-157 Wired



1071693		4	1	set
---------	--	---	---	-----

Uponor Smatrix schakelmodule H/K M-1XX



1083577	230V	16	1	st.
---------	------	----	---	-----

Uponor Smatrix Move aanvoer/retourvoeler S-152



1071661	3m	63	1	st.
---------	----	----	---	-----

Uponor Smatrix Move mengventiel motoraandrijving 230V



1002357		-	1	st.
---------	--	---	---	-----

Uponor Smatrix buitenvoeler S-1XX



1071671		45	1	st.
---------	--	----	---	-----

Regeling van de aanvoertemperatuur

art.nr.	omschrijving	LE	VPE	eenheid	prijs/eenheid
---------	--------------	----	-----	---------	---------------

Uponor Fluvia

Uponor Fluvia T regelaar Push-12-CH-X

	1085982	50	1	st.	
---	---------	----	---	-----	--

Uponor Fluvia T pompgroep Push-12 AC-G

	1095128	60	1	st.	
---	---------	----	---	-----	--

Uponor Fluvia schroef-Y-stuk

	1005675	2xG $\frac{3}{4}$ - $\frac{3}{4}$ "Euro	50	1	set
---	---------	---	----	---	-----

Uponor Vario vul- en aftapkraan

	1061802	$\frac{3}{4}$ " - $\frac{3}{4}$ "	10	1	set
---	---------	-----------------------------------	----	---	-----

Uponor Aqua PLUS verdelerkap met vlakdichting

	1001337	$\frac{3}{4}$ "FT	250	10	st.
---	---------	-------------------	-----	----	-----

Uponor Fluvia Move pompgroep Push-23-A-AC

	1085008		30	1	st.
---	---------	--	----	---	-----

Uponor Fluvia T pompgroep Push-23-B-W

	1078304		55	1	st.
---	---------	--	----	---	-----

Uponor Fluvia Move pompgroep MPG-10-A-W

	1078306		30	1	st.
---	---------	--	----	---	-----

Uponor Fluvia pompgroep MPG-10-B-W

	1078307		30	1	st.
---	---------	--	----	---	-----

art.nr.	omschrijving	LE	VPE	eenheid	
---------	--------------	----	-----	---------	--

Uponor Vario aansluitstuk

	1058573	G1-G1A	30	1	st.
---	---------	--------	----	---	-----

Uponor Fluvia maximaalthermostaat

	1005504	5-60	10	1	st.
---	---------	------	----	---	-----

Uponor Fluvia Move pompgroep PPG-30-A-W

	1084143		22	1	st.
---	---------	--	----	---	-----

Uponor Smatrix Move mengventiel motoraandrijving pro

	1002356	A-15X 24V 0-10 V	-	1	st.
---	---------	------------------	---	---	-----

Uponor Smatrix Move mengventiel motoraandrijving 230V

	1002357		-	1	st.
---	---------	--	---	---	-----

Verbindingstechniek, fittingen en gereedschappen voor Uponor Ecoflex leidingen

Type	Afmeting [mm]	Medium- buis	Isolatiemateriaal	Mantel- buis	Temperatuur / Druk	Lengte [m]	Artikelnr.	Certificering
 VIP Thermo Single	40 x 3,7/140	PE-Xa + EVOH	VIP + PEX-schuim	PE-HD	max. 95 °C / 6 bar	200	1095714	KOMO systeem- certificering CSTB systeem- certificering
	50 x 4,6/140					200	1095715	
	63 x 5,8/140					200	1095716	
	75 x 6,8/140					200	1095717	
	90 x 8,2/175					100	1095718	
	110 x 10,0/175					100	1095719	
	125 x 11,4/200					120	1095720	
 VIP Thermo Twin	2x25 x 2,3/140	PE-Xa + EVOH	VIP + PEX-schuim	PE-HD	max. 95 °C / 6 bar	200	1118580	KOMO systeem- certificering CSTB systeem- certificering
	2x32 x 2,9/140					200	1118581	
	2x40 x 3,7/175					200	1118582	
	2x50 x 4,6/175					200	1118583	
	2x63 x 5,8/200					100	1118584	
	2x75 x 6,8/250					100	1118585	
 Thermo Single optioneel met verwarmingkabel	25 x 2,3/140	PE-Xa + EVOH	PEX-schuim	PE-HD	max. 95 °C / 6 bar	200	1018109	- KOMO systeem- certificatie gebaseerd op Kiwa richtlijn BRL 5609 - CSTB systeemcertificatie - Verklaring volgens DIN EN 15632 door certificatie-instelling Kiwa N.V. - DIN CERTCO Warmte- verliescertificering - gecontroleerd volgens VDI 2055
	32 x 2,9/140					200	1018110	
	40 x 3,7/175					200	1018111	
	50 x 4,6/175					200	1018112	
	63 x 5,8/175					200	1018113	
	75 x 6,8/200					100	1018114	
	90 x 8,2/200					100	1018115	
	110 x 10,0/200					100	1018116	
 Thermo Twin	2x25 x 2,3/175	PE-Xa + EVOH	PEX-schuim	PE-HD	max. 95 °C / 6 bar	200	1018134	- KOMO systeem- certificatie gebaseerd op Kiwa richtlijn BRL 5609 - CSTB systeemcertificatie - Verklaring volgens DIN EN 15632 door certificatie-instelling Kiwa N.V. - DIN CERTCO Warmte- verliescertificering - gecontroleerd volgens VDI 2055
	2x32 x 2,9/175					200	1018135	
	2x40 x 3,7/175					200	1018136	
	2x50 x 4,6/200					100	1018137	
	2x63 x 5,8/200					100	1018138	
 Thermo Mini	25 x 2,3/68	PE-Xa + EVOH	PEX-schuim	PE-HD	max. 95 °C / 6 bar	200	1018132	CSTB systeem- certificering
	32 x 2,9/68					200	1018133	

Verbindingstechniek, fittingen en gereedschappen voor Uponor Ecoflex leidingen

Type	Afmeting [mm]	Medium- buis	Isolatie- materiaal	Mantel- buis	Temperatuur / Druk	Lengte [m]	Artikelnr.	Certificering	Toebehoren Rubberen eindkap
 VIP Aqua Single	40 x 5,5/140	PE-Xa	VIP + PEX- schuim	PE-HD	max. 95 °C / 10 bar	200	1119047	DVGW, ÖVGW	
	50 x 6,9/140					200	1119048		
	63 x 8,6/140					200	1119049		
 VIP Aqua Twin	25 x 3,5-20 x 2,8/140	PE-Xa	VIP + PEX- schuim	PE-HD	max. 95 °C / 10 bar	200	1119053	DVGW, ÖVGW	
	32 x 4,4-20 x 2,8/140					200	1119054		
	40 x 5,5-25 x 3,5/140					200	1119055		
	50 x 6,9-32 x 4,4/175					200	1119056		
 Aqua Single optioneel met verwarmingkabel	25 x 3,5/140	PE-Xa	PEX- schuim	PE-HD	max. 95 °C / 10 bar	200	1018117	DVGW, ÖVGW	
	32 x 4,4/140					200	1018118		
	40 x 5,5/175					200	1018119		
	50 x 6,9/175					200	1018120		
	63 x 8,6/175					200	1018121		
 Aqua Twin	25 x 3,5-25 x 3,5/175	PE-Xa	PEX- schuim	PE-HD	max. 95 °C / 10 bar	200	1018139	DVGW, ÖVGW	
	32 x 4,4-25 x 3,5/175					200	1018140		
	40 x 5,5-25 x 3,5/175					200	1018141		
	50 x 6,9-25 x 3,5/175					200	1018142		
 Quattro	2x25 x 2,3-2x25 x 3,5/175	PE-Xa + EVOH + PE-Xa	PEX- schuim	PE-HD	max. 95 °C / 6 / 10 bar	200	1018147	DVGW, ÖVGW	
	2x32 x 2,9-2x25 x 3,5/175					200	1018148		
	2x32 x 2,9-32 x 4,4-25 x 3,5/175					200	1018149		
 Supra	25 x 2,3/68	PE 100-RC zwart met blauwe laag	PEX- schuim	PE-HD	20 °C / 16 bar	200	1095722	DVGW	
	32 x 2,9/68					200	1095723		
	40 x 3,7/140					200	1095724		
	50 x 4,6/140					200	1095725		
	63 x 5,8/140					200	1095726		
	75 x 6,8/175					100	1095727		
	90 x 8,2/175					100	1095728		
	110 x 10,0/200					100	1095729		
 Supra PLUS kabel met anti-vrieskabel	25 x 2,3/68	PE 100-RC zwart met blauwe laag	PEX- schuim	PE-HD	20 °C / 16 bar	150	1095730	DVGW	
	32 x 2,9/68					150	1095731		
	40 x 3,7/140					150	1095734		
	50 x 4,6/140					150	1095736		
	63 x 5,8/140					150	1095737		
	75 x 6,8/175					150	1095738		
	90 x 8,2/200					100	1095739		
	110 x 10,0/200					100	1095740		

WARM DRINKWATER

VERWARMEN EN WARM
DRINKWATER

KOUD DRINKWATER EN KOELEN

KOUD DRINKWATER

Lokale warmtedistributie

art.nr.	omschrijving	LE	VPE	eenheid
---------	--------------	----	-----	---------

Uponor Ecoflex VIP Thermo

Uponor Ecoflex VIP Thermo Single

 1095714	40X3,7/140	-	200	m
1095715	50X4,6/140	-	200	m
1095716	63X5,8/140	-	200	m
1095717	75X6,8/140	-	200	m
1095718	90X8,2/175	-	150	m
1095719	110X10,0/175	-	150	m
1095720	125X11,4/200	-	120	m

Uponor Ecoflex VIP Thermo Twin

 1118580	2x25x2,3/140	-	200	m
1118581	2x32x2,9/140	-	200	m
1118582	2x40x3,7 /175	-	200	m
1118583	2x50x4,6/175	-	200	m
1118584	2x63x5,8/200	-	100	m
1118585	2x75x6,8/250	-	100	m



art.nr.	omschrijving	LE	VPE	eenheid
---------	--------------	----	-----	---------

Uponor Ecoflex Thermo

Uponor Ecoflex Thermo Single

 1018109	25x2,3/140	-	200	m
1018110	32x2,9/140	-	200	m
1018111	40x3,7/175	-	200	m
1018112	50x4,6/175	-	200	m
1018113	63x5,8/175	-	200	m
1018114	75x6,8/200	-	100	m
1018115	90x8,2/200	-	100	m
1018116	110x10,0/200	-	100	m

Uponor Ecoflex Thermo Twin

 1018134	2x25x2,3/175	-	200	m
1018135	2x32x2,9/175	-	200	m
1018136	2x40x3,7 /175	-	200	m
1018137	2x50x4,6/200	-	100	m
1018138	2x63x5,8/200	-	100	m

Uponor Ecoflex Thermo Mini

 1018132	25x2,3/68	-	200	m
1018133	32x2,9/68	-	200	m
1095574	32x2,9/68 L=25m	50	25	m



Uponor Ecoflex Thermo Mini
De slimme monobloc-warmtepomp aansluiting: kleine buig radius, eenvoudig te installeren!

Lokale warmtedistributie

art.nr.	omschrijving	LE	VPE	eenheid	prijs/eenheid
---------	--------------	----	-----	---------	---------------

Uponor Ecoflex VIP Aqua

Uponor Ecoflex VIP Aqua Single

 1119047	40x5,5/140	-	200	m	
1119048	50x6,9/140	-	200	m	
1119049	63x8,6/140	-	200	m	

Uponor Ecoflex VIP Aqua Twin

 1119053	25x3,5-20x2,8/140	-	200	m	
1119054	32x4,4-20x2,8/140	-	200	m	
1119055	40x5,5-25x3,5/140	-	200	m	
1119056	50x6,9-32x4,4/175	-	200	m	



art.nr.	omschrijving	LE	VPE	eenheid	
---------	--------------	----	-----	---------	--

Uponor Ecoflex Aqua

Uponor Ecoflex Aqua Single

 1018117	25x3,5/140	-	200	m	
1018118	32x4,4/140	-	200	m	
1018119	40x5,5/175	-	200	m	
1018120	50x6,9/175	-	200	m	
1018121	63x8,6/175	-	200	m	

Uponor Ecoflex Aqua Twin

 1018139	25x3,5-25x3,5/175	-	200	m	
1018140	32x4,4-25x3,5/175	-	200	m	
1018141	40x5,5-25x3,5/175	-	200	m	
1018142	50x6,9-25x3,5/175	-	200	m	

Warmte- en koudedistributie

Lokale warmtedistributie

art.nr.	omschrijving	LE	VPE	eenheid
---------	--------------	----	-----	---------

Uponor Ecoflex Quattro

Uponor Ecoflex Quattro

 1018147	2x25x2,3-2x25x3,5/175	-	200	m
1018148	2x32x2,9-2x25x3,5/175	-	200	m
1018149	2x32x2,9-32x4,4-25x3,5/175	-	200	m

Uponor Ecoflex Supra

Uponor Ecoflex Supra

 1095722	25x2,3/68	-	200	m
1095723	32x2,9/68	-	200	m
1095724	40x3,7/140	-	200	m
1095725	50x4,6/140	-	200	m
1095726	63x5,8/140	-	200	m
1095727	75x6,8/175	-	150	m
1095728	90x8,2/175	-	100	m
1095729	110x10,0/200	-	100	m

art.nr.	omschrijving	LE	VPE	eenheid
---------	--------------	----	-----	---------

Uponor Ecoflex Supra PLUS

Uponor Ecoflex Supra PLUS cable

 1095730	25x2,3/68 1x10W/m	-	150	m
1095731	32x2,9/68 1x10W/m	-	150	m
1095734	40x3,7/140 1x10W/m	-	150	m
1095736	50x4,6/140 1x10W/m	-	150	m
1095737	63x5,8/140 1x10W/m	-	150	m
1095738	75x6,8/175 1x10W/m	-	150	m
1095739	90x8,2/200 1x10W/m	-	100	m
1095740	110x10,0/200 1x10W/m	-	100	m

Uponor Ecoflex Supra PLUS Set

 1120124	25+32/68	-	1	set
1120126	40+50+63/140	-	1	set
1120127	75/175	-	1	set
1120128	90+110/200	-	1	set

Uponor Ecoflex Supra PLUS Regelaar 150

 1120123		50	1	st.
--	--	----	---	-----

Uponor Ecoflex Supra PLUS kabelset S1

 1042310		-	1	st.
--	--	---	---	-----

Uponor Ecoflex Supra PLUS kabelset S2

 1042311		-	1	st.
--	--	---	---	-----

Uponor Ecoflex Supra PLUS T-set

 1061641	140/90/68	5	1	st.
1061642	200/175/140	3	1	st.

Uponor Ecoflex reduceerring

 1060991	200/68	8	1	st.
--	--------	---	---	-----

Uponor Wipex

art.nr.	omschrijving	LE	VPE	eenheid	prijs/eenheid
Uponor Wipex overgangspuntstuk PN6					
 1018328	25x2,3-G1	40	1	st.	
1018329	32x2,9-G1	20	1	st.	
1018330	40x3,7-G1 ¼	10	1	st.	
1018331	50x4,6-G1 ¼	10	1	st.	
1018332	63x5,8-G2	8	1	st.	
1018333	75x6,8-G2	6	1	st.	
1018334	90x8,2-G3	4	1	st.	
1018335	110x10,0-G3	3	1	st.	

Uponor Ecoflex overgangspuntstuk PN6

 1078368	125x11,4-R4	-	1	st.	
--	-------------	---	---	-----	--

Uponor Ecoflex overgangspuntstuk PN10

 1091505	20x2,8-¾"	10	1	st.	
--	-----------	----	---	-----	--

Uponor Wipex overgangspuntstuk PN10

 1018336	25x3,5-G1	40	1	st.	
1018338	32x4,4-G1	20	1	st.	
1018339	40x5,5-G1 ¼	10	1	st.	
1018340	50x6,9-G1 ¼	10	1	st.	
1018341	63x8,6-G2	8	1	st.	

Uponor Wipex koppeling PN6

 1042972	25x2,3-25x2,3	30	1	st.	
1042973	32x2,9-32x2,9	25	1	st.	
1042980	40x3,7-40x3,7	15	1	st.	
1042984	50x4,6-50x4,6	10	1	st.	
1042981	63x5,8-63x5,8	5	1	st.	
1042985	75x6,8-75x6,8	3	1	st.	
1042986	90x8,2-90x8,2	4	1	st.	
1042987	110x10-110x10	2	1	st.	

Uponor Ecoflex koppeling PN6

 1078365	125x11,4-125x11,4	-	1	st.	
--	-------------------	---	---	-----	--

art.nr.	omschrijving	LE	VPE	eenheid	prijs/eenheid
Uponor Wipex koppeling PN10					
 1042970	25x3,5-25x3,5	40	1	st.	
1042974	32x4,4-32x4,4	25	1	st.	
1042979	40x5,5-40x5,5	15	1	st.	
1042983	50x6,9-50x6,9	10	1	st.	
1042982	63x8,6-63x8,6	4	1	st.	

Uponor Wipex T-stuk binnendraad

 1018345	G1-G1-G1	20	1	st.	
1018346	G1 ¼-G1 ¼-G1 ¼	10	1	st.	
1018347	G2-G2-G2	4	1	st.	
1018348	G3-G3-G3	3	1	st.	

Uponor Ecoflex T-stuk

 1078367	Rp4-Rp4-Rp4	-	1	st.	
--	-------------	---	---	-----	--

Uponor Wipex knie binnendraad

 1018350	G1-G1	20	1	st.	
1018351	G1 ¼-G1 ¼	15	1	st.	
1018352	G2-G2	5	1	st.	
1018353	G3-G3	2	1	st.	

Uponor Ecoflex knie

 1078366	Rp4-Rp4	-	1	st.	
--	---------	---	---	-----	--

Uponor Wipex draadsok binnendraad

 1018355	G1-G1	40	1	st.	
1018356	G1 ¼-G1 ¼	25	1	st.	
1018357	G2-G2	15	1	st.	
1018358	G3-G3	10	1	st.	

Uponor Wipex

art.nr.	omschrijving	LE	VPE	eenheid
---------	--------------	----	-----	---------

Uponor Wipex reductie bu.dr./bi.dr.

	1018368 G1 1/4-G1	25	1	st.
	1018369 G1 1/2-G1 1/4	25	1	st.
	1018371 G2-G1	15	1	st.
	1018372 G2-G1 1/4	15	1	st.
	1018373 G2 1/2-G2	6	1	st.
	1018374 G3-G1	6	1	st.
	1018375 G3-G1 1/4	10	1	st.
	1018376 G3-G2	10	1	st.
	1009052 G4-G3	6	1	st.

Uponor Ecoflex reductie bu.dr./bi.dr.

	1078369 R4-G3	6	1	st.
---	----------------------	---	---	-----

Uponor Wipex draadflens binnendraad

	1018359 F25/4-85/G1	10	1	st.
	1018360 F32/4-100/G1 1/4	5	1	st.
	1018361 F40/4-110/G1 1/2	5	1	st.
	1018362 F50/4-125/G2	4	1	st.
	1018363 F65/8-145/2 1/2	3	1	st.
	1018364 F80/8-160/G3	3	1	st.
	1018365 F100/8-180/G4	3	1	st.

Uponor Ecoflex draadflens binnendraad

	1078370 F100/8-180/Rp4	-	1	st.
---	-------------------------------	---	---	-----

Uponor Wipex draadnippel buitendraad

	1045455 G1	20	1	st.
	1045456 G1 1/4-G1	20	1	st.
	1045457 G1 1/4	15	1	st.
	1065442 G1 1/4 120mm	8	1	st.
	1045458 G2-G1 1/4	10	1	st.
	1045459 G2	10	1	st.
	1065444 G2 120mm	3	1	st.
	1045460 G3-G2	3	1	st.
	1045461 G3	2	1	st.

art.nr.	omschrijving	LE	VPE	eenheid
---------	--------------	----	-----	---------

Uponor Wipex fixpuntsok bu.dr./bi.dr.

	1018302 G1	30	1	st.
	1018303 G1 1/4	10	1	st.
	1018304 G2	5	1	st.
	1018305 G3	5	1	st.

Uponor Ecoflex Aanlaskoppeling ST PN6 EU+GOST

	1094013 25x2,3-26,9	-	1	st.
	1094014 32x2,9-33,7	-	1	st.
	1094015 40x3,7-42,4	-	1	st.
	1094016 50x4,6-48,3	-	1	st.
	1094017 63x5,8-60,3	-	1	st.
	1094018 75x6,8-76,1	-	1	st.
	1094019 90x8,2-88,9	-	1	st.
	1094020 110x10,0-114,3	-	1	st.
	1094021 125x11,4-114,3	-	1	st.

Uponor Wipex MLC perskoppeling S-Press PN6

	1060058 32x2,9-32x3,0	25	1	st.
--	------------------------------	----	---	-----

Uponor Wipex MLC perskoppeling S-Press PN6

	1060059 40x3,7-40x4,0	15	1	st.
	1060060 50x4,6-50x4,5	10	1	st.

Uponor Wipex spreidtang

	1046407 1 - 1 1/2	25	1	st.
---	--------------------------	----	---	-----

Uponor Q&E

art.nr.	omschrijving	LE	VPE	een- heid	prijs/ eenheid
---------	--------------	----	-----	--------------	-------------------

Uponor Q&E zekeringsring white

	1057455 25	300	20	st.	
	1057456 32	150	10	st.	

Uponor Q&E ring met stop-edge natural

	1045464 40	80	5	st.	
	1045489 50	70	5	st.	
	1045490 63	35	5	st.	
	1085087 75	18	2	st.	

Uponor Q&E knie 90° PPSU

	1008681 25-25	25	5	st.	
	1001245 32-32	10	1	st.	
	1008683 40-40	10	1	st.	
	1042859 50-50	5	1	st.	
	1042858 63-63	3	1	st.	
	1085080 75-75	2	1	st.	

Uponor Q&E koppeling PPSU

	1008671 25-25	50	5	st.	
	1001235 32-32	15	1	st.	
	1008673 40-40	10	1	st.	
	1042866 50-50	10	1	st.	
	1042865 63-63	5	1	st.	
	1085084 75-75	10	1	st.	

Uponor Q&E koppeling verlopend PPSU

	1001240 32-25	20	1	st.	
	1008678 40-32	10	1	st.	
	1042879 50-32	10	1	st.	
	1042867 50-40	10	1	st.	
	1042878 63-40	5	1	st.	
	1042877 63-50	5	1	st.	
	1085086 75-50	10	1	st.	
	1085085 75-63	10	1	st.	

Uponor Q&E T-stuk PPSU

	1008686 25-25-25	20	5	st.	
	1001250 32-32-32	10	1	st.	
	1008688 40-40-40	5	1	st.	
	1042861 50-50-50	3	1	st.	
	1042860 63-63-63	2	1	st.	
	1085081 75-75-75	2	1	st.	

art.nr.	omschrijving	LE	VPE	een- heid	prijs/ eenheid
---------	--------------	----	-----	--------------	-------------------

Uponor Q&E T-stuk verlopend PPSU

	1008712 25-32-25	15	1	st.	
	1001426 32-25-25	15	1	st.	
	1001428 32-25-32	15	1	st.	
	1008713 32-40-32	10	1	st.	
	1008708 40-25-32	5	1	st.	
	1008695 40-25-40	5	1	st.	
	1008709 40-32-32	5	1	st.	
	1008696 40-32-40	5	1	st.	
	1042876 50-25-40	4	1	st.	
	1042864 50-25-50	4	1	st.	
	1042863 50-32-50	4	1	st.	
	1042862 50-40-40	4	1	st.	
	1042875 50-40-50	4	1	st.	
	1042871 63-25-50	2	1	st.	
	1042873 63-25-63	2	1	st.	
	1042870 63-32-63	2	1	st.	
	1042869 63-40-40	2	1	st.	
	1042872 63-40-63	2	1	st.	
	1042868 63-50-50	2	1	st.	
	1042874 63-50-63	2	1	st.	
	1085083 75-25-75	4	1	st.	
	1085082 75-40-75	4	1	st.	

Uponor Q&E puntstuk PL

	1023007 25-R $\frac{3}{4}$ "MT	70	5	st.	
	1047191 32-R1"MT	10	1	st.	

Uponor Q&E reduceernippel PL/DR

	1085077 40-R1 $\frac{1}{4}$ "MT	16	1	st.	
	1085076 50-R1 $\frac{1}{2}$ "MT	8	1	st.	
	1085075 63-R2"MT	6	1	st.	
	1085074 75-R2 $\frac{1}{2}$ "MT	6	1	st.	

Uponor Q&E knie binnendraad PL

	1023026 25-G $\frac{3}{4}$ "FT	35	5	st.	
---	--------------------------------	----	---	-----	--

Uponor Q&E schroefbus PL

	1023012 25-Rp $\frac{3}{4}$ "FT	40	5	st.	
---	---------------------------------	----	---	-----	--

Uponor Ecoflex systeemtoebehoren

art.nr.	omschrijving	LE	VPE	eenheid
---------	--------------	----	-----	---------

Uponor Ecoflex rubberen eindkap Single

	1018316 25+32+40/68	-	1	st.
	1018315 25+28+32/140	-	1	st.
	1018313 32+40+50/175	-	1	st.
	1018314 40+50+63/140	-	1	st.
	1095801 63+75+90/140	-	1	st.
	1018312 63+75/175	-	1	st.
	1018310 75+90+110/200	-	1	st.
	1018311 90+110/175	-	1	st.
	1067757 125/200	-	1	st.

Uponor Ecoflex rubberen eindkap Twin

	1119374 18-22+25-28+32/140	-	1	st.
	1018245 25+32+40/140	-	1	st.
	1018309 25+32+40/175	-	1	st.
	1018308 25+32+50/175	-	1	st.
	1018307 40+50+63/200	-	1	st.
	1088979 75+90/250	-	1	st.

Uponor Ecoflex rubberen eindkap Quattro

	1018306 18-32+25-32/175	-	1	st.
---	--------------------------------	---	---	-----

Uponor Ecoflex isolatieset T-stuk

	1060986 140/90/68	5	1	st.
	1060982 200/175/140	4	1	st.
NEW	1121805 200/200/175/140	3	1	st.

Uponor Ecoflex isolatieset haaks

	1060985 200/175/140	3	1	st.
---	----------------------------	---	---	-----

Uponor Ecoflex isolatieset recht

	1060984 200/175/140	6	1	st.
NEW	1121806 250	4	1	st.

art.nr.	omschrijving	LE	VPE	eenheid
---------	--------------	----	-----	---------

Uponor Ecoflex reduceerring

	1060991 200/68	8	1	st.
	1085107 200/160	12	1	st.
NEW	1121807 250/250	-	1	st.
NEW	1121808 250/200	-	1	st.
NEW	1121809 250/175	-	1	st.
NEW	1122070 250/140	-	1	st.

Uponor Ecoflex H-isolatieset

	1007355 200/175/140	-	1	st.
---	----------------------------	---	---	-----

Uponor Ecoflex inspectieput

	1018326 6x140/145/175/200	-	3	st.
	1018327 8x140/145/175/200	-	3	st.
	1084576 2x250-6x140/175/200	-	1	st.
	1084577 4x250-4x140/175/200	-	1	st.
	1084578 6x250-2x140/175/200	-	1	st.

Uponor Ecoflex tape inspectieput

	1018382 50mm x 10m	-	1	st.
---	---------------------------	---	---	-----

Uponor Ecoflex krimpslang inspectieput

	1018379 140	-	1	st.
	1018380 175/200	-	1	st.
	1084575 250	15	1	st. 89,45

Uponor Ecoflex huisaansluiting haaks Single

	1118767 75x6,8/140	-	1	st.
---	---------------------------	---	---	-----

Levertijd op aanvraag

Uponor Ecoflex huisaansluiting haaks Twin

	1118771 2x25x2,3/140	-	1	st.
	1118772 2x32x2,9/140	-	1	st.
	1118773 2x40x3,7/160	-	1	st.
	1118774 2x50x4,6/200	-	1	st.
	1118775 2x63x5,8/200	-	1	st.
	1118776 2x75x6,8/250	-	1	st.

Levertijd op aanvraag.

Uponor Ecoflex reduceerring

	1085107 200/160	12	1	st.
---	------------------------	----	---	-----

Uponor Ecoflex systeemtoebehoren

art.nr.	omschrijving	LE	VPE	eenheid	prijs/eenheid
Uponor Ecoflex muurdoorvoering DWD					
 1007358	68	-	1	st.	
1007360	140	-	1	st.	
1007361	175	-	1	st.	
1007362	200	-	1	st.	
1091429	250	-	1	st.	

art.nr.	omschrijving	LE	VPE	eenheid	prijs/eenheid
Uponor Ecoflex verst.muurdoorvoering DWD					
 1007365	140	-	1	st.	
1007366	175	-	1	st.	
1007367	200	-	1	st.	
1091430	250	-	1	st.	

art.nr.	omschrijving	LE	VPE	eenheid	prijs/eenheid
Uponor Ecoflex vezelcementbuis DWD					
 1007368	68	-	1	st.	
1007370	140	-	1	st.	
1007371	175	-	1	st.	
1007372	200	-	1	st.	

art.nr.	omschrijving	LE	VPE	eenheid	prijs/eenheid
Uponor Ecoflex epoxyharset DWD					
 1007373	1,1 kg/3,5m ²	-	1	set	

art.nr.	omschrijving	LE	VPE	eenheid	prijs/eenheid
Uponor Ecoflex muurdoorvoering NWD					
 1018267	68+90	-	1	st.	
1018269	140	-	1	st.	
1018268	175+200	-	1	st.	
1083871	250	16	1	st.	

art.nr.	omschrijving	LE	VPE	eenheid	prijs/eenheid
Uponor Ecoflex labirynth afdichting NDW					
 1034202	140	40	1	st.	
1034203	175	30	1	st.	
1034204	200	20	1	st.	
1090415	250	-	1	st.	

art.nr.	omschrijving	LE	VPE	eenheid	prijs/eenheid
Uponor Ecoflex krimpmanchet					
 1036014	140+175+200-700mm	-	1	st.	

art.nr.	omschrijving	LE	VPE	eenheid	prijs/eenheid
Uponor Ecoflex spreidkrammen					
 1021997		-	1	st.	0,33

art.nr.	omschrijving	LE	VPE	eenheid	prijs/eenheid
Uponor Ecoflex schroevenset					
 1021999	voor H-isolatieset	-	1	st.	1,09

art.nr.	omschrijving	LE	VPE	eenheid	prijs/eenheid
Uponor Ecoflex krimpband					
 1093120	160mm x 10m	30	1	st.	

art.nr.	omschrijving	LE	VPE	eenheid	prijs/eenheid
Uponor Ecoflex markeringstape rood					
 1018385	40mm x 250m	-	1	st.	
1105785	40mm x 30m	-	1	st.	

art.nr.	omschrijving	LE	VPE	eenheid	prijs/eenheid
Uponor Multi buissnijder					
 1089677	32-40	12	1	st.	
1089779	32-40 verv.mes*	50	1	st.	

art.nr.	omschrijving	LE	VPE	eenheid	prijs/eenheid
Uponor Flex buissnijder PEX					
 1095265	50-63	12	1	st.	
1095266	50+63 verv.mes* 50	1	1	st.	

OUT Artikel is uitlopend.
Levering zolang de voorraad strekt.

art.nr.	omschrijving	LE	VPE	eenheid	prijs/eenheid
Uponor Multi buissnijder					
 1089675	25-63	12	1	st.	
1089777	25-63 verv.mes*	50	1	st.	

art.nr.	omschrijving	LE	VPE	eenheid	prijs/eenheid
Uponor Multi buissnijder					
 1089676	50-125	8	1	st.	
1089778	50-125 verv.mes*	50	1	st.	

art.nr.	omschrijving	LE	VPE	eenheid	prijs/eenheid
Uponor MLC universele ontbramer 40-110 mm					
 1060167		50	1	st.	

art.nr.	omschrijving	LE	VPE	eenheid	prijs/eenheid
Uponor Wipex spreidtang					
 1046407	1 - 1 1/2	25	1	st.	

art.nr.	omschrijving	LE	VPE	eenheid	prijs/eenheid
Uponor Q&E grafietpasta					
 1005017	100g	-	1	st.	

art.nr.	omschrijving	LE	VPE	eenheid	prijs/eenheid
Uponor Ecoflex afdichtingskit					
 1060996	290ml	-	1	st.	

art.nr.	omschrijving	LE	VPE	eenheid	prijs/eenheid
Uponor Ecoflex schroevenset					
 1060995	voor T-, hoek- of langisolatiesets	-	1	st.	

art.nr.	omschrijving	LE	VPE	eenheid	prijs/eenheid
Uponor Ecoflex Supra PLUS antivrieskabel					
 1044136	10W/m	-	1	m	

Gereedschappen

art.nr.	omschrijving	LE	VPE	eenheid
---------	--------------	----	-----	---------

Verleggen

Uponor MLC leidinguitlijner

	1010512 14-25	60	1	st.
---	---------------	----	---	-----

Uponor Multi telescoop leidinghaspel

	1058662	-	1	st.
---	---------	---	---	-----

Uponor Multi leidinghaspel

	1006255 120-960M	-	1	st.
---	------------------	---	---	-----

Uponor Magna leidinghaspel

	1006256 25-640m	-	1	st.
---	-----------------	---	---	-----

Uponor Magna Unwinder

	NEW 1135500	21	1	st.	2113,96
---	--------------------	----	---	-----	---------

art.nr.	omschrijving	LE	VPE	eenheid
---------	--------------	----	-----	---------

Vorbereiden, snijden, buigen

Uponor Multi buis en mantelbuissnijder

	1089674 12-25	36	1	st.
	1089776 12-25	150	1	st.

Uponor Multi buissnijder

	1089677 32-40	12	1	st.
	1089779 32-40 verv.mes*	50	1	st.

Uponor Flex buissnijder PEX

	OUT 1095265 50-63	12	1	st.
	OUT 1095266 50+63 verv.mes* 50	50	1	st.

OUT Artikel is uitlopend.
Levering zolang de voorraad strekt.

Uponor Multi buissnijder

	1089675 25-63	12	1	st.
	1089777 25-63 verv.mes*	50	1	st.

Uponor Multi buissnijder

	1089676 50-125	8	1	st.
	1089778 50-125 verv.mes*	50	1	st.

Uponor Flex buissnijder PEX

	1089673 12-25	36	1	st.
	1089780 12-25 verv.mes*	150	1	st.

Uponor MLC vervangingsnijwiel

	1006635 25-63	1000	1	st.
	1014173 50-110	20	1	st.

Uponor MLC buissnijder- en ontbraamset

	1014334 63-110	32	1	st.
	1014320 63-110 verv.mes*	100	1	st.

* = vervangingsmes / - snijwiel

Gereedschappen

art.nr.	omschrijving	LE	VPE	een- heid	prijs/ eenheid
---------	--------------	----	-----	--------------	-------------------

Vorbereiden, snijden, buigen

Uponor MLC ontbramer

 1006952	14	50	1	st.
1006830	16	50	1	st.
1015749	20	1200	1	st.
1015756	25	960	1	st.
1015762	32	900	1	st.

Uponor MLC ontbramer

 1006638	40	600	1	st.
1015808	50	600	1	st.
1014339	63	600	1	st.
1014344	75	600	1	st.

Uponor MLC combi-ontbramer

 1015739	16/20/25	60	1	st.
--	----------	----	---	-----

Uponor MLC universele ontbramer 40-110 mm

 1060167		50	1	st.
--	--	----	---	-----

Uponor MLC binnen-buigveer

 1013727	14	1000	1	st.
1013729	16	100	1	st.
1013734	20	75	1	st.
1013737	25	50	1	st.
1013739	32	40	1	st.

Uponor MLC buiten-buigveer

 1006639	14	550	1	st.
1006640	16	55	1	st.
1013792	20	45	1	st.
1013794	25	45	1	st.

art.nr.	omschrijving	LE	VPE	een- heid
---------	--------------	----	-----	--------------

Uponor Uni Pipe PLUS buiggereedschap

 1071925	16-32	100	1	st.
--	-------	-----	---	-----

Uponor Uni Pipe PLUS buigsegment

 1120408	R32 16	10	1	st.
1120409	R40 20	10	1	st.
1120410	R62,5 25	10	1	st.
1120411	R80 32	10	1	st.

Uponor RTM combi kalibreer

 1048606	16/20/25	20	1	st.
--	----------	----	---	-----

Gereedschappen

art.nr.	omschrijving	LE	VPE	eenheid
---------	--------------	----	-----	---------

Persen

Uponor S-Press accu-gereedschapspakket BENELUX

	1083584 16/20/25	10	1	set
	1083585 16/20/25/32	10	1	set
netto installateur				

Uponor S-Press accu persmachine UP110 zonder persbekken

	1083612	20	1	set
---	----------------	----	---	-----

Uponor S-Press reserve accu UP110

	1083608	10	1	st.
---	----------------	----	---	-----

Uponor S-Press reserve acculader

	1083610 Mini2, UP110	72	1	st.
---	-----------------------------	----	---	-----

Uponor S-Press elek.persmachine z.persbek UP75

	1007082	20	1	st.
---	----------------	----	---	-----

Uponor S-Press persbek UPP1

	1007083 14	280	1	st.
	1007084 16	216	1	st.
	1007086 20	-	1	st.
	1007087 25	-	1	st.
	1007088 32	-	1	st.

Uponor S-Press persbek UPP1

	1015768 40	108	1	st.
	1015792 50	108	1	st.

Uponor S-Press basispersbek

	1046545 63-110	-	1	st.
---	-----------------------	---	---	-----

Uponor S-Press persketting

	1046541 63	72	1	st.
	1046542 75	72	1	st.
	1046543 90	72	1	st.
	1046544 110	54	1	st.

art.nr.	omschrijving	LE	VPE	eenheid
---------	--------------	----	-----	---------

Uponor S-Press accupersmachine Mini2 met Mini KSP0 persbek

	1083586 16/20/25/32	30	1	set
netto installateur				

Uponor S-Press accupersmachine Mini2 met Mini KSP0 persbek

	1083594 16/20/25	25	1	set
netto installateur				

Uponor S-Press persbek Mini2 KSP0

	1007090 14	5	1	st.
	1007091 16	5	1	st.
	1007093 20	5	1	st.
	1007094 25	5	1	st.
	1007095 32	5	1	st.
netto installateur				

Uponor S-Press reserve accu Mini2

	1083605	48	1	st.
netto installateur				

Uponor S-Press reserve acculader

	1083610 Mini2, UP110	72	1	st.
---	-----------------------------	----	---	-----

Uponor S-Press handperstang inzetbek

	1015764 14-20	100	1	st.
<i>LET OP! Niet geschikt voor monteren en persen van het Uponor GAS Press systeem</i>				

Uponor S-Press inzetbek handperstang

	1015776 14	400	1	st.
	1015777 16	50	1	st.
	1015780 20	50	1	st.
<i>LET OP! Niet geschikt voor monteren en persen van het Uponor GAS Press systeem</i>				

Uponor S-Press handperstangset BENELUX

	1013778 14-20	20	1	st.
netto installateur				
<i>LET OP! Niet geschikt voor monteren en persen van het Uponor GAS Press systeem</i>				

Gereedschappen

art.nr.	omschrijving	LE	VPE	eenheid	prijs/eenheid
---------	--------------	----	-----	---------	---------------

art.nr.	omschrijving	LE	VPE	eenheid	prijs/eenheid
---------	--------------	----	-----	---------	---------------

Expanderen

Uponor Minitec expansiegereedschap

	1006247	9,9x1,1	11	1	set
---	----------------	---------	----	---	-----

Uponor Q&E expansiegereedschap met expansiekop M12

	OUT 1063112	6bar 9,9/20	-	1	set
	OUT 1057166	16/20/25 6bar	-	1	set
	OUT 1057167	16/20/25 10bar	-	1	set

In de koffer bij deze Uponor Q&E accu-expansiemachine M12 zitten de expansiekoppen verpakt voor de diameters en toepassing zoals in de artikelomschrijving staat vermeld.

Uponor Q&E RS expansiegereedschap met expansiekop M12

	1119375	6bar 9,9RS/20	-	1	set
	1119376	16RS/20/25 6bar	-	1	set
	1119379	16RS/20/25 10bar	-	1	set

Uponor Q&E expansiekop M12/Rapid Seal

	1119380	9,9x1,1	-	1	st.
---	----------------	---------	---	---	-----

Uponor Q&E expansiekop M12/M18

	1057171	12x1,1/1,7/1,8/2,0	-	1	st.
	1057184	14/15x2,5	-	1	st.
	OUT 1057172	16x1,8/2,0/2,2	-	1	st.
	1057185	17/18x2,5	-	1	st.
	OUT 1057173	20x1,9/2,0	-	1	st.
	OUT 1057175	25x2,3	-	1	st.
	OUT 1057176	25x3,5	-	1	st.
	OUT 1057177	32x2,9	-	1	st.

OUT Artikel is uitlopend.
Levering zolang de voorraad strekt.

Uponor Q&E expansiekop M12/M18/Rapid Seal

	1119381	16x1,8/2,0/2,2	-	1	st.
	1119382	20x1,9/2,0	-	1	st.
	1119383	20x2,8	-	1	st.
	1119384	25x2,3	-	1	st.
	1119385	25x3,5	-	1	st.
	1119386	32x2,9	-	1	st.

Uponor Q&E reserve accu exp.machine M12

	1061185	4Ah	12	1	st.
---	----------------	-----	----	---	-----

Uponor Q&E expansiegereedschap m.exp.kop M18 6bar

	1063908	16/20/25/32	-	1	set
---	----------------	-------------	---	---	-----

In de koffer bij deze Uponor Q&E accu-expansiemachine M18 zitten de expansiekoppen verpakt voor de diameters en toepassing zoals in de artikelomschrijving staat vermeld.

Uponor Q&E expansiegereedschap m.exp.kop M18 10bar

	1063909	16/20/25/H32	-	1	set
---	----------------	--------------	---	---	-----

In de koffer bij deze Uponor Q&E accu-expansiemachine M18 zitten de expansiekoppen verpakt voor de diameters en toepassing zoals in de artikelomschrijving staat vermeld.

Uponor Q&E expansiekop M18 H

	1057182	32x2,9/4,4	-	1	st.
	1057183	40x3,7	-	1	st.

Uponor Q&E Uponor Q&E exp. gereedschap M18 VLD PEX

	1085099	40-75	-	1	st.
---	----------------	-------	---	---	-----

Uponor Q&E expansiekop VLD

	1085095	40x3,7/5,5	-	1	st.
	1085096	50x4,6/6,9	-	1	st.
	1085097	63x5,8/8,6	-	1	st.
	1085098	75x6,8/10,3	-	1	st.

Uponor Q&E accu exp. gereedschap M18 PEX

	1085100	5,0Ah	-	1	st.
---	----------------	-------	---	---	-----

Uponor Q&E acculader exp. gereedsch. M12/M18 PEX

	1085101	220-240V/50-60Hz	-	1	st.
---	----------------	------------------	---	---	-----

Uponor Q&E grafietpasta

	1005017	100g	-	1	st.
---	----------------	------	---	---	-----

Gereedschappen

art.nr.	omschrijving	LE	VPE	eenheid
---------	--------------	----	-----	---------

Bevestigen

Uponor Siccus 14 polystyreensnijder

 1006290	14mm 230V	20	1	st.
--	-----------	----	---	-----

Uponor Tacker Tool

 1119039	14-20mm	50	1	st.
--	---------	----	---	-----

Uponor Multi plakbandroller

 1000142		20	1	st.
--	--	----	---	-----

Uponor Classic Clipmaster

 1006295	16/17mm l=920mm	100	1	st.
1006309	20mm l=920mm	-	1	st.

Uponor Classic drilapparaat voor matbinders

 1006243	l=320mm	50	1	st.
--	---------	----	---	-----

Uponor Multi leidinggeleider

 1088066		-	1	st.
--	--	---	---	-----

art.nr.	omschrijving	LE	VPE	eenheid
---------	--------------	----	-----	---------

Overige

Uponor Rapex persbek

 1006330	14x2	-	1	st.
1006332	16x2	8	1	st.
1006343	17x2	-	1	st.

Uponor Smart Aqua buigtang voor montageplaat

 1015424	2m	100	1	st.
--	----	-----	---	-----

De Uponor prijslijst downloaden:



Direct naar het downloaden
van de prijslijst Benelux 2023

- Technische en inhoudelijke wijzigingen voorbehouden
- Meer informatie:
www.uponor.nl / www.nathan.nl
www.uponor.be / www.nathan.be

Alle wettelijke en technische informatie werd naar beste weten zorgvuldig samengesteld. Fouten kunnen echter niet volledig worden uitgesloten en hiervoor wordt geen aansprakelijkheid aanvaard. Het werk is inclusief al zijn onderdelen auteursrechtelijk beschermd. Iedere toepassing buiten de door de auteurswet toegestane uitzonderingen is zonder toestemming van Uponor GmbH niet geoorloofd.

Technische wijzigingen voorbehouden.

© 2023

Uponor GmbH, Haßfurt

Moving > Water

Uponor

Uponor GmbH

Industriestraße 56
97437 Hassfurt
Germany

www.uponor.com



Nathan Systems BV

Mega 2
6902 KL, Zevenaar
Nederland
T +31 (0)26-445 98 45
F +31 (0)26-445 93 73
W www.nathan.nl
E info@nathan.nl

W www.uponor.nl
E info.nl@uponor.com

Nathan Systems NV/SA

Lozenberg 4
1932 Zaventem
België
T +32 (0)2 721 15 70
F +32 (0)2 725 35 53
W www.nathan.be
E info@nathan.be

W www.uponor.be
E info.be@uponor.com