

# Data Sheet | Item Number: 721-603/114-042

1-conductor male connector; CAGE CLAMP®; 2.5 mm²; Pin spacing 5 mm; 3-pole; Preceding ground contact; 100% protected against mismatching; Snap-in flange; direct marking; 2,50 mm²; light gray



<https://www.wago.com/721-603/114-042>



Color: ■ light gray

Similar to illustration

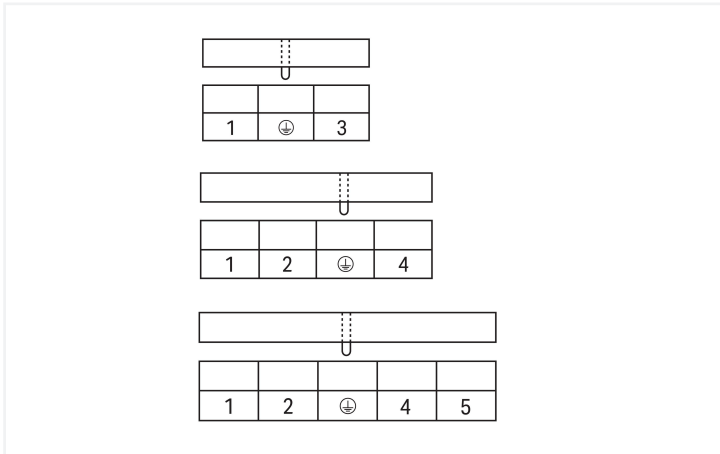
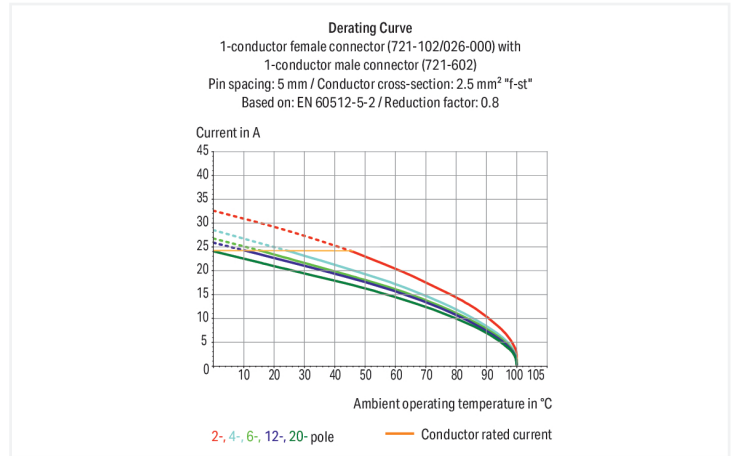

Preceding PE contact position

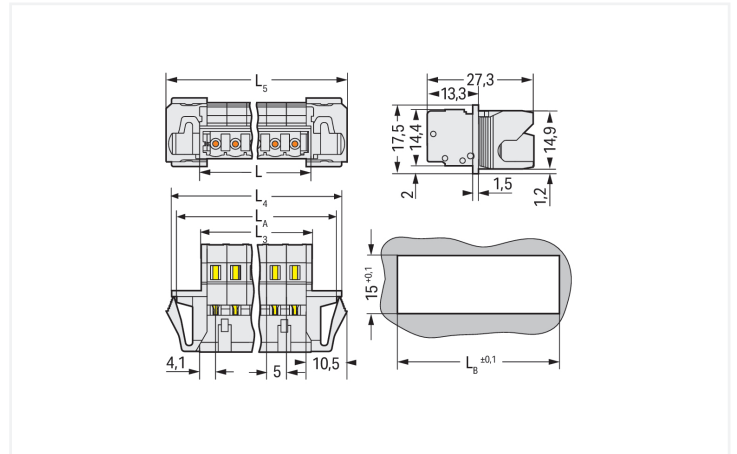

Dimensions in mm

$L = (\text{pole no.} \times \text{pin spacing}) + 3.2 \text{ mm}$   
 $L_3 = L - 0.2 \text{ mm}$   
 $L_4 = L_3 + 15.2 \text{ mm}$   
 $L_5 = L_3 + 18 \text{ mm}$   
 $L_A = L_3 + 12.6 \text{ mm}$   
 $L_B = L_3 + 13.2 \text{ mm}$

Male connector, 721 Series, light gray

Our male connector (item number 721-603/114-042) ensures effortless electrical installations. Ensure that the strip lengths are between 8 and 9 mm when connecting conductors to this male connector. This product incorporates one conductor terminal and utilizes CAGE CLAMP®. Our CAGE CLAMP® connection offers a dependable and maintenance-free way to connect all types of conductors. You do not need to prepare the conductor in any way, such as crimping ferrules. Dimensions: (36 x 17.5 x 27.5) mm (width x height x depth). Depending on the type of conductor, this male connector is suitable for conductor cross sections ranging from 0.08 mm² to 2.5 mm².

The contact surface is coated with tin.

## Notes

## Safety Information

The MCS – MULTI CONNECTION SYSTEM includes connectors without breaking capacity in accordance with DIN EN 61984. When used as intended, these connectors must not be connected/disconnected when live or under load. When used as intended, these connectors must not be connected/disconnected when live or under load. The circuit design should ensure header pins, which can be touched, are not live when unmated.

## Variants:

Other pole numbers  
Gold-plated or partially gold-plated contact surfaces  
Other versions (or variants) can be requested from WAGO Sales or configured at <https://configurator.wago.com/>.

## Electrical data

| Ratings per                     | IEC/EN 60664-1 |       |       |
|---------------------------------|----------------|-------|-------|
| Overvoltage category            | III            | III   | II    |
| Pollution degree                | 3              | 2     | 2     |
| Nominal voltage                 | 320 V          | 320 V | 630 V |
| Rated impulse withstand voltage | 4 kV           | 4 kV  | 4 kV  |
| Rated current                   | 12 A           | 12 A  | 12 A  |

| Approvals per | UL 1059 |   |       |
|---------------|---------|---|-------|
| Use group     | B       | C | D     |
| Rated voltage | 300 V   | - | 300 V |
| Rated current | 15 A    | - | 10 A  |

| Approvals per | UL 1977 |
|---------------|---------|
| Rated voltage | 600 V   |
| Rated current | 15 A    |

| Approvals per | CSA   |   |       |
|---------------|-------|---|-------|
| Use group     | B     | C | D     |
| Rated voltage | 300 V | - | 300 V |
| Rated current | 15 A  | - | 10 A  |

## Connection Data

|                            |                      |
|----------------------------|----------------------|
| Clamping units             | 3                    |
| Total number of potentials | 3                    |
| Number of connection types | 1                    |
| Number of levels           | 1                    |
| PE function                | Preceding PE contact |

| Connection 1                                      |  |
|---|--|
| Connection technology                             | CAGE CLAMP®                                  |
| Actuation type                                    | Operating tool                               |
| Actuation direction 1                             | Operation parallel to conductor entry        |
| Actuation direction 2                             | Operation perpendicular to conductor entry   |
| Solid conductor                                   | 0.08 ... 2.5 mm <sup>2</sup> / 28 ... 12 AWG |
| Fine-stranded conductor                           | 0.08 ... 2.5 mm <sup>2</sup> / 28 ... 12 AWG |
| Fine-stranded conductor; with insulated ferrule   | 0.25 ... 1.5 mm <sup>2</sup>                 |
| Fine-stranded conductor; with uninsulated ferrule | 0.25 ... 2.5 mm <sup>2</sup>                 |
| Strip length                                      | 8 ... 9 mm / 0.31 ... 0.35 inches            |
| Pole number                                       | 3  |
| Conductor entry direction to mating direction     | 0°   |

## Physical data

|             |                        |
|-------------|------------------------|
| Pin spacing | 5 mm / 0.197 inches    |
| Width       | 36 mm / 1.417 inches   |
| Height      | 17.5 mm / 0.689 inches |
| Depth       | 27.5 mm / 1.083 inches |

### Mechanical data

|   |  |
|---|--|
| Variable coding                         | Yes                                    |
| Housing sheet thickness                 | 0.5 ... 2.5 mm / 0.02 ... 0.098 inches |
| Mounting type                           | Snap-in flange                         |
| Mounting type                           | Feed-through mounting                  |
| Anti-rotation protection                | Yes                                    |
| Suitable for through-panel applications | Yes                                    |

### Plug-in connection

|                                    |                     |
|------------------------------------|---------------------|
| Contact type (pluggable connector) | Male connector/plug |
| Connector (connection type)        | for conductor       |
| Mismating protection               | Yes                 |

### Material data

|                                    |  |
|------------------------------------|--|
| Note (material data)               | <a href="#">Information on material specifications can be found here</a> |
| Color                              | light gray   |
| Material group                     | I  |
| Insulation material (main housing) | Polyamide (PA66)   |
| Flammability class per UL94        | V0   |
| Clamping spring material           | Chrome-nickel spring steel (CrNi)  |
| Contact material                   | Electrolytic copper (E <sub>cu</sub> )                                   |
| Contact Plating                    | Tin  |
| Fire load                          | 0.155 MJ   |
| Weight                             | 7.1 g  |

### Environmental requirements

|                         |                 |
|-------------------------|-----------------|
| Limit temperature range | -60 ... +100 °C |
| Processing temperature  | -35 ... +60 °C  |

### Commercial data

|                       |                        |
|-----------------------|------------------------|
| Product Group         | 3 (Multi Conn. System) |
| PU (SPU)              | 50 pcs                 |
| Packaging type        | Box                    |
| Country of origin     | DE                     |
| GTIN                  | 4050821280590          |
| Customs tariff number | 85366930000            |

### Product Classification

|             |                      |
|-------------|----------------------|
| UNSPSC      | 39121409             |
| eCl@ss 10.0 | 27-44-03-09          |
| eCl@ss 9.0  | 27-44-03-09          |
| ETIM 9.0    | EC002638             |
| ETIM 10.0   | EC002638             |
| ECCN        | NO US CLASSIFICATION |

**Environmental Product Compliance**

RoHS Compliance Status Compliant, No Exemption

**Approvals / Certificates**

**General approvals**



| Approval                              | Standard  | Certificate Name |
|---------------------------------------|-----------|------------------|
| CB<br>DEKRA Certification B.V.        | IEC 61984 | NL-113351        |
| CSA<br>DEKRA Certification B.V.       | C22.2     | 1466354          |
| KEMA/KEUR<br>DEKRA Certification B.V. | EN 61984  | 71-130478 REV.1  |
| UL<br>Underwriters Laboratories Inc.  | UL 1977   | E45171           |
| UL<br>Underwriters Laboratories Inc.  | UL 1059   | E45172           |

**Downloads**

**Environmental Product Compliance**

**Compliance Search**

|   |   |
|---|---|
| Environmental Product Compliance<br>721-603/114-042 | ↓ |
|---|---|

**Documentation**

**Additional Information**

|                   |            |                   |   |
|-------------------|------------|-------------------|---|
| Technical Section | 03.04.2019 | pdf<br>2027.26 KB | ↓ |
|-------------------|------------|-------------------|---|

**1 Compatible Products**

**1.1 System counterpart**

**1.1.1 Female connector/socket**



**Item No.: 721-103/026-000**  
 1-conductor female connector; CAGE CLAMP®; 2.5 mm<sup>2</sup>; Pin spacing 5 mm; 3-pole; 100% protected against mismatching; 2,50 mm<sup>2</sup>; light gray

1.2 Optional Accessories

1.2.1 Coding

1.2.1.1 Coding



**Item No.: 231-129**

Coding key; snap-on type; light gray

1.2.2 Cover

1.2.2.1 Cover



**Item No.: 231-668**

Lockout caps; for covering unused clamping units; gray

1.2.3 Ferrule

1.2.3.1 Ferrule



**Item No.: 216-301**

Ferrule; Sleeve for 0.25 mm<sup>2</sup> / AWG 24; insulated; electro-tin plated; yellow



**Item No.: 216-302**

Ferrule; Sleeve for 0.34 mm<sup>2</sup> / 22 AWG; insulated; electro-tin plated; light turquoise



**Item No.: 216-201**

Ferrule; Sleeve for 0.5 mm<sup>2</sup> / 20 AWG; insulated; electro-tin plated; electrolytic copper; acc. to DIN 46228, Part 4/09.90; white



**Item No.: 216-241**

Ferrule; Sleeve for 0.5 mm<sup>2</sup> / 20 AWG; insulated; electro-tin plated; electrolytic copper; gastight crimped; acc. to DIN 46228, Part 4/09.90; white



**Item No.: 216-141**

Ferrule; Sleeve for 0.5 mm<sup>2</sup> / 20 AWG; un-insulated; electro-tin plated; electrolytic copper; gastight crimped; acc. to DIN 46228, Part 1/08.92



**Item No.: 216-101**

Ferrule; Sleeve for 0.5 mm<sup>2</sup> / AWG 22; un-insulated; electro-tin plated; silver-colored



**Item No.: 216-242**

Ferrule; Sleeve for 0.75 mm<sup>2</sup> / 18 AWG; insulated; electro-tin plated; electrolytic copper; gastight crimped; acc. to DIN 46228, Part 4/09.90; gray



**Item No.: 216-262**

Ferrule; Sleeve for 0.75 mm<sup>2</sup> / 18 AWG; insulated; electro-tin plated; electrolytic copper; gastight crimped; acc. to DIN 46228, Part 4/09.90; gray



**Item No.: 216-202**

Ferrule; Sleeve for 0.75 mm<sup>2</sup> / 18 AWG; insulated; electro-tin plated; gray



**Item No.: 216-142**

Ferrule; Sleeve for 0.75 mm<sup>2</sup> / 18 AWG; un-insulated; electro-tin plated; electrolytic copper; gastight crimped; acc. to DIN 46228, Part 1/08.92



**Item No.: 216-102**

Ferrule; Sleeve for 0.75 mm<sup>2</sup> / AWG 20; un-insulated; electro-tin plated; silver-colored



**Item No.: 216-243**

Ferrule; Sleeve for 1 mm<sup>2</sup> / AWG 18; insulated; electro-tin plated; electrolytic copper; gastight crimped; acc. to DIN 46228, Part 4/09.90; red



**Item No.: 216-263**

Ferrule; Sleeve for 1 mm<sup>2</sup> / AWG 18; insulated; electro-tin plated; electrolytic copper; gastight crimped; acc. to DIN 46228, Part 4/09.90; red



**Item No.: 216-203**

Ferrule; Sleeve for 1 mm<sup>2</sup> / AWG 18; insulated; electro-tin plated; red



**Item No.: 216-103**

Ferrule; Sleeve for 1 mm<sup>2</sup> / AWG 18; un-insulated; electro-tin plated



**Item No.: 216-143**

Ferrule; Sleeve for 1 mm<sup>2</sup> / AWG 18; un-insulated; electro-tin plated; electrolytic copper; gastight crimped; acc. to DIN 46228, Part 1/08.92



**Item No.: 216-204**

Ferrule; Sleeve for 1.5 mm<sup>2</sup> / AWG 16; insulated; electro-tin plated; black



**Item No.: 216-244**

Ferrule; Sleeve for 1.5 mm<sup>2</sup> / AWG 16; insulated; electro-tin plated; electrolytic copper; gastight crimped; acc. to DIN 46228, Part 4/09.90; black



**Item No.: 216-264**

Ferrule; Sleeve for 1.5 mm<sup>2</sup> / AWG 16; insulated; electro-tin plated; electrolytic copper; gastight crimped; acc. to DIN 46228, Part 4/09.90; black



**Item No.: 216-284**

Ferrule; Sleeve for 1.5 mm<sup>2</sup> / AWG 16; insulated; electro-tin plated; electrolytic copper; gastight crimped; acc. to DIN 46228, Part 4/09.90; black



**Item No.: 216-144**

Ferrule; Sleeve for 1.5 mm<sup>2</sup> / AWG 16; un-insulated; electro-tin plated; electrolytic copper; gastight crimped; acc. to DIN 46228, Part 1/08.92; silver-colored



**Item No.: 216-104**

Ferrule; Sleeve for 1.5 mm<sup>2</sup> / AWG 16; un-insulated; electro-tin plated; silver-colored



**Item No.: 216-106**

Ferrule; Sleeve for 2.5 mm<sup>2</sup> / AWG 14; un-insulated; electro-tin plated; silver-colored

## 1.2.4 Insulation stop

### 1.2.4.1 Insulation stop



**Item No.: 231-670**

Insulation stop; 0.08-0.2 mm<sup>2</sup> / 0.2 mm<sup>2</sup> "s"; white



**Item No.: 231-671**

Insulation stop; 0.25 - 0.5 mm<sup>2</sup>; light gray



**Item No.: 231-672**

Insulation stop; 0.75 - 1 mm<sup>2</sup>; dark gray

## 1.2.5 Jumper

### 1.2.5.1 Jumper



**Item No.: 231-902**

Jumper; for conductor entry; 2-way; insulated; gray



**Item No.: 231-903**

Jumper; for conductor entry; 3-way; insulated; gray

## 1.2.6 Marking

### 1.2.6.1 Marking strip



**Item No.: 210-833**

Marking strips; 25 m on roll; 6 mm wide; plain; Self-adhesive; white



**Item No.: 210-834**

Marking strips; on reel; 5 mm wide; plain; Self-adhesive; white

## 1.2.7 Strain relief

### 1.2.7.1 Strain relief housing



**Item No.: 232-603**

Strain relief housing; for female and male connectors; 2 parts; Pin spacing 5 mm; 3-pole; gray

## 1.2.8 Tool

### 1.2.8.1 Operating tool



**Item No.: 231-231**

Combination operating tool; red



**Item No.: 210-720**

Operating tool; Blade: 3.5 x 0.5 mm; with a partially insulated shaft; multicoloured



**Item No.: 210-657**

Operating tool; Blade: 3.5 x 0.5 mm; with a partially insulated shaft; short; multicoloured



**Item No.: 209-130**

Operating tool; made of insulating material; 1-way; for 264 Series (1-/2-way), 280, 281 Series (up to 3-way); natural



**Item No.: 231-291**

Operating tool; made of insulating material; 1-way; loose; red



**Item No.: 231-131**

Operating tool; made of insulating material; 1-way; loose; white



**Item No.: 280-432**

Operating tool; made of insulating material; 2-way; white



**Item No.: 280-433**

Operating tool; made of insulating material; 3-way; white



**Item No.: 231-159**

Operating tool; natural

## Installation Notes

### Conductor termination

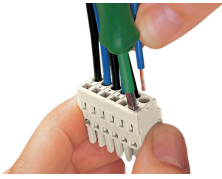

Inserting a conductor via 3.5 mm screwdriver – CAGE CLAMP® actuation parallel to conductor entry.

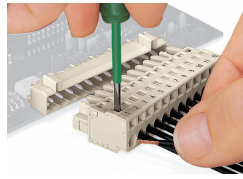

Inserting a conductor via 3.5 mm screwdriver – CAGE CLAMP® actuation perpendicular to conductor entry.

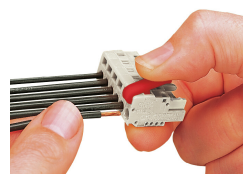

Inserting a conductor via operating tool.

### Testing

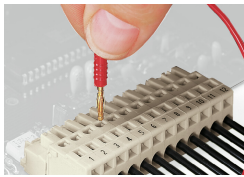

Testing perpendicular to conductor entry with 2 or 2.3 mm Ø test plug – female connector with CAGE CLAMP® – via integrated test ports

### Installation



Male connector with strain relief plate



Strain relief housing shown with a male connector equipped with CAGE CLAMP®

### Coding

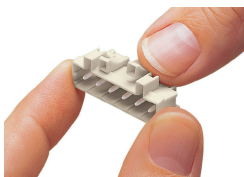

Coding a male header – fitting coding key (s).