

Productinformatieblad

Specificaties



Enkelvoudig contactblok, Harmony XB4, Hamony XB5, zilverlegering, compacte Push-in , 1 NC

ZBE1025

EAN Code: 3389119037433

Prijs: 5,68 EUR

Hoofd

range of product	Harmony XB5 Harmony XB4
product or component type	Contactblok
device short name	ZBE
verkoop per ondeelbare hoeveelheid	5
IP beschermingsgraad	IP20 In overeenstemming met IEC 60529
werking contacten	Slow-break
type contactblok	Enkelvoudig
contact gebruik	Standaardcontacten
aansluitingen - aansluitklemmen	Insteek, $\leq 2 \times 1,5 \text{ mm}^2$ met kabeluiteinde met aansluitflensbus In overeenstemming met IEC 60947-1 Insteek, $\geq 1 \times 0,34 \text{ mm}^2$ zonder draadeinddop In overeenstemming met IEC 60947-1

Complementair

CAD totale breedte	34,3 mm
CAD totale hoogte	14,8 mm
CAD totale diepte	9,8 mm
net weight	0,005 kg
type en samenstelling contact	1 NC
positieve opening	Met In overeenstemming met IEC 60947-5-1 appendix K
bedrijfstraject	1,217 mm (normaal gesloten elektrische status wijzigen) 4,3 mm (totale reis)
bedieningskracht	2,25 N normaal gesloten elektrische status wijzigen
mechanical durability	10000000 cycles
contact materiaal	Zilverlegering (Ag/Ni)
kortsluitbeveiliging	10 A smeltpatroon type gG In overeenstemming met IEC 60947-5-1
lth conventionele thermische stroom in vrije lucht	10 A In overeenstemming met IEC 60947-5-1
Ui nom isolatiespanning	300 V (vervuilingsgraad) 3) In overeenstemming met IEC 60947-1
Uimp nom. schokgolfspanning	4 kV In overeenstemming met IEC 60947-1
le nom. bedrijfstrom	6 A om 120 V, AC-15, A300 In overeenstemming met IEC 60947-5-1 3 A om 240 V, AC-15, A300 In overeenstemming met IEC 60947-5-1 0,55 A om 125 V, DC-13, Q300 In overeenstemming met IEC 60947-5-1 0,27 A om 250 V, DC-13, Q300 In overeenstemming met IEC 60947-5-1

De weergegeven prijs is de adviesprijs in euro excl. BTW. Deze kan onderhevig zijn aan korting. Neem contact op met uw lokale distributeur of detailhandel voor de daadwerkelijke prijs

blokmontage	Vooraan gemonteerd
product presentatie	Basisonderdeel

Omgeving

beschermende behandeling	TH
ambient air temperature for storage	-40...70 °C
ambient air temperature for operation	-40...70 °C
standards	IEC 60947-1 IEC 60947-5-1 IEC 60947-5-4 IEC 60947-5-5 UL 60947-1 UL 60947-5-1 UL 60947-5-5 UL 1059 UL 486E CSA C22.2 Nr 60947-1 CSA C22.2 Nr 60947-5-1 CSA C22.2 Nr. 158 CSA C22.2 Nr 65 IACS E10
product certifications	EAC ECEE CB-regeling CCC UL CSA
trilling bestendigheid	5 gn ($f= 10...500$ Hz) In overeenstemming met IEC 60068-2-6 25 mm piek-piek ($f= 2...10$ Hz) In overeenstemming met IEC 60068-2-6
schokbestendigheid	25 gn (duur = 6 ms) voor 1000 schokken op elke as In overeenstemming met IEC 60068-2-27 30 gn (duur = 18 ms) voor halve sinusgolf versnelling In overeenstemming met IEC 60068-2-27 50 gn (duur = 11 ms) voor halve sinusgolf versnelling In overeenstemming met IEC 60068-2-27

Verpakkingseenheid

Unit Type of Package 1	PCE
Number of Units in Package 1	1
Package 1 Height	1,000 cm
Package 1 Width	1,900 cm
Package 1 Length	3,500 cm
Package 1 Weight	5,000 g
Unit Type of Package 2	BB1
Number of Units in Package 2	5
Package 2 Height	3,400 cm
Package 2 Width	4,500 cm
Package 2 Length	5,300 cm
Package 2 Weight	32,000 g
Unit Type of Package 3	S02
Number of Units in Package 3	500
Package 3 Height	15,000 cm
Package 3 Width	30,000 cm

Package 3 Length 40,000 cm

Package 3 Weight 3,406 kg

contractuele waarborg

Garantie 18 months

Environmental Data

Schneider Electric wil tegen 2050 de Net Zero-status hebben bereikt via partnerschappen in de toeleveringsketen, materialen met een lagere impact en circulariteit via onze doorlopende campagne "Use Better, Use Longer, Use Again" om de levensduur van producten en de recycleerbaarheid te verlengen.

[Uitleg van Environmental Data](#) >

[Hoe evalueren we de duurzaamheid van producten?](#) >

Milieuoetafdruk

Totale levenscyclus ecologische voetafdruk 1

Milieuprofiel van product (PEP) [Milieuprofiel van het product](#)

Use Better

Materialen en verpakking

Pakket met gerecycleerd karton Ja

Verpakkingen zonder kunststof Ja

[EU-richtlijn RoHS](#)

Voldoet pro-actief (Product valt niet onder de EU RoHS juridische scope)

REACH-regelgeving

[REACH-verklaring](#)

Use Again

Herverpakken en herfabriceren

Circulair Profiel [Informatie over einde levensduur](#)

Terugname Ja

WEEE Label



Het product moet op markten van de Europese Unie worden afgevoerd volgens specifieke afvalinzamelingsregels en mag nooit in een gewone vuilnisbak terechtkomen.

Dimensions Drawings

Dimensions

with ZB5AZ009 Fixing Collar

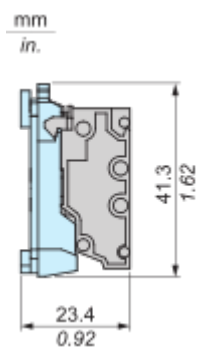

with ZB4BZ009 Fixing Collar

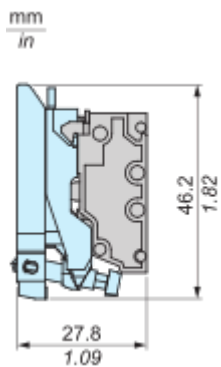

Mounting and Clearance

Mounting

Mounting and Unmounting



Panel cut-out Dimension

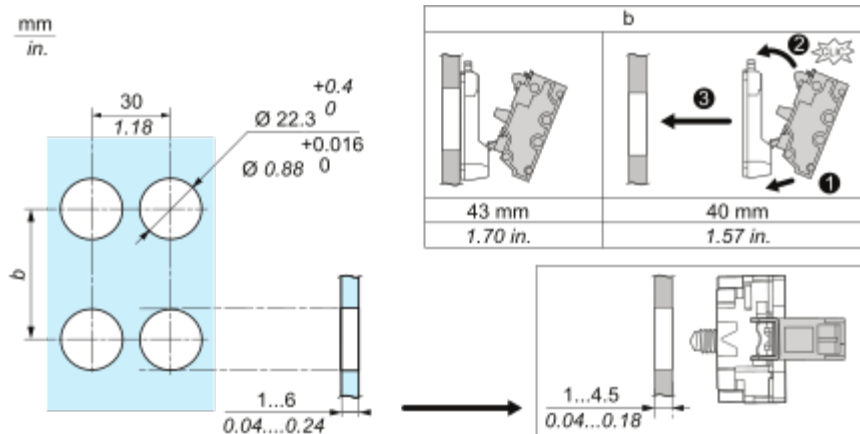

Connections and Schema

Wiring

Wiring and Unwiring

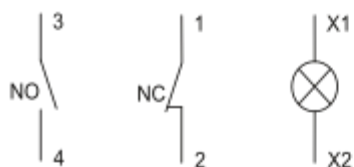

mm	8
in.	0.32
mm ²	0.34...1.5
AWG	22...16

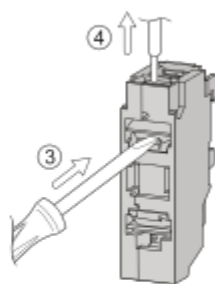
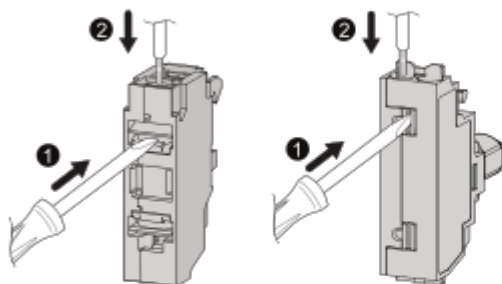
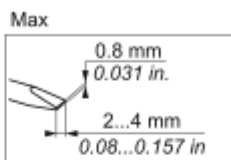

mm	8	8	8
in.	0.32	0.32	0.32
mm ²	0.34...1.5	0.34...1	0.34...1.5
AWG	22...16	22...18	22...16

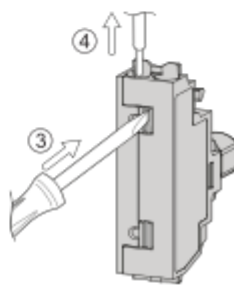
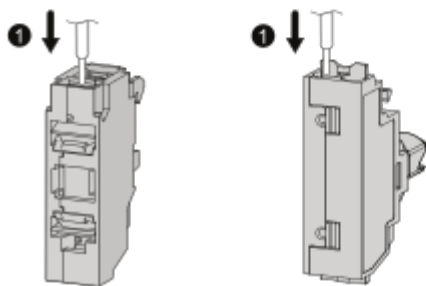

Technical Illustration

Dimensions

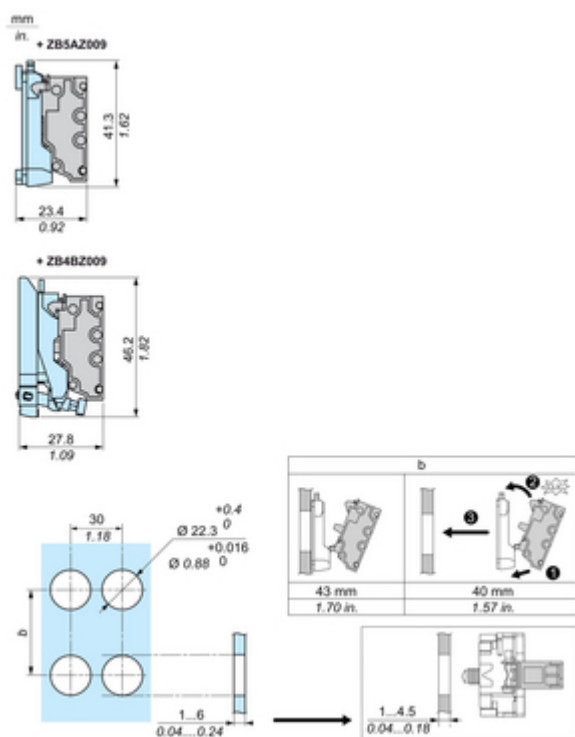

Technical Illustration

Wiring diagram

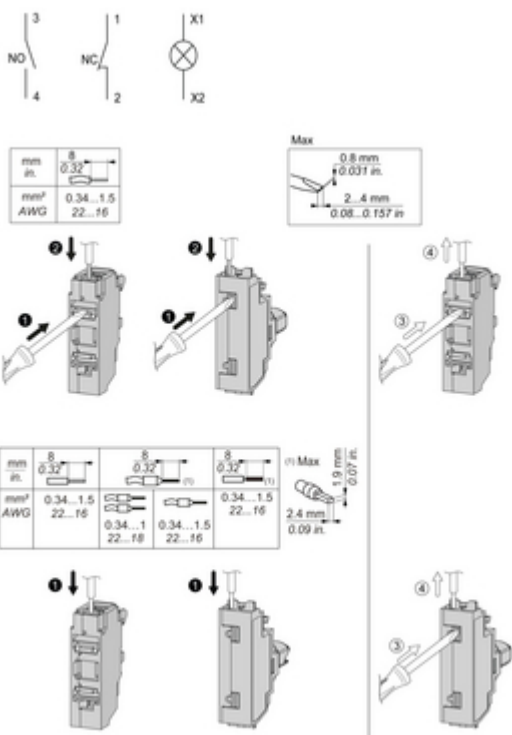

Offer Marketing Illustration

Product benefits / Features

Technical Benefits

Harmony XB4/XB5 Compact Push-in blocks

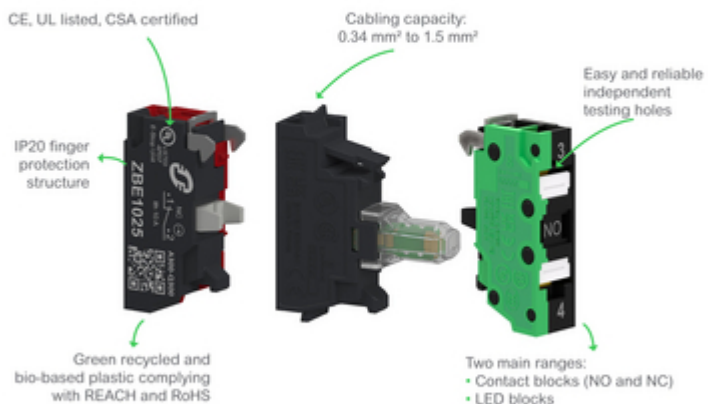

Offer Marketing Illustration

Product benefits / Features

Features
Harmony XB4/XB5 Compact Push-in blocks



37% thinner than a standard block

Installation costs saved through reduced wiring time and effort

Fully compatible with current Harmony offer





Available as single block, sub-assemblies and complete units (both plastic and metal ranges)

Simplified inventory management

Offer Marketing Illustration

Product benefits / Features

Features
Harmony XB4

-  Quick and easy assembly and disassembly
-  Excellent mechanical connection with operator head
-  Various types of connection: screw clamp, connector, Faston connector, spring terminal, or printed circuit board
-  Large set of accessories to customize your panels
-  Robustness to withstand harsh environments

Offer Marketing Illustration

Product benefits / Features

Technical Benefits

Harmony XB4

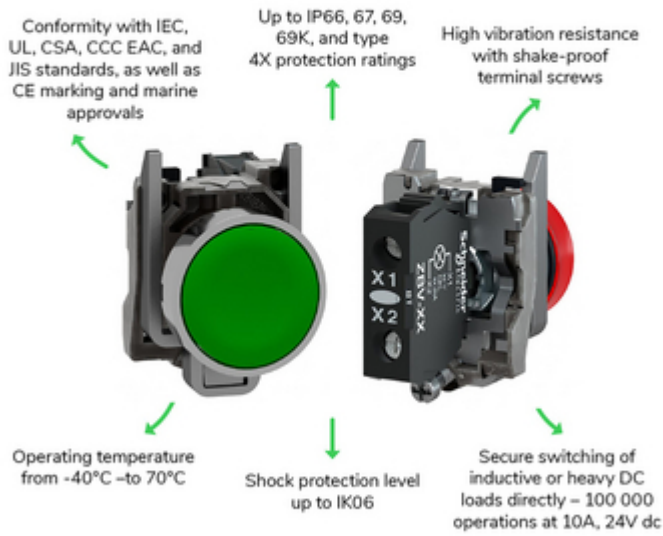

Image of product / Alternate images

Alternative





