

Dispenser free-standing model - Chrome















SERIES SPECIFIC

84 435 970 Product version from 10/1/2023



- bottle made of crystal glass, matt
- width 60mm
- height 200 mm
- 250 ml bottle
- 59mm projection

Fits ELIO, ENO, MEM, META SQUARE, SYNC, TARA and TARA ULTRA

	Chrome	84 435 970-00
	Brushed Platinum	84 435 970-06
	Platinum	84 435 970-08
	Dark Chrome	84 435 970-19
	Brushed Durabrass (23kt Gold)	84 435 970-28
	Matte Black	84 435 970-33
	Brushed Gold (PVD)	84 435 970-37
	Brushed Dark Brass (PVD)	84 435 970-39
	Brushed Bronze (PVD)	84 435 970-42
	Brushed Dark Bronze (PVD)	84 435 970-43
	Brushed Champagne (22kt Gold)	84 435 970-46
	Champagne (22kt Gold)	84 435 970-47
	Brushed Chrome	84 435 970-93
	Brushed Dark Platinum	84 435 970-99

84 435 970 Product version from 10/1/2023

mm [inches]

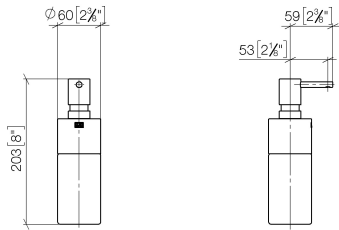

84 435 970 Product version from 10/1/2023

Parts for other finishes can be found here: Brushed Platinum

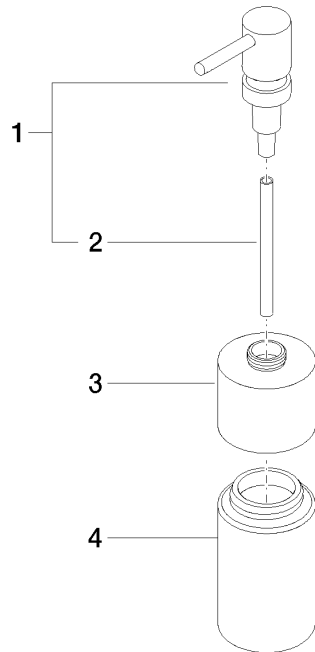

Spare parts list

No.	Item Number	Name	Quantity used	Delivery time
4	90 90 04 001 00 82	Bottle for lotion dispenser -	1.00	14
2	08 10 10 499 90	Immersion tube for lotion dispenser Ø 8 x 1 x 100 mm -	1.00	14
3	90 10 10 524 00-00	Dispenser Retainer, deck-mounting Ø 60 x 49 mm - Chrome	1.00	20
1	90 10 10 535 00-00	Lotion dispenser - Chrome	1.00	20