

Panel mounted receptacle

Part number: 623

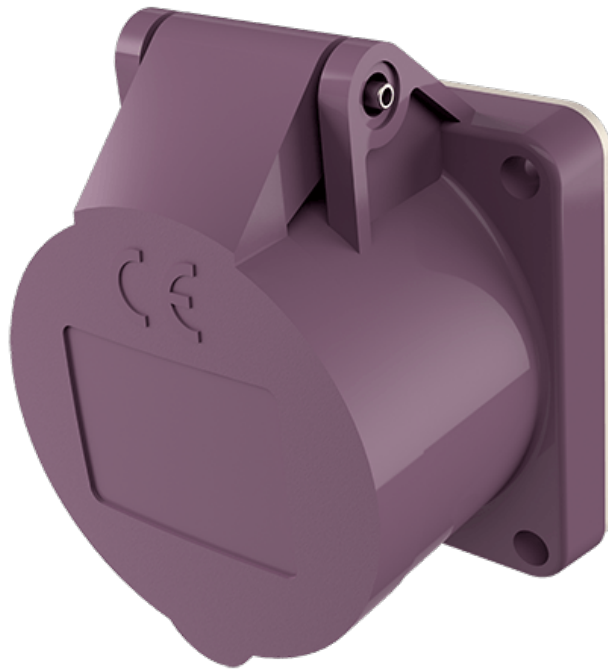

MENNEKES
Elektrotechnik GmbH & Co. KG

Aloys-Mennekes-Straße 1
57399 Kirchhundem
GERMANY

www.MENNEKES.org

Product Description

- screw connection technology
- straight insertion direction

Technical Details

Panel mounted receptacle	623
Ampere	32A
Number of poles	3p
Nominal voltage AC	20 - 25V
Nominal frequency	50 - 60 Hz
Protection type IP	IP44
Contact carrier	standard
X-CONTACT	no
Connection	screw terminals
Contact screw drive	PZ2, slot
Pilot contact	without pilot contact
Pilot contact switch	no
Flange dimensions	55 x 55 mm
Hole spacings	45 x 45 mm
Insertion direction	straight
Highly resistant to chemicals	no
Military version	no
Tightening torque connection terminal for cable cross-section 1,0 - 1,5 mm ²	0.6 Nm
Tightening torque connection terminal for cable cross-section 2,5 - 4,0 mm ²	0.8 Nm
Tightening torque connection terminal for cable cross-section 6 - 10 mm ²	1.2 Nm
Strip length flexible conductor	12 - 17 mm
Strip length solid conductor	12 - 17 mm
Conductor cross-section min.	4 mm ²
Conductor cross-section max.	10 mm ²
Weight (net)	130 g

Panel mounted receptacle	623
Packaging unit	10 pcs
Quantity per pallet	2080 pcs
EAN / identification number	4015394004677

Permissible ambient conditions

	Min.	Max.
Permissible ambient temperature	-25 °C	40 °C
Average temperature over 24 hours		35 °C

Material properties

Housing	PA6 purple [similar RAL 4001]
Hinged lid	PA6 purple [similar RAL 4001]

Material resistance

The material resistance overview can be found on the website in the section “Knowledge” - “Product knowledge” - “Materials”.

Material and environmental properties

RoHS 2011/65/EU incl. 2015/863/EU	✓
POP regulation (EU) 2019/1021	✓
Halogen-free	yes

Regulations and Standards

Norm	DIN EN IEC 60309-2
Declaration of Conformity	CE
Test label	EAC

Dimensional Drawing

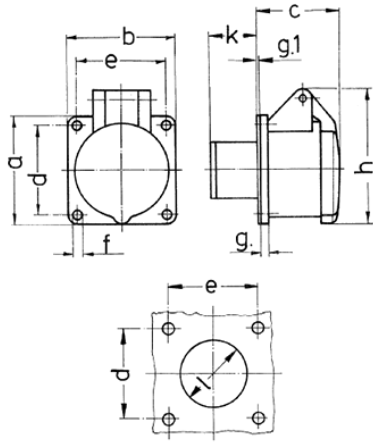

Drawing 1 MB 136	Amp. Poles	16		32	
		2	3	2	3
Dim. in mm	a	55	55	55	55
	b	55	55	55	55
	c	44	44	44	44
	d	45	45	45	45
	e	45	45	45	45
	f	4.2	4.2	4.2	4.2
	g.	8	8	8	8
	g.1	2	2	2	2
	h	67	67	67	67
	k	22	22	22	22
	l	34	34	34	34
Terminal for cond. cross section (mm ²) min.-max.		4	4	4	4
		-10	-10	-10	-10