

Data Sheet | Item Number: 231-307/027-000

1-conductor female connector; CAGE CLAMP®; 2.5 mm²; Pin spacing 5.08 mm; 7-pole; clamping collar; orange

<https://www.wago.com/231-307/027-000>



Color: ■ orange

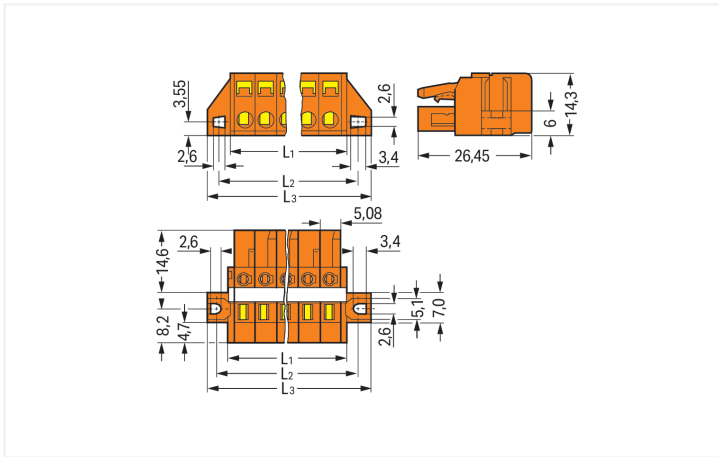

Dimensions in mm

$L1 = (\text{pole no.} \times \text{pin spacing}) + 3 \text{ mm}$
 $L2 = (\text{pole no.} \times \text{pin spacing}) + 8.8 \text{ mm}$
 $L3 = (\text{pole no.} \times \text{pin spacing}) + 14.8 \text{ mm}$ - to 3-pole female connectors – one latch only

Female connector, 231 Series, orange

Our female connector (item number 231-307/027-000) ensures effortless electrical installations. Strip lengths must be between 8 and 9 mm when connecting conductors to this female connector. This product features one conductor terminal and utilizes CAGE CLAMP®. Our tried-and-tested universal connection known as CAGE CLAMP® is the industry standard for connection technology and electrical interconnections. Dimensions: (50.36 x 14.3 x 26.45) mm (width x height x depth). Depending on the conductor type, this female connector is designed for conductor cross sections ranging from 0.08 mm² to 2.5 mm². Tin is used for coating the contact surfaces.

Notes

Safety Information

The MCS – MULTI CONNECTION SYSTEM includes connectors without breaking capacity in accordance with DIN EN 61984. When used as intended, these connectors must not be connected/disconnected when live or under load. When used as intended, these connectors must not be connected/disconnected when live or under load. The circuit design should ensure header pins, which can be touched, are not live when unmated.

Variants:

Gold-plated or partially gold-plated contact surfaces
Other versions (or variants) can be requested from WAGO Sales or configured at <https://configurator.wago.com/>.

Electrical data

| Ratings per | IEC/EN 60664-1 | | |
|---------------------------------|----------------|-------|-------|
| Overvoltage category | III | III | II |
| Pollution degree | 3 | 2 | 2 |
| Nominal voltage | 320 V | 320 V | 630 V |
| Rated impulse withstand voltage | 4 kV | 4 kV | 4 kV |
| Rated current | 16 A | 16 A | 16 A |

| Approvals per | UL 1059 | | |
|---------------|---------|---|-------|
| Use group | B | C | D |
| Rated voltage | 300 V | - | 300 V |
| Rated current | 15 A | - | 10 A |

| Approvals per | UL 1977 |
|---------------|---------|
| Rated voltage | 600 V |
| Rated current | 15 A |

| Approvals per | CSA | | |
|---------------|-------|---|-------|
| Use group | B | C | D |
| Rated voltage | 300 V | - | 300 V |
| Rated current | 15 A | - | 10 A |

Connection Data

| | |
|----------------------------|---|
| Clamping units | 7 |
| Total number of potentials | 7 |
| Number of connection types | 1 |
| Number of levels | 1 |

Connection 1

| | |
|---|--|
| Connection technology | CAGE CLAMP® |
| Actuation type | Operating tool |
| Actuation direction 1 | Operation parallel to conductor entry |
| Actuation direction 2 | Operation perpendicular to conductor entry |
| Solid conductor | 0.08 ... 2.5 mm ² / 28 ... 12 AWG |
| Fine-stranded conductor | 0.08 ... 2.5 mm ² / 28 ... 12 AWG |
| Fine-stranded conductor; with insulated ferrule | 0.25 ... 1.5 mm ² |
| Fine-stranded conductor; with uninsulated ferrule | 0.25 ... 2.5 mm ² |
| Strip length | 8 ... 9 mm / 0.31 ... 0.35 inches |
| Pole number | 7 |
| Conductor entry direction to mating direction | 0° |

Physical data

| | |
|-------------|-------------------------|
| Pin spacing | 5.08 mm / 0.2 inches |
| Width | 50.36 mm / 1.983 inches |
| Height | 14.3 mm / 0.563 inches |
| Depth | 26.45 mm / 1.041 inches |

Mechanical data

| | |
|---|---|
| Variable coding | Yes |
| Mounting type | Mounting flange |
| Mounting type | Feed-through mounting Panel mounting |
| with reinforcing strips | 1 |
| Anti-rotation protection | Yes |
| Suitable for through-panel applications | Yes |

Plug-in connection

| | |
|------------------------------------|-------------------------|
| Contact type (pluggable connector) | Female connector/socket |
| Connector (connection type) | for conductor |
| Mismating protection | No |

Material data

| | |
|------------------------------------|--|
| Note (material data) | Information on material specifications can be found here |
| Color | orange |
| Material group | I |
| Insulation material (main housing) | Polyamide (PA66) |
| Flammability class per UL94 | V0 |
| Clamping spring material | Chrome-nickel spring steel (CrNi) |
| Contact material | Copper alloy |
| Contact Plating | Tin |
| Fire load | 0.209 MJ |
| Weight | 13.7 g |

Environmental requirements

| | | |
|-------------------------|-----------------|---|
| Limit temperature range | -60 ... +100 °C | <h4>Environmental Testing</h4> |
| Processing temperature | -35 ... +60 °C | |
| | | Test specification: Railway applications – Rolling stock – Electronic equipment |
| | | DIN EN 50155 (VDE 0115-200):2022-06 |
| | | Test procedure: Railway applications – Rolling stock equipment – Vibration and shock tests |
| | | DIN EN 61373 (VDE 0115-0106):2011-04 |
| | | Spectrum/Mounting location |
| | | Service life test, Category 1, Class A/B |
| | | Functional test with noise-like oscillations |
| | | Test passed according to Section 8 of the standard |
| | | Frequency |
| | | $f_1 = 5 \text{ Hz}$ to $f_2 = 150 \text{ Hz}$ |
| | | Acceleration |
| | | 0.101g (highest test level used for all axes) |
| | | Test duration per axis |
| | | 10 min. |
| | | Test directions |
| | | X, Y and Z axes |
| | | Monitoring of contact faults and interruptions |
| | | Passed |
| | | Voltage drop measurement before and after each axis |
| | | Passed |
| | | Simulated service life test through increased levels of noise-like oscillations |
| | | Test passed according to Section 9 of the standard |
| | | Frequency |
| | | $f_1 = 5 \text{ Hz}$ to $f_2 = 150 \text{ Hz}$ |
| | | Acceleration |
| | | 0.572g (highest test level used for all axes) |
| | | Test duration per axis |
| | | 5 h |
| | | Test directions |
| | | X, Y and Z axes |
| | | Extended testing: Monitoring of contact faults and interruptions |
| | | Passed |

Environmental Testing

| | |
|---|---|
| Extended testing: Voltage drop measurement before and after each axis | Passed |
| Shock test | Test passed according to Section 10 of the standard |
| Shock pulse form | Half sine |
| Acceleration | 5g (highest test level used for all axes) |
| Shock duration | 30 ms |
| Number of shocks (per axis) | 3 pos. und 3 neg. |
| Test directions | X, Y and Z axes |
| Extended testing: Monitoring of contact faults and interruptions | Passed |
| Extended testing: Voltage drop measurement before and after each axis | Passed |
| Vibration and shock stress for rolling stock equipment | Passed |

Commercial data

| | |
|-----------------------|------------------------|
| Product Group | 3 (Multi Conn. System) |
| PU (SPU) | 50 pcs |
| Packaging type | Box |
| Country of origin | DE |
| GTIN | 4044918347129 |
| Customs tariff number | 85366990990 |

Product Classification

| | |
|-------------|----------------------|
| UNSPSC | 39121409 |
| eCl@ss 10.0 | 27-44-03-09 |
| eCl@ss 9.0 | 27-44-03-09 |
| ETIM 9.0 | EC002638 |
| ETIM 10.0 | EC002638 |
| ECCN | NO US CLASSIFICATION |

Environmental Product Compliance

| | |
|------------------------|-------------------------|
| RoHS Compliance Status | Compliant, No Exemption |
|------------------------|-------------------------|

Approvals / Certificates

General approvals



| Approval | Standard | Certificate Name |
|---------------------------------------|----------|------------------|
| CSA DEKRA Certification B.V. | C22.2 | 1466354 |
| KEMA/KEUR DEKRA Certification B.V. | EN 61984 | 71-130478 REV.1 |
| UL UL International Germany GmbH | UL 1977 | E45171 |
| UR Underwriters Laboratories Inc. | UL 1059 | E45172 |

Declarations of conformity and manufacturer's declarations



| Approval | Standard | Certificate Name |
|-------------------------------|----------|------------------|
| Railway WAGO GmbH & Co. KG | - | Railway Ready |

Approvals for marine applications



| Approval | Standard | Certificate Name |
|---|----------|------------------|
| ABS American Bureau of Ship- ping | - | 24-0095975-PDA |

Downloads

Environmental Product Compliance

| Compliance Search |
|--|
| Environmental Product Compliance 231-307/027-000 |

Documentation

| Additional Information | | | |
|------------------------|------------|-------------------|--|
| Technical Section | 03.04.2019 | pdf 2027.26 KB | |

CAD/CAE-Data

| CAD data |
|---------------------------------|
| 2D/3D Models 231-307/027-000 |

| CAE data |
|--------------------------------------|
| EPLAN Data Portal 231-307/027-000 |

| |
|---------------------------------|
| ZUKEN Portal 231-307/027-000 |
|---------------------------------|

1 Compatible Products

1.1 System counterpart

1.1.1 Male connector/plug



Item No.: 231-637
1-conductor male connector; CAGE
CLAMP®; 2.5 mm²; Pin spacing 5.08 mm;
7-pole; orange

Item No.: 231-537/001-000
THT male header; 1.0 x 1.0 mm solder pin;
angled; Pin spacing 5.08 mm; 7-pole;
orange

Item No.: 231-337/001-000
THT male header; 1.0 x 1.0 mm solder pin;
straight; Pin spacing 5.08 mm; 7-pole;
orange

1.2 Optional Accessories

1.2.1 Cover

1.2.1.1 Cover



Item No.: 231-669

Lockout caps; for covering unused clamping units; orange

1.2.2 Ferrule

1.2.2.1 Ferrule



Item No.: 216-301

Ferrule; Sleeve for 0.25 mm² / AWG 24; insulated; electro-tin plated; yellow



Item No.: 216-302

Ferrule; Sleeve for 0.34 mm² / 22 AWG; insulated; electro-tin plated; light turquoise



Item No.: 216-201

Ferrule; Sleeve for 0.5 mm² / 20 AWG; insulated; electro-tin plated; electrolytic copper; acc. to DIN 46228, Part 4/09.90; white



Item No.: 216-241

Ferrule; Sleeve for 0.5 mm² / 20 AWG; insulated; electro-tin plated; electrolytic copper; gastight crimped; acc. to DIN 46228, Part 4/09.90; white



Item No.: 216-141

Ferrule; Sleeve for 0.5 mm² / 20 AWG; un-insulated; electro-tin plated; electrolytic copper; gastight crimped; acc. to DIN 46228, Part 1/08.92



Item No.: 216-101

Ferrule; Sleeve for 0.5 mm² / AWG 22; un-insulated; electro-tin plated; silver-colored



Item No.: 216-242

Ferrule; Sleeve for 0.75 mm² / 18 AWG; insulated; electro-tin plated; electrolytic copper; gastight crimped; acc. to DIN 46228, Part 4/09.90; gray



Item No.: 216-262

Ferrule; Sleeve for 0.75 mm² / 18 AWG; insulated; electro-tin plated; electrolytic copper; gastight crimped; acc. to DIN 46228, Part 4/09.90; gray



Item No.: 216-202

Ferrule; Sleeve for 0.75 mm² / 18 AWG; insulated; electro-tin plated; gray



Item No.: 216-142

Ferrule; Sleeve for 0.75 mm² / 18 AWG; un-insulated; electro-tin plated; electrolytic copper; gastight crimped; acc. to DIN 46228, Part 1/08.92



Item No.: 216-102

Ferrule; Sleeve for 0.75 mm² / AWG 20; un-insulated; electro-tin plated; silver-colored



Item No.: 216-243

Ferrule; Sleeve for 1 mm² / AWG 18; insulated; electro-tin plated; electrolytic copper; gastight crimped; acc. to DIN 46228, Part 4/09.90; red



Item No.: 216-263

Ferrule; Sleeve for 1 mm² / AWG 18; insulated; electro-tin plated; electrolytic copper; gastight crimped; acc. to DIN 46228, Part 4/09.90; red



Item No.: 216-203

Ferrule; Sleeve for 1 mm² / AWG 18; insulated; electro-tin plated; red



Item No.: 216-103

Ferrule; Sleeve for 1 mm² / AWG 18; un-insulated; electro-tin plated



Item No.: 216-143

Ferrule; Sleeve for 1 mm² / AWG 18; un-insulated; electro-tin plated; electrolytic copper; gastight crimped; acc. to DIN 46228, Part 1/08.92



Item No.: 216-204

Ferrule; Sleeve for 1.5 mm² / AWG 16; insulated; electro-tin plated; black



Item No.: 216-244

Ferrule; Sleeve for 1.5 mm² / AWG 16; insulated; electro-tin plated; electrolytic copper; gastight crimped; acc. to DIN 46228, Part 4/09.90; black



Item No.: 216-264

Ferrule; Sleeve for 1.5 mm² / AWG 16; insulated; electro-tin plated; electrolytic copper; gastight crimped; acc. to DIN 46228, Part 4/09.90; black



Item No.: 216-284

Ferrule; Sleeve for 1.5 mm² / AWG 16; insulated; electro-tin plated; electrolytic copper; gastight crimped; acc. to DIN 46228, Part 4/09.90; black



Item No.: 216-144

Ferrule; Sleeve for 1.5 mm² / AWG 16; un-insulated; electro-tin plated; electrolytic copper; gastight crimped; acc. to DIN 46228, Part 1/08.92; silver-colored



Item No.: 216-104

Ferrule; Sleeve for 1.5 mm² / AWG 16; un-insulated; electro-tin plated; silver-colored



Item No.: 216-106

Ferrule; Sleeve for 2.5 mm² / AWG 14; un-insulated; electro-tin plated; silver-colored

1.2.3 Insulation stop

1.2.3.1 Insulation stop



Item No.: 231-670

Insulation stop; 0.08-0.2 mm² / 0.2 mm² "s"; white



Item No.: 231-671

Insulation stop; 0.25 - 0.5 mm²; light gray



Item No.: 231-672

Insulation stop; 0.75 - 1 mm²; dark gray

1.2.4 Jumper

1.2.4.1 Jumper



Item No.: 231-902

Jumper; for conductor entry; 2-way; insulated; gray



Item No.: 231-903

Jumper; for conductor entry; 3-way; insulated; gray



Item No.: 231-905

Jumper; for conductor entry; 5-way; insulated; gray



Item No.: 231-907

Jumper; for conductor entry; 7-way; insulated; gray

1.2.5 Marking

1.2.5.1 Marking strip



Item No.: 210-331/508-103

Marking strips; as a DIN A4 sheet; MARKED; 1-12 (200x); Height of marker strip: 2.3 mm/0.091 in; Strip length 182 mm; Horizontal marking; Self-adhesive; white



Item No.: 210-332/508-202

Marking strips; as a DIN A4 sheet; MARKED; 1-16 (160x); Height of marker strip: 3 mm; Strip length 182 mm; Horizontal marking; Self-adhesive; white



Item No.: 210-332/508-205

Marking strips; as a DIN A4 sheet; MARKED; 1-32 (80x); Height of marker strip: 3 mm; Strip length 182 mm; Horizontal marking; Self-adhesive; white



Item No.: 210-331/508-104

Marking strips; as a DIN A4 sheet; MARKED; 13-24 (200x); Height of marker strip: 2.3 mm/0.091 in; Strip length 182 mm; Horizontal marking; Self-adhesive; white



Item No.: 210-332/508-204

Marking strips; as a DIN A4 sheet; MARKED; 17-32 (160x); Height of marker strip: 3 mm; Strip length 182 mm; Horizontal marking; Self-adhesive; white



Item No.: 210-332/508-206

Marking strips; as a DIN A4 sheet; MARKED; 33-48 (160x); Height of marker strip: 3 mm; Strip length 182 mm; Horizontal marking; Self-adhesive; white

1.2.6 Strain relief

1.2.6.1 Strain relief housing



Item No.: 232-637

Strain relief housing; for female and male connectors; 2 parts; Pin spacing 5.08 mm; 7-pole; orange

1.2.7 Test and measurement

1.2.7.1 Testing accessories



Item No.: 210-136

Test plug; 2 mm Ø; with 500 mm cable; red

Item No.: 231-661

Test plugs for female connectors; for 5 mm and 5.08 mm pin spacing; 2,50 mm²; light gray

1.2.8 Tool

1.2.8.1 Operating tool



Item No.: 231-231

Combination operating tool; red



Item No.: 209-132

Operating tool; for connecting comb-style jumper bar; made of insulating material; 2-way; natural



Item No.: 209-130

Operating tool; made of insulating material; 1-way; for 264 Series (1-/2-way), 280, 281 Series (up to 3-way); natural



Item No.: 231-291

Operating tool; made of insulating material; 1-way; loose; red



Item No.: 231-131

Operating tool; made of insulating material; 1-way; loose; white



Item No.: 280-432

Operating tool; made of insulating material; 2-way; white



Item No.: 280-433

Operating tool; made of insulating material; 3-way; white



Item No.: 280-434

Operating tool; made of insulating material; 4-way; white



Item No.: 280-435

Operating tool; made of insulating material; 5-way; gray



Item No.: 280-436

Operating tool; made of insulating material; 6-way; white



Item No.: 280-437

Operating tool; made of insulating material; 7-way; white



Item No.: 231-159

Operating tool; natural

Installation Notes



Female connectors with mounting flanges can be used as PCB through-panel connectors – conductor termination parallel to CAGE CLAMP® actuation.

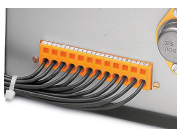

PCB female connectors with mounting flanges can be used as through-panel connectors for external wiring.



16-pole female connector with mounting flanges in a 19" rack – conductor termination parallel to CAGE CLAMP® actuation

Conductor termination

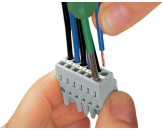

Inserting a conductor via 3.5 mm screwdriver – CAGE CLAMP® actuation parallel to conductor entry.

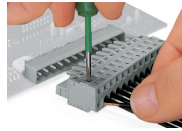

Inserting a conductor via 3.5 mm screwdriver – CAGE CLAMP® actuation perpendicular to conductor entry.

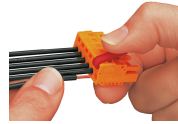

Inserting a conductor into CAGE CLAMP® unit via operating tool (231-291).



Inserting a conductor via operating tool.

Coding



Coding a female connector by removing coding finger(s).

Testing

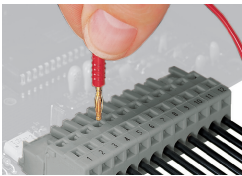

Testing – female connector with CAGE CLAMP®
Integrated test ports for testing perpendicular to conductor entry via 2 or 2.3 mm Ø test plug

Installation

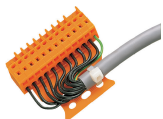

Male connector with strain relief plate



Strain relief housing shown with a male connector equipped with CAGE CLAMP®

Marking

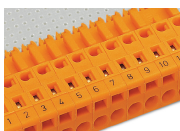

Labeling via direct marking or self-adhesive strips.