

Toestelcontactstop

Bestelnr. 473



- schroefklemmen
- met klapdeksel

Technische informatie

Ampère	32 A
Polen	5 p
Voltage	230 V
Uurstand	9 h
Hertz	50-60 Hz
Aansluittechniek	schroefklemmen
Contacten	standaard
Beschermingsgraad	IP 67
Gewicht	434 g
Certificeringen	EAC

Tekeningen

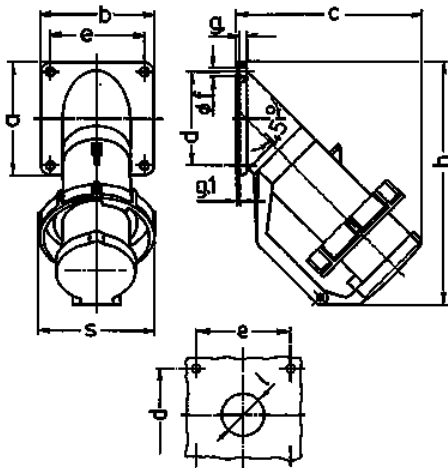

Tekening	Amp. Polen	16		32		63	
		5	3	4	5	4	5
2 MB 40							
Maten in mm							
a		85	85	85	85	114	114
b		85	85	85	85	114	114
c		141	141	141	144	180	180
d		70	70	70	70	90	90
e		70	70	70	70	90	90
f		6,2	6,2	6,2	6,2	6,2	6,2
g		6	6	6	6	6	6
g.1		2	2	2	2	2	2
h		181	181	181	188	242	242
s		86	93	93	100	113	113
l		30	30	30	30	40	40
Kabelaansluiting							
van/tot mm²		1	2,5	2,5	2,5	4	4
		—2,5	—6	—6	—6	—16	—16