

ToLEDo RT Ball V5 CL 250LM 827 E14 SL

Item No: 0029499

SYLVANIA



Perfect for decorative and general lighting applications and creates a warm ambience similar to traditional lamps. The versatile ToLEDo Retro ball range is the ideal replacement for halogen and incandescent lamps and perfect for chandeliers and decorative applications. Same look, size and functionality as incandescent lamps. Omni-directional light distribution. Gives same sparkling light effect as the incandescent lamp. Dimensionally identical to incandescent lamps - fits all fixtures. Environment-friendly - no mercury and lower CO2 emissions.

Technical Assets

Dimensions (mm)

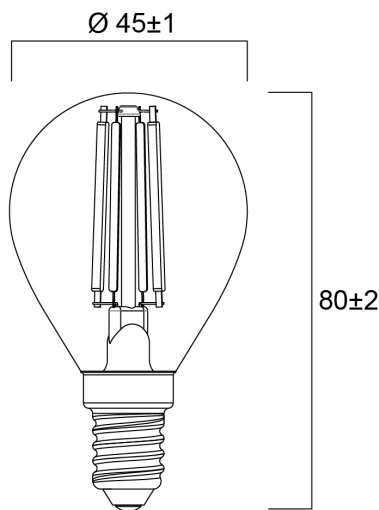

Photometrics

ToLEDo RT Ball V5 CL 250LM 827 E14 SL

Item No: 0029499

SYLVANIA

General data

Product name	ToLEDo RT Ball V5 CL 250LM 827 E14 SL
Technology	LED
Watt (Rated) (W)	2.5
Cap/Base	E14
Fixture rating	Open
General application	Hospitality, Residential & Consumer
Operating temperature range (°C)	-20°C...+40°C
Performance ambient temperature Tq (°C)	25
ETIM Class	EC001959
E-number FI	4740947
Warranty	3 years

Optical data

Useful luminous flux (Φ_{use})	250
Luminous flux (lm)	250
Luminous flux (Rated) (lm)	250
Correlated colour temperature (k)	2700
Light colour	Homelight
CRI (Ra)	80
Colour Variation Initial (SDCM)	SDCM6
Photobiological Risk Group	RG1
Lumen maintenance at end of nominal life (%)	70

Electrical data

Power consumption (W)	2.5
Wattage (W)	2.5
Equivalent watt (W)	25
Primary Supply/Product voltage - min (V)	220
Primary Supply/Product voltage - max (V)	240
Control gear required	No
No. Of switching cycles before premature failures	>50000
Dimmable	No
Inrush Current (A)	5.9
Inrush Duration (μ s)	180
Lamp Energy Label (class)	F
Nominal Frequency (Hz)	50/60Hz
Max. products per 16A C Breaker	27
Max. products per 16A B Breaker	14

Lifetime data

Lifespan L70 B50	15000
Average life (Nominal) (h)	15000
Average life (Rated) (h)	15000

Physical data

Nominal Product Length (mm)	80
Nominal Product Diameter (mm)	45
Weight (kg)	0.014

ToLEDo RT Ball V5 CL 250LM 827 E14 SL

Item No: 0029499

SYLVANIA

Packaging

Product EAN number	5410288294995
Packaging single length / height (cm)	5.0
Packaging single width (cm)	5.0
Packaging single depth (cm)	9.5
DUN14 (inner)	15410288294992
Units per outer package	6
Packaging outer length / height (cm)	15.8
Packaging outer width (cm)	10.7
Packaging outer depth (cm)	10.5

Safety data

Optimal operating condition (°C)	-20-40
Breakage cleaning instructions	Not applicable
Special purpose lamp	No
Dry applications use only	Yes
Suitable for household illumination	Yes
Safety message	Not Suitable for totally enclosed fixtures