







36 860 705 Product version from 7/1/2023



- 198mm projection
- fixed spout
- rectangular spray pattern with 40 individual jets
- hole diameter spout 37 mm
- hole diameter single-lever mixer 57 mm
- rosette 80 x 80 mm
- max. flow 4.5 l/min
- lead-free
- This product can help a building meet the requirements of Green Building Rating Systems, e.g. LEED®, BREEAM®, DGNB

	Chrome	36 860 705-00
	Brushed Platinum	36 860 705-06
	Dark Chrome	36 860 705-19
	Brushed Light Gold (PVD)	36 860 705-27
	Brushed Champagne (22kt Gold)	36 860 705-46
	Champagne (22kt Gold)	36 860 705-47
	Brushed Dark Platinum	36 860 705-99

**Required miscellaneous**



**Concealed wall-mounted single-lever mixer - 35 860 970 90**

- min. recess depth 75 mm
- max. recess depth 95 mm
- mixer can be placed above, to the left or to the right of the spout.

36 860 705 Product version from 7/1/2023

mm [inches]

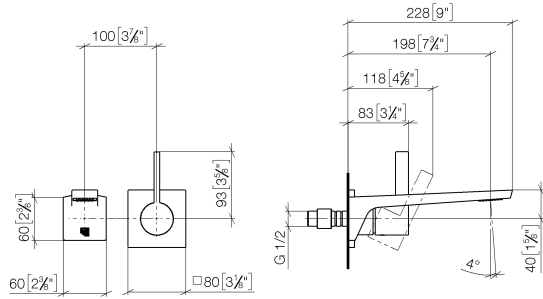

**Flow rate chart**



**Codes & Standards**

ASME A112.18.1      cUPC      DIN 4109      EN 817

EPA WaterSense      ISO 3822      NSF372      NSF61

Ü-Zeichen

WaterSense





## CL.1 Wall-mounted single-lever basin mixer without pop-up waste - Chrome

CL.1

36 860 705 Product version from 7/1/2023

### Certificates and sustainability

---

IAPMO_N-4976	DVGW_DW- 6512DN0	IAPMO_6397	LGA_29	IAPMO_4976 (
IAPMO_8834	EPD-DOR-20230287 -IBA1-EN Environmental.prod uct-declarat			

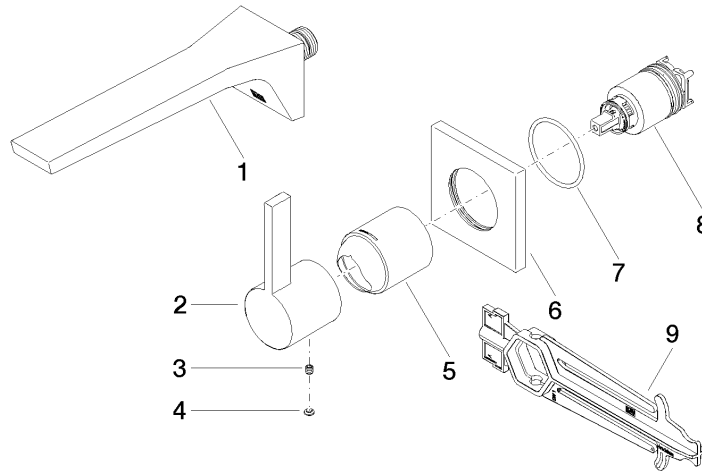

**Spare parts list**

No.	Item Number	Name	Quantity used	Delivery time
	6 09 27 78 039-00	Rosette 80 x 80 x 9 x Ø 45,7 mm - Chrome	1.00	20
	5 09 11 02 288-00	Cover Ø 45 x 55 mm - Chrome	1.00	20
	1 13 800 705-00	CL.1 Wall-mounted basin spout without pop-up waste - Chrome	1.00	14
	9 90 30 09 064 00 90	Spanner for cartridge nut -	1.00	14
	3 90 31 11 030 00 90	Mounting Threaded pin with hexagon socket with cup point M5 x 5 mm -	1.00	14
	4 90 31 20 087 00-00	Plug with O-ring Ø 7 x 2,1 mm - Chrome	1.00	20
	8 90 15 05 064 01 90	Single-lever mixer cartridge with adapter plate incl. installation spanner Ø 35 mm x 58,6 mm -	1.00	-
	Spare part can no longer be ordered, please order the replacement item			
	9015050460190	Single-lever mixer cartridge with cartridge insert , torque wrench Ø 35 mm x 58,6 mm -		
	2 09 20 70 050-00	Handle Lever 85 x 58,5 x 11 mm - Chrome	1.00	20
	7 90 14 10 049 00 90	O-Ring 45,69 x 2,62 mm -	1.00	14