

PRESTATIEVERKLARING

DoP 0327

voor fischer Highbond-Anchor FHB II (Verbonden expansiebevestiging voor gebruik in beton)

NL

1. Unieke identificatiecode van het producttype: **DoP 0327**
2. Beoogd(e) gebruik(en): **Bevestigingen in gescheurd of ongescheurd beton, zie bijlage, met name de bijlagen B1 - B11.**
3. Fabrikant: **fischerwerke GmbH & Co. KG, Otto-Hahn-Straße 15, 79211 Denzlingen, Duitsland**
4. Gemachtigde: **-**
5. Het systeem of de systemen voor de beoordeling en verificatie van de prestatiebestendigheid: **1**
6. Europees beoordelingsdocument: **EAD 330499-01-0601**
Europese technische beoordeling: **ETA-21/0948; 2022-09-09**
Technische beoordelingsinstantie: **DIBt- Deutsches Institut für Bautechnik**
Aangemelde instantie(s): **2873 TU Darmstadt**
7. Aangegeven prestatie(s):
Mechanische weerstand en stabiliteit (BWR 1)
Kenmerkende weerstand tegen trekbelasting (statische en quasi-statische belasting):
Weerstand tegen staalbreuk: Bijlage C1
Weerstand tegen gecombineerd uittrekken en betonnen kegelbreuk: Bijlagen C2-C4
Weerstand tegen betonnen kegelbreuk: Bijlage C2
Randafstand om spleetbreuk onder belasting te voorkomen: Bijlage C2
Robuustheid: Bijlagen C2-C4
Montagekoppel: Bijlagen B3, B4
Minimale rand- en hartafstand: Bijlagen B3, B4
Kenmerkende weerstand tegen schuifbelasting (statische en quasi-statische belasting):
Weerstand tegen staalbreuk: Bijlage C1
Weerstand tegen uitbreken (pryout): Bijlage C2
Weerstand tegen bezwijken van betonranden: Bijlage C2
Verplaatsingen onder korte- en langetermijnbelading:
Verplaatsingen onder korte- en langetermijnbelading: Bijlagen C5
Kenmerkende weerstand en verplaatsingen voor de seismische prestatiecategorieën C1 en C2:
Trekkrachtweerstand, verplaatsingen categorie C1: NPD
Trekkrachtweerstand, verplaatsingen categorie C2: NPD
Weerstand afschuifbelasting, verplaatsingen categorie C1: NPD
Weerstand afschuifbelasting, verplaatsingen categorie C2: NPD
Factor ringvormige opening: NPD
Hygiëne, gezondheid en milieu (BWR 3)
Content, emission and/or release of dangerous substances: NPD
8. Geëigende technische documentatie en/of specifieke technische documentatie: **-**

De prestaties van het hierboven omschreven product zijn conform de aangegeven prestaties. Deze prestatieverklaring wordt in overeenstemming met Verordening (EU) nr. 305/2011 onder de exclusieve verantwoordelijkheid van de hierboven vermelde fabrikant verstrekt.

Ondertekend voor en namens de fabrikant door:



Dr.-Ing. Oliver Geibig, Directeur Business Units & Engineering
Tumlingen, 2022-09-16



Jürgen Grün, Directeur Chemie & Kwaliteit

Deze DoP is opgesteld in meerdere talen. In het geval van geschillen over de interpretatie zal de Engelse tekst altijd prevaleren.

Het aanhangsel bevat vrijwillige en aanvullende informatie in het Engels die de (taal-neutraal gespecificeerde) wettelijke vereisten overschrijdt.

Translation guidance Essential Characteristics and Performance Parameters for Annexes

Vertaal assistent van de essentiële kenmerken en eigenschappen voor bijlagen

Mechanical resistance and stability (BWR 1)		
Mechanische weerstand en stabiliteit (BWR 1)		
Characteristic resistance to tension load (static and quasi-static loading):		
Kenmerkende weerstand tegen trekbelasting (statische en quasi-statische belasting):		
1	Resistance to steel failure: Weerstand tegen staalbreuk:	$N_{Rk,s}$ [kN]
2	Resistance to combined pull- out and concrete cone failure: Weerstand tegen gecombineerd uittrekken en betonnen kegelbreuk:	T_{Rk} and/or $T_{Rk,100}$ [N/mm ²], ψ_{sus}^0 [-] (BF) $N_{Rk,p}$ and/or $N_{Rk,p,100}$ [kN] (BEF)
3	Resistance to concrete cone failure: Weerstand tegen betonnen kegelbreuk:	$c_{cr,N}$ [mm], $k_{cr,N}$, $k_{ucr,N}$ [-]
4	Edge distance to prevent splitting under load: Randafstand om spleetbreuk onder belasting te voorkomen:	$c_{cr,sp}$ [mm]
5	Robustness: Robuustheid:	γ_{inst} [-]
6	Maximum installation torque:	max T_{inst} [Nm] (BF)
	Installation torque: Montagekoppel:	T_{inst} [Nm] (BEF)
7	Minimum edge distance and spacing: Minimale rand- en hartafstand:	c_{min} , s_{min} , h_{min} [mm]
Characteristic resistance to shear load (static and quasi-static loading):		
Kenmerkende weerstand tegen schuifbelasting (statische en quasi-statische belasting):		
8	Resistance to steel failure: Weerstand tegen staalbreuk:	$V_{Rk,s}^0$ [kN], $M_{Rk,s}^0$ [Nm], k_7 [-]
9	Resistance to pry-out failure: Weerstand tegen uitbreken (pryout):	k_B [-]
10	Resistance to concrete edge failure: Weerstand tegen bezwijken van betonranden:	d_{nom} , l_f [mm]
Displacements under short-term and long-term loading:		
Verplaatsingen onder korte- en langetermijnbelading:		
11	Displacements under short-term and long-term loading: Verplaatsingen onder korte- en langetermijnbelading:	δ_0 , δ_{∞} [mm or mm/(N/mm ²)]
Characteristic resistance and displacements for seismic performance categories C1 and C2:		
Kenmerkende weerstand en verplaatsingen voor de seismische prestatiecategorieën C1 en C2:		
12	Resistance to tension load, displacements:	
	Trekkrachtweerstand, verplaatsingen categorie C1:	C1 $N_{Rk,s,C1}$ [kN] (all) $T_{Rk,C1}$ [N/mm ²] (BF) $N_{Rk,p,C1}$ [kN] (BEF)
	Trekkrachtweerstand, verplaatsingen categorie C2:	C2 $N_{Rk,s,C2}$ [kN] (all) $T_{Rk,C2}$ [N/mm ²] (BF) $N_{Rk,p,C2}$ [kN] (BEF) $\delta_{N,C2}$ [mm] (all)
13	Resistance to shear load, displacements:	
	Weerstands afschuifbelasting, verplaatsingen categorie C1:	C1 $V_{Rk,s,C1}$ [kN] (all)
	Weerstands afschuifbelasting, verplaatsingen categorie C2:	C2 $V_{Rk,s,C2}$ [kN] (all) $\delta_{V,C2}$ [mm] (all)
14	Factor annular gap: Factor ringvormige opening:	α_{gap} [-]
Hygiene, health and the environment (BWR 3)		
Hygiëne, gezondheid en milieu (BWR 3)		
15	Content, emission and/or release of dangerous substances: Content, emission and/or release of dangerous substances:	-

Specific Part

1 Technical description of the product

The "fischer Highbond-Anchor FHB II for diamond drilling / extended working life" consisting of a mortar cartridge with mortar fischer FIS HB or fischer mortar capsule FHB II-P(F) and an anchor rod FHB II - A S or FHB II Inject - A S with hexagon nut and washer.

The glass capsule is set into a drilled hole in the concrete. The special formed anchor rod is driven into the glass capsule by machine with simultaneous hammering and turning. For the injection system the anchor rod is placed into a drilled hole filled with injection mortar. The load transfer is realized by mechanical interlock of several cones in the bonding mortar and then via a combination of bonding and friction forces in the anchorage ground (concrete).

The product description is given in Annex A.

2 Specification of the intended use in accordance with the applicable European Assessment Document

The performances given in Section 3 are only valid if the anchor is used in compliance with the specifications and conditions given in Annex B.

The verifications and assessment methods on which this European Technical Assessment is based lead to the assumption of a working life of the anchor of at least 50 and/or 100 years. The indications given on the working life cannot be interpreted as a guarantee given by the producer, but are to be regarded only as a means for choosing the right products in relation to the expected economically reasonable working life of the works.

3 Performance of the product and references to the methods used for its assessment

3.1 Mechanical resistance and stability (BWR 1)

Essential characteristic	Performance
Characteristic resistance to tension load (static and quasi-static loading)	See Annex C 1 to C 4, B 3 to B 4
Characteristic resistance to shear load (static and quasi-static loading)	See Annex C 1 to C 2
Displacements under short-term and long-term loading	See Annex C 5
Characteristic resistance and displacements for seismic performance categories C1 and C2	No performance assessed

3.2 Hygiene, health and the environment (BWR 3)

Essential characteristic	Performance
Content, emission and/or release of dangerous substances	No performance assessed

4 Assessment and verification of constancy of performance (AVCP) system applied, with reference to its legal base

In accordance with the European Assessment Document EAD 330499-01-0601 the applicable European legal act is: [96/582/EC].

The system to be applied is: 1

Installation conditions part 1

Highbond - Anchor FHB II - A S

Pre-positioned installation

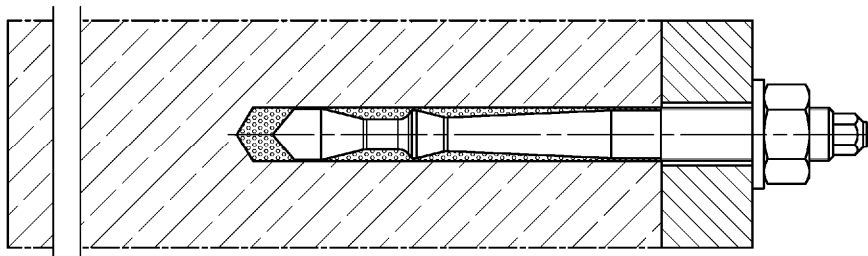

Push through installation

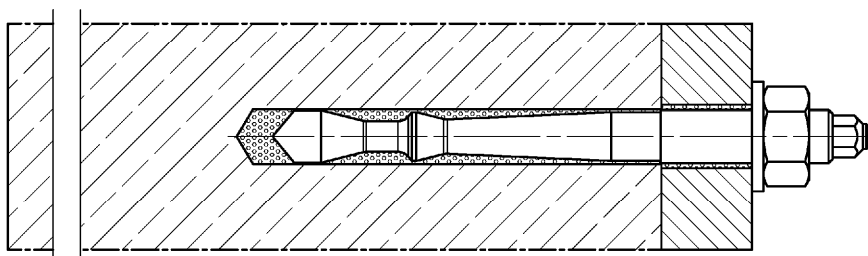

Pre-positioned or push through installation with subsequently injected fischer filling disc (annular gap filled with mortar)

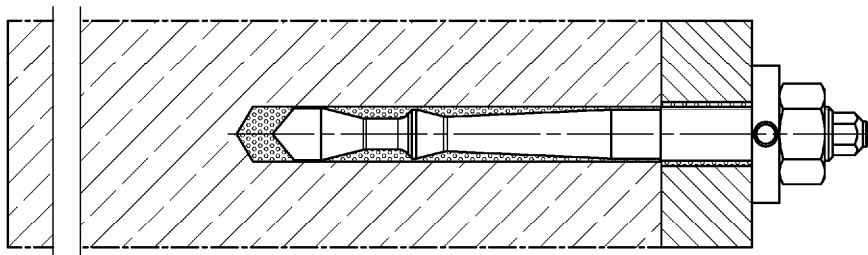

Figures not to scale

fischer Highbond-Anchor FHB II for diamond drilling / extended working life

Product description
Installation conditions part 1; FHB II - A S

Annex A 1

Appendix 3 / 24

Installation conditions part 2

Highbond - Anchor FHB II Inject - A S (only with injection mortar FIS HB)

Pre-positioned installation

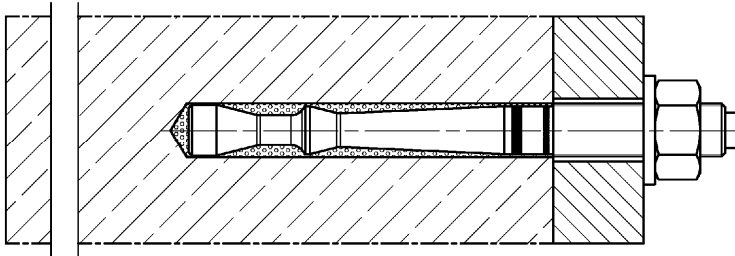

Push through installation

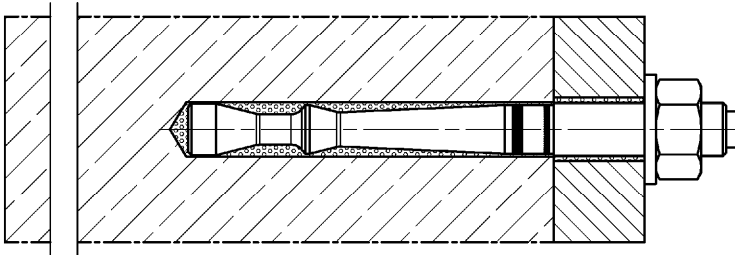

Pre-positioned or push through installation with subsequently injected fischer filling disc (annular gap filled with mortar)

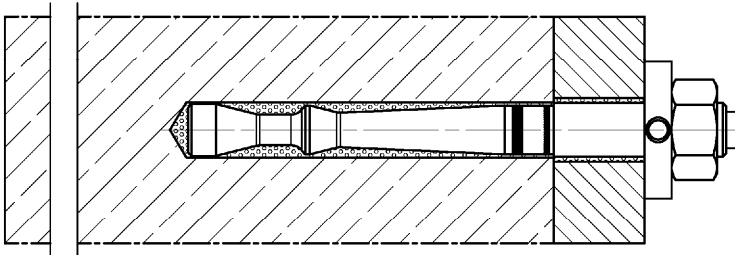

Figures not to scale

fischer Highbond-Anchor FHB II for diamond drilling / extended working life

Product description

Installation conditions part 2; FHB II Inject - A S

Annex A 2

Appendix 4 / 24

Overview system components part 1

Injection cartridge (shuttle cartridge) with sealing cap;

Size: 360 ml, 825 ml

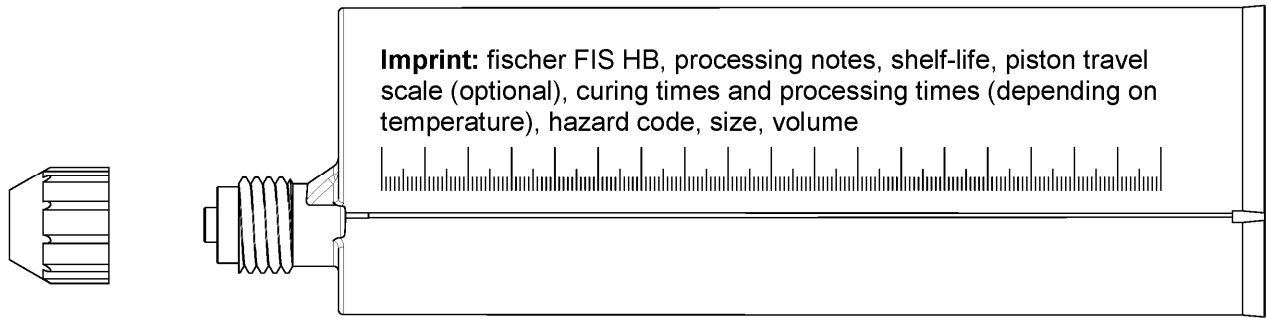

Injection cartridge (coaxial cartridge) with sealing cap;

Size: 150 ml, 300 ml, 380 ml, 400 ml, 410 ml

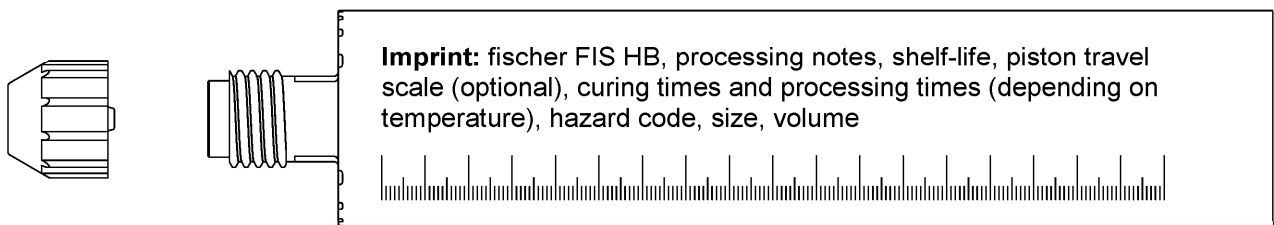

Resin capsule



Static mixer FIS MR Plus for injection cartridges up to 410 ml

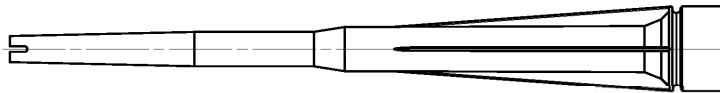

Static mixer FIS JMR for injection cartridge 825 ml

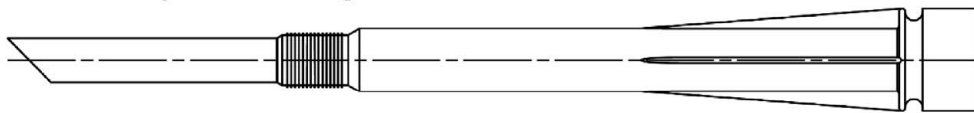

Extension tube Ø 9 for static mixer FIS MR Plus; Extension tube Ø 9 or Ø 15 for static mixer FIS JMR

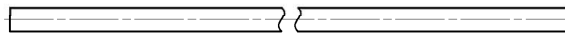

Injection adapter

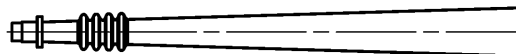

Figures not to scale

fischer Highbond-Anchor FHB II for diamond drilling / extended working life

Product description

Overview system components part 1
cartridges / resin capsule / static mixer / accessories

Annex A 3

Appendix 5 / 24

Overview system components part 2

fischer Highbond - Anchor FHB II and FHB II Inject; pre-assembled condition

Highbond - Anchor FHB II - A S

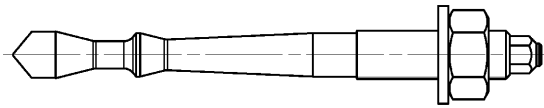

alternative version

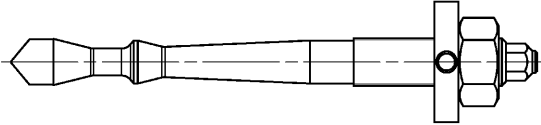

Highbond - Anchor FHB II Inject - A S

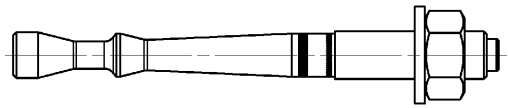

alternative version

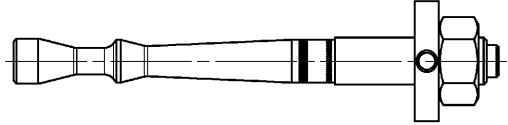

Highbond anchor rod FHB II - A S

Size: M16, M20, M24

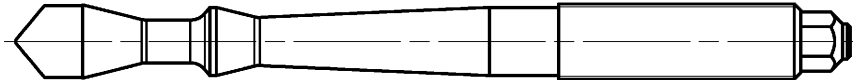

Highbond anchor rod FHB II Inject - A S

Size: M16, M20, M24

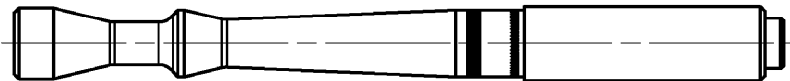

Figures not to scale

fischer Highbond-Anchor FHB II for diamond drilling / extended working life

Product description

Overview system components part 2
anchor rod

Annex A 4

Appendix 6 / 24

Overview system components part 3

fischer filling disc (various versions)

radial

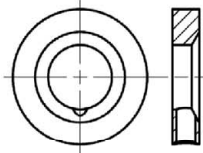

angular

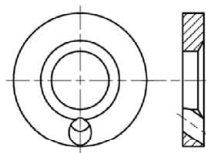

axial

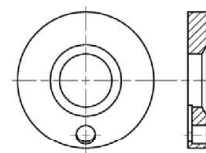

conical washer

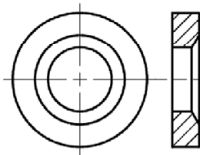

washer

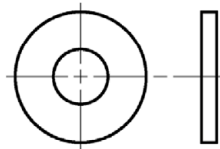

hexagon nut

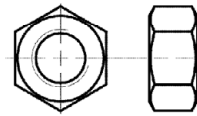

Cleaning brush BS

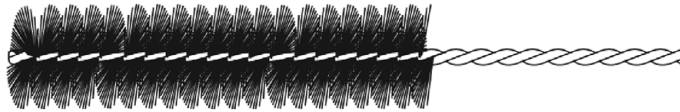

Compressed-air cleaning tool ABP with compressed-air nozzle:



or blow-out pump ABG:



Figures not to scale

fischer Highbond-Anchor FHB II for diamond drilling / extended working life

Product description

Overview system components part 3
metal parts / cleaning brush / blow-out pump





Annex A 5

Appendix 7 / 24

Table A6.1: Materials				
Part	Designation	Material		
1	Injection cartridge	Mortar, hardener, filler		
2	Resin capsule	Mortar, hardener, filler		
	Steel grade	Steel	Stainless steel A4	High corrosion resistant steel C
		zink plated	acc. to EN 10088-1:2014 Corrosion resistance class CRC III acc. to EN 1993-1-4:2006+A1:2015	acc. to EN 10088-1:2014 Corrosion resistance class CRC V acc. to EN 1993-1-4:2006+A1:2015
3	Highbond-Anchor rod FHB II - A S or FHB II Inject - A S	Property class 8.8 EN ISO 898-1:2013 electroplated $\geq 5 \mu\text{m}$ ISO 4042:2018/Zn5/An(A2K) acc. to EN ISO 4042:2018 $A_5 > 12 \%$ fracture elongation	Property class 80 EN ISO 3506-1:2020 1.4401; 1.4404; 1.4578; 1.4571; 1.4439; 1.4362; 1.4062, 1.4662, 1.4462; EN 10088-1:2014 $A_5 > 12 \%$ fracture elongation	Property class 80 EN ISO 3506-1:2020 1.4565; 1.4529; EN 10088-1:2014 $A_5 > 12 \%$ fracture elongation
4	Washer ISO 7089:2000	electroplated $\geq 5 \mu\text{m}$ ISO 4042:2018/Zn5/An(A2K) acc. to EN ISO 4042:2018	1.4401; 1.4404; 1.4578; 1.4571; 1.4439; 1.4362; EN 10088-1:2014	1.4565; 1.4529; EN 10088-1:2014
5	Hexagon nut	Property class 8 acc. to EN ISO 898-2:2012 electroplated $\geq 5 \mu\text{m}$, ISO 4042:2018/Zn5/An(A2K) acc. to EN ISO 4042:2018	Property class 70 or 80 EN ISO 3506-2:2020 1.4401; 1.4404; 1.4578; 1.4571; 1.4439; 1.4362; EN 10088-1:2014	Property class 70 or 80 EN ISO 3506-2:2020 1.4565; 1.4529; EN 10088-1:2014
6	Conical washer or fischer filling disc	electroplated $\geq 5 \mu\text{m}$, ISO 4042:2018/Zn5/An(A2K) acc. to EN ISO 4042:2018	1.4401; 1.4404; 1.4578; 1.4571; 1.4439; 1.4362; EN 10088-1:2014	1.4565; 1.4529; EN 10088-1:2014
fischer Highbond-Anchor FHB II for diamond drilling / extended working life				Annex A 6 Appendix 8 / 24
Product description Materials				

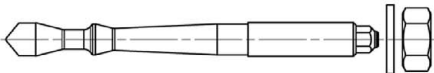
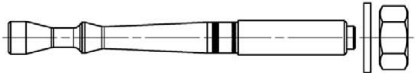
Specifications of intended use part 1

Table B1.1: Overview installation und use

		fischer Highbond-Anchor FHB II with injection mortar FIS HB or resin capsule FHB II-P / FHB II-PF	
		FHB II - A S 	FHB II Inject - A S 
		injection mortar FIS HB or resin capsule FHB II-P / FHB II-PF	injection mortar FIS HB
Hammer drilling with standard drill bit		all sizes	
Hammer drilling with hollow drill bit		all sizes (Heller "Duster Expert"; Bosch "Speed Clean"; Hilti "TE-CD, TE-YD")	
Diamond drilling		all sizes (only with resin capsule allowed)	no performance assessed
Static or quasi static load, in	uncracked concrete	all sizes	all sizes
	cracked concrete	Tables: C1.1, C2.1, C3.1, C3.2, C4.1, C5.1, C5.2	Tables: C1.1, C2.1, C4.1, C5.2
Installation and use condition	11 dry or wet concrete	all sizes	
	12 water-filled hole	all sizes (only with resin capsule allowed)	no performance assessed
seismic performance category C1 and C2		no performance assessed	
Installation direction		D3 (downwards, horizontal and upwards (overhead) installation)	
Installation	Pre-positioned	all sizes	
	Push through	all sizes	
Installation temperature ¹⁾		FIS HB: $T_{i,min} = -5\text{ °C}$ to $T_{i,max} = +40\text{ °C}$	
		FHB II-P / PF: $T_{i,min} = -5\text{ °C}$ to $T_{i,max} = +40\text{ °C}$	
Service temperature	Temperature range T2	-40 °C to +80 °C (max. short term temperature +80 °C; max. long term temperature +50 °C)	

¹⁾ For the standard variation of temperature after installation

Figures not to scale

fischer Highbond-Anchor FHB II for diamond drilling / extended working life

Intended use
Specifications part 1

Annex B 1

Appendix 9 / 24

Specifications of intended use part 2

Base materials:

- Compacted reinforced or unreinforced normal weight concrete without fibres of strength classes C20/25 to C50/60 according to EN 206:2013+A1:2016

Use conditions (Environmental conditions):

- Structures subject to dry internal conditions (zinc plated steel, stainless steel or high corrosion resistant steel)
- For all other conditions according to EN1993-1-4: 2006+A1:2015 corresponding to corrosion resistance classes to Annex A 6 table 6.1.

Design:

- Fastenings are designed under the responsibility of an engineer experienced in fastenings and concrete work
- Verifiable calculation notes and drawings are to be prepared taking account of the loads to be anchored. The position of the fastener is indicated on the design drawings (e.g. position of the fastener relative to reinforcement or to supports, etc.)
- Fastenings are designed in accordance with:
EN 1992-4:2018 and EOTA Technical Report TR 055, Edition February 2018

Installation:

- Fastener installation is to be carried out by appropriately qualified personnel and under the supervision of the person responsible for technical matters of the site
- Overhead installation is allowed (necessary equipment see installation instruction)

fischer Highbond-Anchor FHB II for diamond drilling / extended working life

Intended Use
Specifications part 2

Annex B 2

Appendix 10 / 24

Table B3.1: Installation parameters for Highbond – Anchor rod FHB II - A S

Anchor rod FHB II - A S		Thread	M16x95	M20x170	M24x170
Corresponding resin capsules FHB II-P or FHB II-PF		[-]	16x95	20x170	24x170
Cone diameter	d_k	[mm]	14,5	23,0	
Width across flats	SW		24	30	36
Nominal drill hole diameter	d_0		16	25	
Drill hole depth	h_0		110	190	
Effective embedment depth	h_{ef}		95	170	
Minimum spacing and minimum edge distance	$s_{min} = c_{min}$		50	80	
Diameter of clearance hole of the fixture	pre-positioned installation		$d_f \leq$	18	22
	push through installation	$d_f \leq$	18	26	
Min. thickness of concrete member	h_{min}		150	240	
Installation torque	T_{inst}	[Nm]	50	100	
Thickness of fixture	$t_{fix} \leq$		1500		
fischer filling disc ¹⁾	$\geq d_a$	[mm]	38	46	54
	t_s		7	8	10

¹⁾ Using fischer filling disc reduces t_{fix} (usable length of the anchor)

Highbond – Anchor rod FHB II - A S

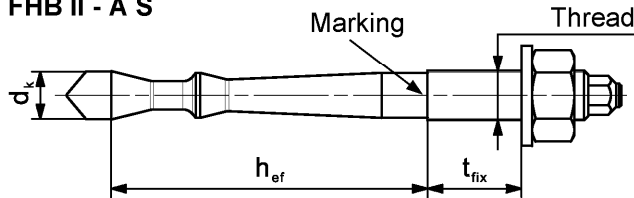

Marking: work symbol, thread diameter, embedment depth e.g.: M16x95
 For stainless steel additional **A4**. For high corrosion resistant steel additional **C**.
 For high corrosion resistant steel additional marking “(“ also on the face side

Installation conditions:

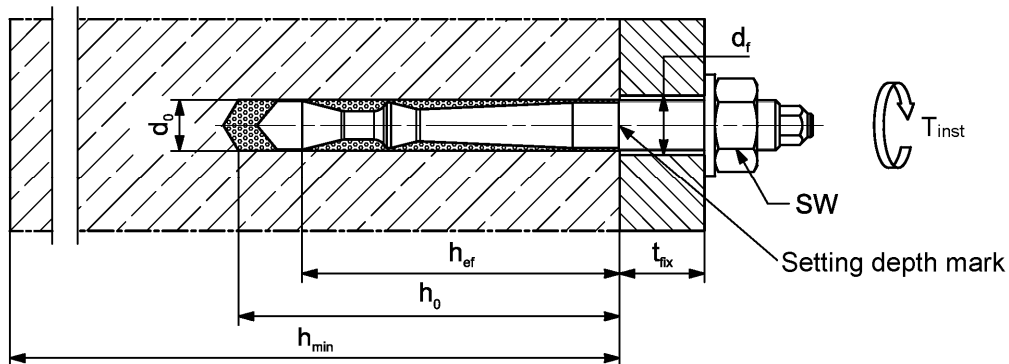

Figures not to scale

fischer Highbond-Anchor FHB II for diamond drilling / extended working life

Intended use
 Installation parameters for Highbond - Anchor FHB II - A S

Annex B 3

Appendix 11 / 24

Table B4.1: Installation parameters for Highbond - Anchor rod FHB II Inject - A S with injectionmortar FIS HB

Anchor rod FHB II Inject - A S		Thread	M16x95	M20x170	M24x170
Cone diameter	d_k	[mm]	14,5	23,0	
Width across flats	SW		24	30	36
Nominal drill hole diameter	d_0		16	25	
Drill hole depth	h_0		101	176	
Effective embedment depth	h_{ef}		95	170	
Minimum spacing and minimum edge distance	$s_{min} = c_{min}$		50	80	
Diameter of clearance hole of the fixture	pre-positioned installation $d_f \leq$		18	22	26
	push through installation $d_f \leq$		20	26	
Min. thickness of concrete member	h_{min}		150	240	
Installation torque	T_{inst}		[Nm]	50	100
Thickness of fixture	$t_{fix} \leq$	[mm]	1500		
fischer filling disc ¹⁾	$\geq d_a$		38	46	54
	t_s		7	8	10

¹⁾ Using fischer filling disc reduces t_{fix} (usable length of the fastener)

Highbond – Anchor rod FHB II Inject - A S

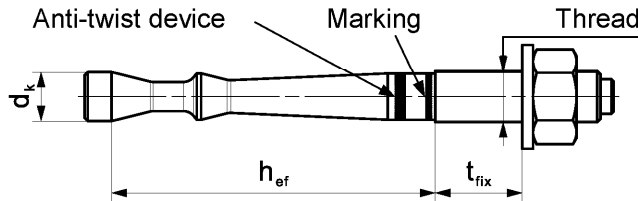

Marking: work symbol, thread diameter, embedment depth e.g.: M16x95
 For stainless steel additional "A4". For high corrosion resistant steel additional "C".
 For high corrosion resistant steel additional marking "(" also on the face side

Installation conditions:

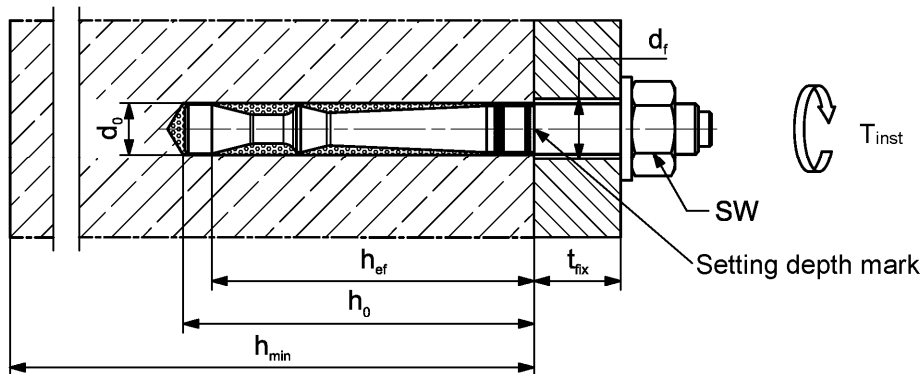

Figures not to scale

fischer Highbond-Anchor FHB II for diamond drilling / extended working life

Intended use
 Installation parameters for Highbond - Anchor FHB II Inject - A S

Annex B 4

Appendix 12 / 24

Table B5.1: Dimensions of resin capsule FHB II-P and FHB II-PF

Resin capsule			16x95	20x170	24x170
Capsule length	L_p	[mm]	120	185	185
Capsule diameter	$\varnothing d_p$		14,5	21,5	

FHB II-P (standard)

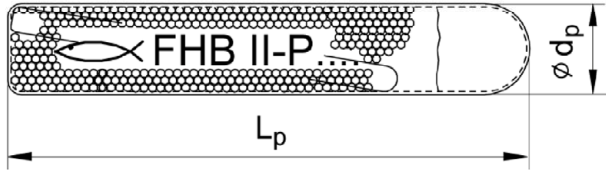

FHB II-PF (fast curing)

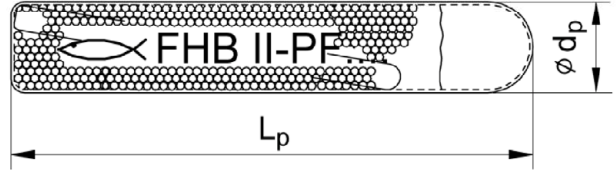

Imprint: work symbol, marking, anchor size and effective embedment depth.

e.g.:  FHB II-P 16x95 or

 FHB II-PF 16x95

Table B5.2: Parameters of the cleaning brush BS (steel brush with steel bristles; only when using injection mortar or resin capsule with diamond drill bit)

The size of the cleaning brush refers to the nominal drill hole diameter

Nominal drill hole diameter	d_0	[mm]	16	25
Steel brush diameter BS	d_b		20	27

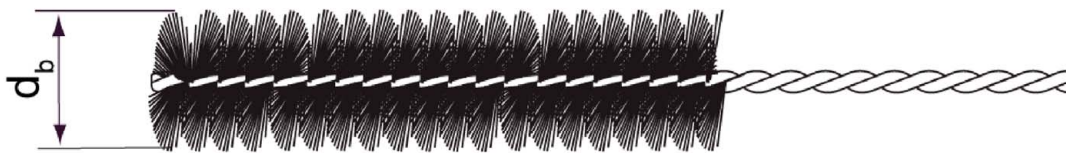

Figures not to scale

fischer Highbond-Anchor FHB II for diamond drilling / extended working life

Intended use
 Dimensions resin capsule
 Parameters cleaning brush (steel brush)

Annex B 5

Appendix 13 / 24

Table B6.1: Processing time and curing time of the injection mortar FIS HB

Temperature at anchoring base ¹⁾ [°C]	Maximum processing time t_{work}	Minimum curing time ²⁾ t_{cure}
-5 to 0 ³⁾	-	6 h
> 0 to 5 ³⁾	-	3 h
> 5 to 10	15 min	90 min
> 10 to 20	6 min	35 min
> 20 to 30	4 min	20 min
> 30 to 40	2 min	12 min

¹⁾ During the curing time of the mortar the temperature of the anchoring base may not fall below the listed minimum temperature

²⁾ In wet concrete the curing time must be doubled

³⁾ Minimal cartridge temperature +5 °C

Table B6.2: Curing time of the resin capsule FHB II-P and FHB II-PF

Resin capsule FHB II-P (standard)		Resin capsule FHB II-PF (fast curing)	
Temperature at anchoring base ¹⁾ [°C]	Minimum curing time ²⁾ t_{cure}	Temperature at anchoring base ¹⁾ [°C]	Minimum curing time ²⁾ t_{cure}
-5 to 0	4 h	-5 to 0	8 min
> 0 to 10	45 min	> 0 to 10	6 min
> 10 to 20	20 min	> 10 to 20	4 min
> 20	10 min	> 20	2 min

¹⁾ During the curing time of the mortar the temperature of the anchoring base may not fall below the listed minimum temperature.

²⁾ In wet concrete or water-filled holes the curing times must be doubled

fischer Highbond-Anchor FHB II for diamond drilling / extended working life

Intended use
Processing time and curing time

Annex B 6

Appendix 14 / 24

Installation instructions part 1; Installation with resin capsule FHB II-P or FHB II-PF

Drilling the drill hole (hammer drilling with standard drill bit)

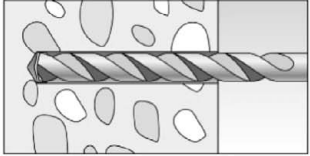
1		<p>Drill the hole. Nominal drill hole diameter d_0 and drill hole depth h_0 see table B3.1 Cleaning of the drill hole is not necessary</p>
---	---	---

Go to step 6 (Annex B 8)

Drilling and cleaning the drill hole (hammer drilling with hollow drill bit)

1		<p>Check a suitable hollow drill (see table B1.1) for correct operation of the dust extraction</p>
---	---	---

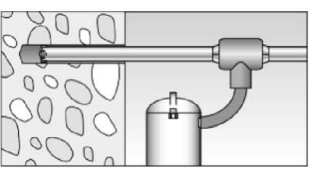
2		<p>Use a suitable dust extraction system, e.g. fischer FVC 35 M or a comparable dust extraction system with equivalent performance data. Drill the hole with hollow drill bit. The dust extraction system has to extract the drill dust nonstop during the drilling process and must be adjusted to maximum power. Nominal drill hole diameter d_0 and drill hole depth h_0 see table B3.1</p>
---	---	---

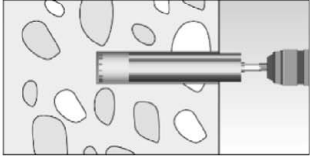
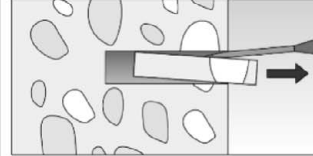

Go to step 6 (Annex B 8)

Drilling and cleaning the drill hole (wet drilling with diamond drill bit)

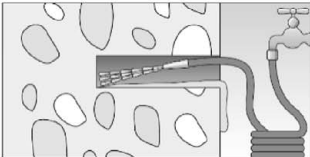
1		<p>Drill the hole. Drill hole diameter d_0 and nominal drill hole depth h_0 see table B3.1</p>		<p>Break the drill core and remove it</p>
---	---	---	--	---

2		<p>Flush the drill hole, until clear water emerges from the drill hole.</p>
---	--	---

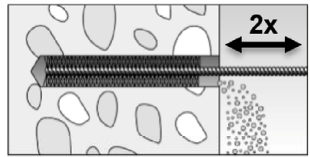
3		<p>Blow out the drill hole twice, using oil-free compressed air ($p \geq 6$ bar)</p>
---	---	---

4		<p>Brush the drill hole twice. Corresponding cleaning brush BS see table B5.2</p>	
---	---	--	---

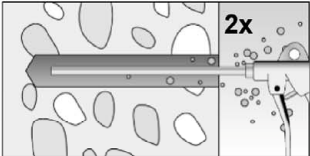
5		<p>Blow out the drill hole twice, using oil-free compressed air ($p \geq 6$ bar)</p>
---	---	---

Go to step 6 (Annex B 8)

fischer Highbond-Anchor FHB II for diamond drilling / extended working life

Intended use



Installation instructions part 1
Installation with resin capsule FHB II-P or FHB II-PF

Annex B 7

Appendix 15 / 24

Installation instructions part 2; Installation with resin capsule FHB II-P or FHB II-PF

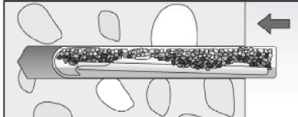
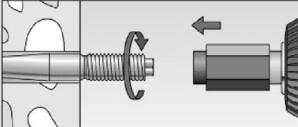
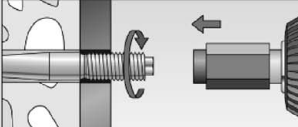
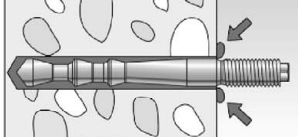
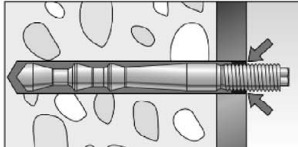
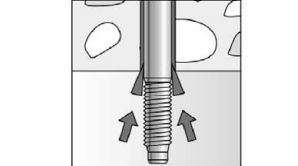
Installation Highbond-Anchor rod FHB II - A S

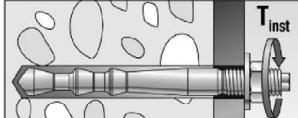
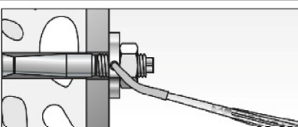
6		Insert the resin capsule FHB II-P or FHB II-PF into the drill hole by hand.
7		Pre-positioned installation: Only use Highbond-Anchor rods FHB II - A S with roof-shaped point . Drive in the Anchor rod using a hammer drill or impact drill. When reaching the setting depth mark stop the drill immediately.
7		Push through installation: Only use Highbond-Anchor rods FHB II - A S with roof-shaped point . Drive in the anchor rod using a hammer drill or impact drill. When reaching the setting depth mark stop the drill immediately.
8		Pre-positioned installation: After inserting the anchor rod, excess mortar must be emerged around the anchor.
8		Push through installation: After inserting the anchor rod, excess mortar must be emerged from the drill hole and must be visible in the fixture.
8a		For overhead installations support the anchor rod with wedges. (e.g. fischer centering wedges) 
9		Wait for the specified curing time t_{cure} see table B6.2
10		Installation torque for the hexagon nut T_{inst} see table B3.1, B4.1
Option		The gap between metal parts and fixture (annular gap) may be filled with mortar via the fischer filling disc. Compressive strength $\geq 50 \text{ N/mm}^2$ (e.g. FIS HB, FIS SB, FIS V, FIS V Plus, FIS EM Plus). ATTENTION: Using fischer filling disc reduces t_{fix} (usable length of the anchor)

fischer Highbond-Anchor FHB II for diamond drilling / extended working life

Intended use

Installation instructions part 2
 Installation with resin capsule FHB II-P or FHB II-PF

Annex B 8

Installation instructions part 3; Installation with injection mortar FIS HB

Drilling and cleaning the drill hole (hammer drilling with standard drill bit)

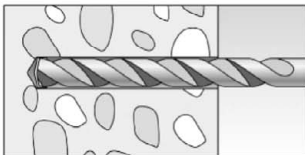
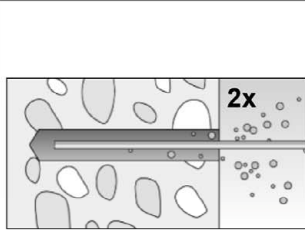
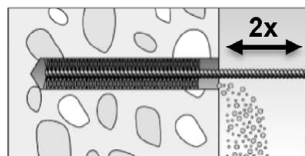
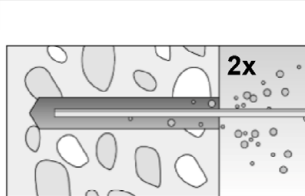
1		<p>Drill the hole Nominal drill hole diameter d_0 and drill hole depth h_0 see tables B3.1, B4.1</p>
2		<p>Clean the drill hole. Blow out the drill hole twice. If necessary, remove standing water out of the bore hole</p> <p>For drill hole diameter $d_0 = 16 \text{ mm}$ blow out the hole by hand or oil-free compressed air ($\geq 6 \text{ bar}$). For drill hole diameter $d_0 = 25 \text{ mm}$ blow out the hole with oil-free compressed air ($\geq 6 \text{ bar}$). Use a compressed-air nozzle.</p>
3		<p>Brush the bore hole twice. Corresponding cleaning brush BS see table B5.2</p>
4		<p>Clean the drill hole. Blow out the drill hole twice.</p> <p>For drill hole diameter $d_0 = 16 \text{ mm}$ blow out the hole by hand or oil-free compressed air ($\geq 6 \text{ bar}$). For drill hole diameter $d_0 = 25 \text{ mm}$ blow out the hole with oil-free compressed air ($\geq 6 \text{ bar}$). Use a compressed-air nozzle.</p>

Go to step 5 (Annex B 10)

Drilling and cleaning the drill hole (hammer drilling with hollow drill bit)

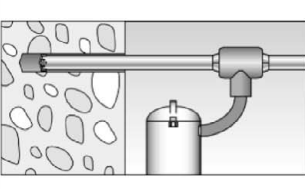
1		<p>Check a suitable hollow drill (see table B1.1) for correct operation of the dust extraction</p>
2		<p>Use a suitable dust extraction system, e.g. fischer FVC 35 M or a comparable dust extraction system with equivalent performance data.</p> <p>Drill the hole with hollow drill bit. The dust extraction system has to extract the drill dust nonstop during the drilling process and must be adjusted to maximum power.</p> <p>Nominal drill hole diameter d_0 and drill hole depth h_0 see tables B3.1, B4.1</p>

Go to step 5 (Annex B 10)

fischer Highbond-Anchor FHB II for diamond drilling / extended working life

Intended use



Installation instructions part 3
Installation with injection mortar FIS HB

Annex B 9

Appendix 17 / 24

Installation instruction part 4; Installation with injection mortar FIS HB

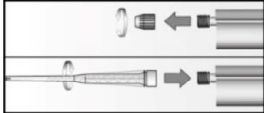
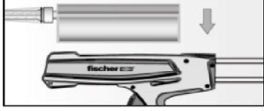
Preparing the cartridge

5		Remove the sealing cap Screw on the static mixer (the spiral in the static mixer must be clearly visible)
6		Place the cartridge into the dispenser
7		Extrude approximately 10 cm of material out until the resin is evenly grey in colour. Do not use mortar that is not uniformly grey

Injection of the mortar

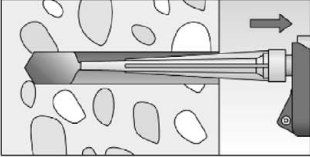
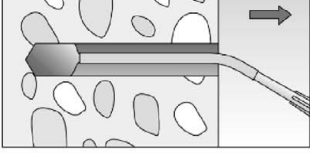
8		Fill approximately 2/3 of the drill hole with mortar. Always begin from the bottom of the hole and avoid bubbles
		For drill hole depth ≥ 170 mm use an extension tube

Go to step 9 (Annex B 11)

fischer Highbond-Anchor FHB II for diamond drilling / extended working life

Intended use

Installation instructions part 4
Installation with injection mortar

Annex B 10

Appendix 18 / 24

Installation instruction part 5; Installation with injection mortar FIS HB

Installation Highbond-Anchor rod FHB II - A S or FHB II Inject - A S

9		<p>Pre-positioned or push through installation: Push the anchor rod down to the bottom of the hole, turning it slightly while doing so. Only use clean and oil-free metal parts.</p>
10		<p>Pre-positioned installation: After inserting the anchor rod, excess mortar must be emerged around the anchor.</p>
		<p>Push through installation: After inserting the anchor rod, excess mortar must be emerged from the drill hole and must be visible in the fixture.</p>
10a		<p>For overhead installations support the anchor rod with wedges. (e.g. fischer centering wedges)</p> 
11		<p>Wait for the specified curing time t_{cure} see table B6.1</p>
12		<p>Installation torque for the hexagon nut T_{inst} see table B3.1, B4.1</p>
Option		<p>The gap between metal parts and fixture (annular gap) may be filled with mortar via the fischer filling disc. Compressive strength $\geq 50 \text{ N/mm}^2$ (e.g. FIS HB, FIS SB, FIS V, FIS V Plus, FIS EM Plus). ATTENTION: Using fischer filling disc reduces t_{fix} (usable length of the anchor)</p>



Table C1.1: Characteristic resistance to steel failure under tension / shear loading of Highbond-Anchor rods FHB II - A S and FHB II Inject - A S

Anchor rod FHB II - A S / FHB II Inject - A S		M16x95	M20x170	M24x170	
Characteristic resistance to steel failure under tension loading					
Characteristic resistance $N_{Rk,s}$	Steel, zinc plated	[kN]	61,6	128,5	
	Stainless steel A4		61,6	128,5	
	High corrosion resistant steel C				
Partial factors ¹⁾					
Partial factor $\gamma_{Ms,N}$	Steel, zinc plated	[-]	1,5 ¹⁾		
	Stainless steel A4		1,5 ¹⁾		
	High corrosion resistant steel C		1,5 ¹⁾		
Characteristic resistance to steel failure under shear loading					
without lever arm					
Characteristic resistance $V^0_{Rk,s}$	Steel, zinc plated	[kN]	50,8	80,3	114,2
	Stainless steel A4		62,7	97,9	124,5
	High corrosion resistant steel C		62,7	97,9	141
Ductility factor	k_7	[-]	1,0		
with lever arm					
Characteristic resistance $M^0_{Rk,s}$	Steel, zinc plated	[Nm]	266	519	896
	Stainless steel A4		266	519	896
	High corrosion resistant steel C				
Partial factors ¹⁾					
Partial factor	$\gamma_{Ms,V}$	[-]	1,25		
¹⁾ In absence of other national regulations					
fischer Highbond-Anchor FHB II for diamond drilling / extended working life				Annex C 1 Appendix 20 / 24	
Performance Characteristic resistance to steel failure under tension / shear loading of Highbond-Anchor rods FHB II - A S and FHB II Inject - A S					

Table C2.1: Characteristic resistance to concrete failure under tension / shear loading

Anchor rod FHB II - A S / FHB II Inject - A S		All sizes			
Characteristic resistance to concrete failure under tension loading					
Installation factor	γ_{inst}	[-]	See annex C 3 to C 4		
Factors for the compressive strength of concrete > C20/25					
Increasing factor for uncracked or cracked concrete $N_{Rk,p} = \psi_c N_{Rk,p} (C20/25)$	C25/30	[-]	1,12		
	C30/37		1,22		
	C35/45		1,32		
	C40/50		1,41		
	C45/55		1,50		
	C50/60		1,58		
Splitting failure					
Edge distance	$C_{cr,sp}$	[mm]	2 h_{ef}		
Spacing	$S_{cr,sp}$		4 h_{ef}		
Concrete cone failure					
Uncracked concrete	$k_{ucr,N}$	[-]	11,0 ¹⁾		
Cracked concrete	$k_{cr,N}$		7,7 ¹⁾		
Edge distance	$C_{cr,N}$	[mm]	1,5 h_{ef}		
Spacing	$S_{cr,N}$		3 h_{ef}		
Characteristic resistance to concrete failure under shear loading					
Installation factor	γ_{inst}	[-]	1,0		
Concrete pry-out failure					
Factor for pry-out failure	k_8	[-]	2,0		
Concrete edge failure					
Anchor rod FHB II - A S and FHB II Inject - A S			M16x95	M20x170	M24x170
Effective length of fastener in shear loading	l_f	[mm]	95	170	
Calculation diameter	d_{nom}		16	25	
¹⁾ Related to concrete cylinder compressive strength					
fischer Highbond-Anchor FHB II for diamond drilling / extended working life					Annex C 2 Appendix 21 / 24
Performance Characteristic resistance to concrete failure under tension / shear loading					

Table C3.1: Characteristic resistance to pull-out failure for Highbond-Anchor rods FHB II - A S with resin capsule FHB II-P or FHB II-PF in diamond drilled holes; 50 years

Highbond-Anchor rod FHB II - A S ¹⁾		M16x95	M20x170	M24x170
Characteristic resistance to pull-out failure				
Calculation diameter	d	[mm]	16	25
Uncracked concrete				
Characteristic resistance in uncracked concrete C20/25				
<u>Diamond-drilling (dry or wet concrete / water-filled hole)</u>				
Temperature range T2	50 °C / 80 °C	N _{Rk,p,ucr}	[kN]	51,5
				118,5
Cracked concrete				
Characteristic resistance in cracked concrete C20/25				
<u>Diamond-drilling (dry or wet concrete / water-filled hole)</u>				
Temperature range T2	50 °C / 80 °C	N _{Rk,p,cr}	[kN]	42,8
				101,4
Installation factors				
Dry or wet concrete				1,2
Water-filled hole	γ_{inst}	[-]		1,2

¹⁾ Highbond-Anchor rod FHB II - A S with resin capsule FHB II-P / FHB II-PF

Table C3.2: Characteristic resistance to pull-out failure for Highbond-Anchor rods FHB II - A S with resin capsule FHB II-P or FHB II-PF in diamond drilled holes; 100 years

Highbond-Anchor rod FHB II - A S ¹⁾		M16x95	M20x170	M24x170
Characteristic resistance to pull-out failure				
Calculation diameter	d	[mm]	16	25
Uncracked concrete				
Characteristic resistance in uncracked concrete C20/25				
<u>Diamond-drilling (dry or wet concrete / water-filled hole)</u>				
Temperature range T2	50 °C / 80 °C	N _{Rk,p,ucr,100}	[kN]	51,5
				118,5
Cracked concrete				
Characteristic resistance in cracked concrete C20/25				
<u>Diamond-drilling (dry or wet concrete / water-filled hole)</u>				
Temperature range T2	50 °C / 80 °C	N _{Rk,p,cr,100}	[kN]	36,0
				86,0
Installation factors				
Dry or wet concrete				1,2
Water-filled hole	γ_{inst}	[-]		1,2

¹⁾ Highbond-Anchor rod FHB II - A S with resin capsule FHB II-P / FHB II-PF

fischer Highbond-Anchor FHB II for diamond drilling / extended working life

Performance

Characteristic resistance to pull-out failure for Highbond-Anchor rods FHB II - A S in diamond drilled holes; 50 or 100 years

Annex C 3

Appendix 22 / 24

Table C4.1: Characteristic resistance to pull-out failure for Highbond-Anchor rods FHB II - A S with resin capsule FHB II-P / FHB II-PF or injection mortar FIS HB and FHB II Inject - A S with injection mortar FIS HB in hammer drilled holes; 100 years

Anchor rod FHB II - A S ¹⁾ FHB II Inject - A S ²⁾		M16x95	M20x170	M24x170
Characteristic resistance to pull-out failure				
Calculation diameter	d [mm]	16	25	
Uncracked concrete				
Characteristic resistance in uncracked concrete C20/25				
Hammer-drilling with standard or hollow drill bit (dry or wet concrete / water-filled hole)				
Temperature range T2	50 °C / 80 °C	N _{RK,p,ucr,100} [kN]	52,4	118,5
Cracked concrete				
Characteristic resistance in cracked concrete C20/25				
Hammer-drilling with standard or hollow drill bit (dry or wet concrete / water-filled hole)				
Temperature range T2	50 °C / 80 °C	N _{RK,p,cr,100} [kN]	36,0	86,0
Installation factors				
Dry or wet concrete			1,0	
Water-filled hole (only with resin capsule)	γ _{inst}	[-]	1,0	

¹⁾ Highbond-Anchor rod FHB II - A S with resin capsule FHB II-P / FHB II-PF or injection mortar FIS HB
²⁾ Highbond-Anchor rod FHB II Inject - A S with injection mortar FIS HB

Table C5.1: Displacements for Highbond-Anchor rod FHB II - A S; 50 years

Anchor rod FHB II – A S	M16x95	M20x170	M24x170	
Displacement-Factors for tension loading ¹⁾				
Uncracked concrete; Temperature range T2				
δ_{N0} -Factor	[mm/kN]	0,030	0,020	0,016
$\delta_{N\infty}$ -Factor		0,120	0,045	0,045
Cracked concrete; Temperature range T2				
δ_{N0} -Factor	[mm/kN]	0,030	0,020	0,016
$\delta_{N\infty}$ -Factor		0,120	0,045	0,045
Displacement-Factors for shear loading ²⁾				
Uncracked or cracked concrete; Temperature range T2				
δ_{V0} -Factor	[mm/kN]	0,02	0,02	0,02
$\delta_{V\infty}$ -Factor		0,03	0,03	0,03
1) Calculation of effective displacement: $\delta_{N0} = \delta_{N0}\text{-Factor} \cdot N$ $\delta_{N\infty} = \delta_{N\infty}\text{-Factor} \cdot N$ N = acting tension loading		2) Calculation of effective displacement: $\delta_{V0} = \delta_{V0}\text{-Factor} \cdot V$ $\delta_{V\infty} = \delta_{V\infty}\text{-Factor} \cdot V$ V = acting shear loading		

Table C5.2: Displacements for Highbond-Anchor rod FHB II - A S and FHB II Inject - A S; 100 years

Anchor rod FHB II – A S / FHB II Inject - A S	M16x95	M20x170	M24x170	
Displacement-Factors for tension loading ¹⁾				
Uncracked concrete; Temperature range T2				
δ_{N0} -Factor	[mm/kN]	0,030	0,020	0,016
$\delta_{N\infty}$ -Factor		0,120	0,045	0,045
Cracked concrete; Temperature range T2				
δ_{N0} -Factor	[mm/kN]	0,030	0,020	0,016
$\delta_{N\infty}$ -Factor		0,120	0,045	0,045
Displacement-Factors for shear loading ²⁾				
Uncracked or cracked concrete; Temperature range T2				
δ_{V0} -Factor	[mm/kN]	0,02	0,02	0,02
$\delta_{V\infty}$ -Factor		0,03	0,03	0,03
1) Calculation of effective displacement: $\delta_{N0} = \delta_{N0}\text{-Factor} \cdot N$ $\delta_{N\infty} = \delta_{N\infty}\text{-Factor} \cdot N$ N = acting tension loading		2) Calculation of effective displacement: $\delta_{V0} = \delta_{V0}\text{-Factor} \cdot V$ $\delta_{V\infty} = \delta_{V\infty}\text{-Factor} \cdot V$ V = acting shear loading		

fischer Highbond-Anchor FHB II for diamond drilling / extended working life

Performances

Displacements for Highbond-Anchor rod FHB II - A S and FHB II Inject - A S; 50 or 100 years

Annex C 5

Appendix 24 / 24