

Fasenwisselaar als toestelcontactstop

Bestelnr. 330



- schroefklemmen

Technische informatie

Ampère	32 A
Polen	5 p
Voltage	400 V
Uurstand	6 h
Hertz	50-60 Hz
Aansluittechniek	schroefklemmen
Contacten	standaard
Beschermingsgraad	IP 44
Gewicht	258 g
Certificeringen	VDE, EAC, CQC

Tekeningen

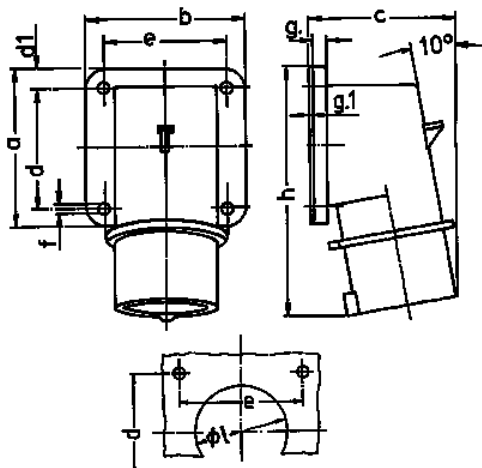

Tekening	Amp. Polen	16		32		
		4	5	3	4	5
2 MB 73						
Maten in mm						
a		85	85	75	75	75
b		85	85	90	90	90
c		75	79	87	87	90
d		64	64	45	45	45
d1		10	10	13	13	13
e		64	64	78	78	78
f		5,5	5,5	5,5	5,5	5,5
g.		6	6	6	6	6
g.1		2	2	2	2	2
h		129	129	137	137	138
i		50	50	55	55	55
Kabelaansluiting						
van/tot mm²		1	1	2,5	2,5	2,5
		-2,5	-2,5	-6	-6	-6