

Data Sheet | Item Number: 2060-471/998-404

SMD PCB terminal block; push-button; 0.75 mm²; Pin spacing 4 mm; 1-pole; Push-in CAGE CLAMP®; in tape-and-reel packaging; black

<https://www.wago.com/2060-471/998-404>

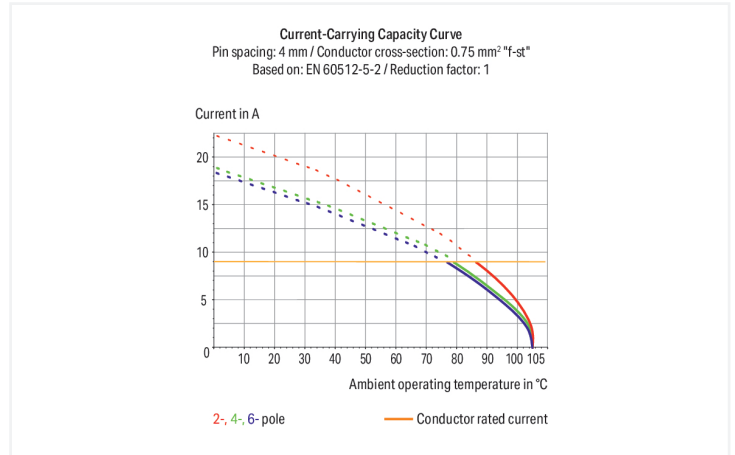

Color: ■ black

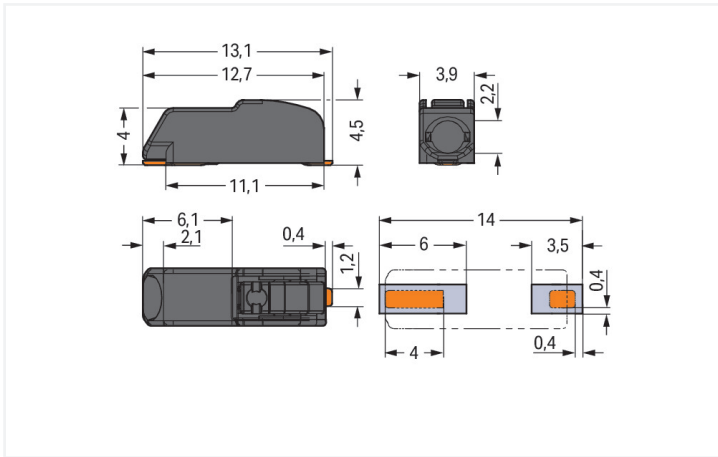

Dimensions in mm

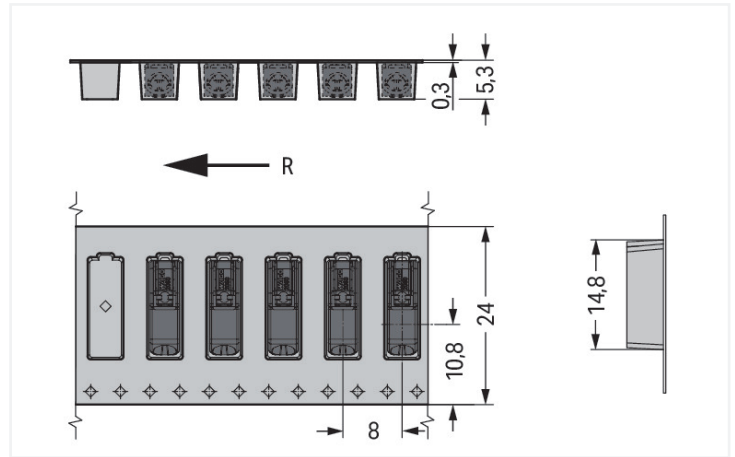

Dimensions in mm
R = feed direction

PCB terminal block, 2060 Series, with 4 mm pin spacing

Our PCB terminal block (item number 2060-471/998-404) is designed for seamless electrical installations. It is perfect for custom installations with different mounting types. Strip lengths must be between 7 and 9 mm when connecting conductors to this PCB terminal block. This product features one conductor terminal and utilizes Push-in CAGE CLAMP®. Our Push-in CAGE CLAMP® is a universal, maintenance-free connection solution for all conductor types, featuring a winning design: both solid and fine-stranded conductors with ferrules can be directly inserted without the need for tools or any preparation, such as crimping the ferrule. The item's dimensions are (3.9 x 4.5 x 13.1) mm (width x height x depth). This PCB terminal block is suitable for conductor cross sections ranging from 0.2 mm² to 0.75 mm².

Tin is used for coating the contact surfaces. A push-button is used to operate this PCB terminal block. The PCB terminal block is designed for SMD soldering. The conductor is designed to be inserted at a 0° angle..

Notes

Note

Application notes:

Suitable for lead-free, reflow-soldering profiles per DIN EN 61760-1 and IEC 60068-2-58 up to max. 260°C peak temperature. Due to application-specific variables (component configuration and orientation, type of soldering machine, solder paste), trial runs are recommended to ensure product and process compatibility under actual manufacturing conditions.

Depending on reflow soldering temperatures and times, color deviations may occur. These deviations will have no impact on functionality.

Recommendation

Recommendation for stencil:

150 µm material thickness; Pattern layout identical to solder pad layout

Electrical data

Ratings per	IEC/EN 60664-1			Ratings	
	III	III	II		
Overvoltage category	III	III	II	Approvals per	UL 1977
Pollution degree	3	2	2	Rated voltage	600 V
Nominal voltage	63 V	160 V	320 V	Rated current	9 A
Rated impulse withstand voltage	2.5 kV	2.5 kV	2.5 kV		
Rated current	9 A	9 A	9 A		

Connection Data

Clamping units	1	Connection 1	
Total number of potentials	1	Connection technology	Push-in CAGE CLAMP®
Number of connection types	1	Actuation type	Push-button
Number of levels	1	Solid conductor	0.2 ... 0.75 mm ² / 24 ... 18 AWG
		Fine-stranded conductor	0.2 ... 0.75 mm ² / 24 ... 18 AWG
		Fine-stranded conductor; with insulated ferrule	0.25 ... 0.34 mm ²
		Fine-stranded conductor; with uninsulated ferrule	0.25 ... 0.34 mm ²
		Strip length	7 ... 9 mm / 0.28 ... 0.35 inches
		Conductor connection direction to PCB	0°
		Pole number	1

Physical data

Pin spacing	4 mm / 0.157 inches
Width	3.9 mm / 0.154 inches
Height	4.5 mm / 0.177 inches
Depth	13.1 mm / 0.516 inches
Reel diameter of tape-and-reel packaging	330 mm
Tape width	24 mm

PCB contact

PCB contact	SMD
Solder pin arrangement	over the entire terminal strip (in-line)
Number of solder pins per potential	2

Material data

Note (material data)	Information on material specifications can be found here
Color	black
Material group	I
Insulation material (main housing)	Polyphthalamide (PPA GF)
Flammability class per UL94	V0
Clamping spring material	Copper alloy
Contact material	Copper alloy
Contact Plating	Tin
Fire load	0.009 MJ
Weight	0.2 g
MSL per J-STD 020D	1

Environmental requirements

Limit temperature range	-60 ... +105 °C
-------------------------	-----------------

Commercial data

PU (SPU)	13500 (1500) pcs
Packaging type	Box
Country of origin	CH
GTIN	4055143888325
Customs tariff number	85369010000

Product Classification

UNSPSC	39121409
eCl@ss 10.0	27-14-11-06
eCl@ss 9.0	27-14-11-06
ETIM 9.0	EC001284
ETIM 10.0	EC001284
ECCN	NO US CLASSIFICATION

Environmental Product Compliance

RoHS Compliance Status	Compliant, No Exemption
------------------------	-------------------------

Approvals / Certificates

General approvals



Approval	Standard	Certificate Name
CCA DEKRA Certification B.V.	EN 60838	NTR NL 2168246
CCA DEKRA Certification B.V.	EN 60947-7-4	NTR NL-7843/1
cURus Underwriters Laboratories Inc.	UL 1977	E45171
KEMA/KEUR DEKRA Certification B.V.	EN 60838	2168246.01

General approvals

KEMA/KEUR DEKRA Certification B.V.	EN 60947	71-108183
KEMA/KEUR DEKRA Certification B.V.	EN 60998	71-109040
KEMA/KEUR DEKRA Certification B.V.	EN 60947-7-4	71-114208
UL Underwriters Laboratories Inc.	UL 1059	E45172

Declarations of conformity and manufacturer's declarations

Approval	Standard	Certificate Name
EU-Declaration of Confor- mity WAGO GmbH & Co. KG	-	-
UK-Declaration of Confor- mity WAGO GmbH & Co. KG	-	-

Downloads

Environmental Product Compliance

Compliance Search
Environmental Product Compliance 2060-471/998-404 

Documentation



Additional Information
Technical Section 03.04.2019 pdf 2027.26 KB 

CAD/CAE-Data

CAD data
2D/3D Models 2060-471/998-404 

CAE data
ZUKEN Portal 2060-471/998-404 

PCB Design

Symbol and Footprint via SamacSys 2060-471/998-404 
Symbol and Footprint via Ultra Librarian 2060-471/998-404 

1 Compatible Products

1.1 Optional Accessories

1.1.1 Board-to-board link

1.1.1.1 Board-to-board link



Item No.: 2060-951/028-000
Board-to-Board Link; Pin spacing 4 mm; 1-
pole; Length: 28 mm; white

1.1.2 Ferrule

1.1.2.1 Ferrule



Item No.: 216-301

Ferrule; Sleeve for 0.25 mm² / AWG 24; insulated; electro-tin plated; yellow



Item No.: 216-131

Ferrule; Sleeve for 0.25 mm² / AWG 24; uninsulated; electro-tin plated; silver-colored



Item No.: 216-302

Ferrule; Sleeve for 0.34 mm² / 22 AWG; insulated; electro-tin plated; light turquoise



Item No.: 216-132

Ferrule; Sleeve for 0.34 mm² / AWG 24; uninsulated; electro-tin plated

1.1.3 Tool

1.1.3.1 Operating tool



Item No.: 206-860

Operating tool; for 2060 Series; multicoloured



Item No.: 2060-189

Operating tool; made of insulating material; for 2060 Series; white

Installation Notes

Conductor termination



Insert solid conductors via push-in termination.

Conductor termination



Insert/remove fine-stranded conductors by lightly pressing on push-button, e.g., via optional operating tool (206-860).



Terminal blocks can be arranged side-by-side without loss of poles.