

Productinformatieblad

Specificaties



Selector switch flush mounted, plastic, black, Ø30, long handle, 2 positions, stay put, 1 NO

XB5FJ21

EAN Code: 3606481360649

Prijs: 20,05 EUR

Hoofd

range of product	Harmony XB5
product of component type	Keuzeschakelaar
device short name	XB5F
kraag materiaal	Donkergrijs kunststof
koptype	Built-in-flush
bevestigingsdiameter	30,5 mm
verkoop per ondeelbare hoeveelheid	1
vorm van kop signaleringseenheid	Rond
type operator	blijven
operator profiel	Zwart lange hendel, niet gemarkeerd
informatie positie operator	2 standen 90°
type en samenstelling contacten	1 NO
werking contacten	Slow-break
aansluitingen - aansluitklemmen	Schroefklem aansluitingen, <= 2 x 1,5 mm ² met kabeluiteinde In overeenstemming met IEC 60947-1 Schroefklem aansluitingen, >= 1 x 0,22 mm ² zonder kabeluiteinde In overeenstemming met IEC 60947-1

Complementair

hoogte	42 mm
breedte	36,6 mm
diepte	73 mm
beschrijving klemmen ISO n°1	(13-14)NO
weerstand hoge druk drukring	7000000 Pa om 55 °C, afstand: 0.1 m
contact gebruik	Standaardcontacten
positieve opening	Zonder
mechanical durability	1000000 cycles
aanspanmoment	0,8...1,2 N.m In overeenstemming met IEC 60947-1
vorm schroefkop	Kruis compatibel met kruis nr. 1 schroevendraaier Kruis compatibel met pozidriv Nr. 1 schroevendraaier Gegroefd compatibel met vlak Ø 4 mm schroevendraaier Gegroefd compatibel met vlak Ø 5,5 mm schroevendraaier
contact materiaal	Zilverlegering (Ag/Ni)

De weergegeven prijs is de adviesprijs in euro excl. BTW. Deze kan onderhevig zijn aan korting. Neem contact op met uw lokale distributeur of detailhandel voor de daadwerkelijke prijs

kortsluitbeveiliging	10 A smeltpatroon type gG In overeenstemming met IEC 60947-5-1
lth conventionele thermische stroom in vrije lucht	10 A In overeenstemming met IEC 60947-5-1
Ui nom isolatiespanning	600 V (vervuilingsgraad) 3) In overeenstemming met IEC 60947-1
Uimp nom. schokgolfspanning	6 kV In overeenstemming met IEC 60947-1
le nom. bedrijfstrom	3 A om 240 V, AC-15, A600 In overeenstemming met IEC 60947-5-1 6 A om 120 V, AC-15, A600 In overeenstemming met IEC 60947-5-1 0,1 A om 600 V, DC-13, Q600 In overeenstemming met IEC 60947-5-1 0,27 A om 250 V, DC-13, Q600 In overeenstemming met IEC 60947-5-1 0,55 A om 125 V, DC-13, Q600 In overeenstemming met IEC 60947-5-1 1,2 A om 600 V, AC-15, A600 In overeenstemming met IEC 60947-5-1
elektrische levensduur	1000000 cycles, AC-15, 2 A om 230 V, gebruiksnelheid <3600 cyc/h, belastingsfactor: 0,5 In overeenstemming met IEC 60947-5-1 appendix C 1000000 cycles, AC-15, 3 A om 120 V, gebruiksnelheid <3600 cyc/h, belastingsfactor: 0,5 In overeenstemming met IEC 60947-5-1 appendix C 1000000 cycles, AC-15, 4 A om 24 V, gebruiksnelheid <3600 cyc/h, belastingsfactor: 0,5 In overeenstemming met IEC 60947-5-1 appendix C 1000000 cycles, DC-13, 0,2 A om 110 V, gebruiksnelheid <3600 cyc/h, belastingsfactor: 0,5 In overeenstemming met IEC 60947-5-1 appendix C 1000000 cycles, DC-13, 0,5 A om 24 V, gebruiksnelheid <3600 cyc/h, belastingsfactor: 0,5 In overeenstemming met IEC 60947-5-1 appendix C
elektrische betrouwbaarheid	$\Lambda < 10\text{exp}(-6)$ om 5 V, 1 mA in propere omgeving In overeenstemming met IEC 60947-5-4 $\Lambda < 10\text{exp}(-8)$ om 17 V, 5 mA in propere omgeving In overeenstemming met IEC 60947-5-4
product presentatie	Compleet product

Omgeving

beschermende behandeling	TH
ambient air temperature for storage	-40...70 °C
omgevingstemperatuur voor werking	-40...70 °C
beschermingsklasse tegen elektrische schokken	Klasse II In overeenstemming met IEC 60536
IP beschermingsgraad	IP66 In overeenstemming met IEC 60529 IP67 IP69 IP69K
Enclosure Type	UL type 4X/13
IK-beschermingsgraad	IK03 In overeenstemming met IEC 50102
standards	IEC 60947-1 UL 508 JIS C8201-5-1 IEC 60947-5-4 IEC 60947-5-1 CSA C22.2 Nr 14 JIS C8201-1
product certifications	UL listed CSA
trilling bestendigheid	5 gn (f= 2...500 Hz) In overeenstemming met IEC 60068-2-6
schokbestendigheid	30 gn (duur = 18 ms) voor halve sinusgolf versnelling In overeenstemming met IEC 60068-2-27 50 gn (duur = 11 ms) voor halve sinusgolf versnelling In overeenstemming met IEC 60068-2-27

Verpakkingseenheid

Eenheidstype van verpakking 1	PCE
Aantal eenheden in verpakking 1	1

verpakking 1 hoogte	8,890 cm
verpakking 1 breedte	5,588 cm
verpakking 1 lengte	4,572 cm
verpakking_1_gewicht	49,900 g

contractuele waarborg

Garantie (in maanden)	18
-----------------------	----

Schneider Electric wil tegen 2050 de Net Zero-status hebben bereikt via partnerschappen in de toeleveringsketen, materialen met een lagere impact en circulariteit via onze doorlopende campagne "Use Better, Use Longer, Use Again" om de levensduur van producten en de recycleerbaarheid te verlengen.

[Uitleg van Environmental Data >](#)

[Hoe evalueren we de duurzaamheid van producten? >](#)

Milieuoetafdruk

Totale levenscyclus ecologische voetafdruk	0.5 kg CO2 eq.
Koolstofvoetafdruk van de fabricagefase [A1–A3]	0.3 kg CO2 eq.
Koolstofvoetafdruk van de distributiefase [A4]	0 kg CO2 eq.
Koolstofvoetafdruk van de installatiefase [A5]	0 kg CO2 eq.
Koolstofvoetafdruk van de gebruiksfase [B2, B3, B4, B6]	0.1 kg CO2 eq.
Koolstofvoetafdruk van de einde-levensfase [C1–C4]	0.1 kg CO2 eq.

Use Better

Materialen en verpakking

Gemiddeld percentage gerecycleerde kunststof	27 %
Gemiddeld percentage gerecycleerd metaal	16 %
Pakket met gerecycleerd karton	Ja
Verpakkingen zonder kunststof	Ja
RoHS-richtlijn van de EU	Conform
REACH-verordening	Referentie bevat geen SVHC boven drempelwaarde

Use Longer

Levensduurverlenging

Reparatie	Nee
Productreparatie-index	A

Use Again

Hervpakken en herfabriceren

Circulair Profiel	Informatie over einde levensduur
Terugname	Ja
WEEE-label	 Het product moet op markten van de Europese Unie worden afgevoerd volgens specifieke afvalinzamelingsregels en mag nooit in een gewone vuilnisbak terechtkomen.

Dimensions Drawings

Dimensions

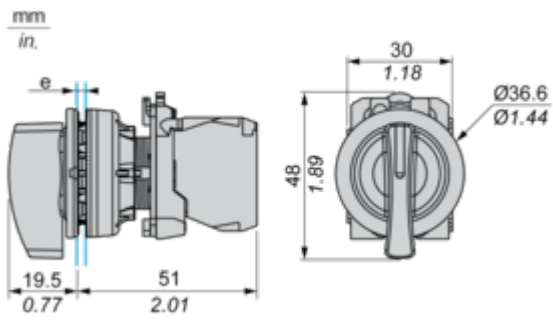

e: Clamping thickness: 1 to 6 mm / 0.04 to 0.24 in.

Mounting and Clearance

Panel Cut-out for Pushbuttons, Switches and Pilot Lights (Finished Holes, Ready for Installation)

Connection by Screw Clamp Terminals or Plug-in Connectors



(1) Diameter on finished panel or support

(2) $\varnothing 30.75 \text{ mm}$ recommended ($\varnothing 30.5 \text{ mm}^{+0.5}_0$) / $\varnothing 1.21 \text{ in.}$ recommended ($\varnothing 1.20 \text{ in.}^{+0.0196}_0$)

Connections	a in mm	a in in.	b in mm	b in in.
By screw clamp terminals or plug-in connector	40	1.57	40	1.57
By Faston connectors	45	1.77	40	1.57

Technical Description

Electrical Composition Corresponding to Code C3



Electrical Composition Corresponding to Code C4



Electrical Composition Corresponding to Code C5

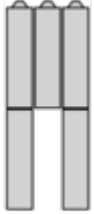

Electrical Composition Corresponding to Code C6



Electrical Composition Corresponding to Code C7

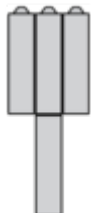

Electrical Composition Corresponding to Code C8

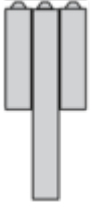

Electrical Composition Corresponding to Codes C9, C11, SF1 and SR1

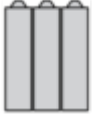

Electrical Composition Corresponding to Code C15

1 N/O

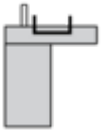

1 N/C



1 N/O + N/C or 1 N/O + N/O or 1 N/C + N/C



Legend

Single contact



Double contact



Light block



Possible location



Sequence of Contacts Fitted to 2-position Selector Switch Body

Position 315°



Push	Position	Top			
		Bottom			
	Location		Left	Centre	Right
	State		0	0	0
	Contacts		N/O	open	open
		N/C	closed	closed	closed

Position 45°







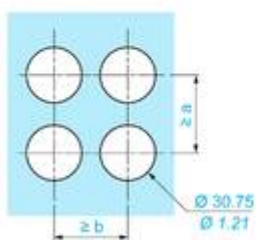
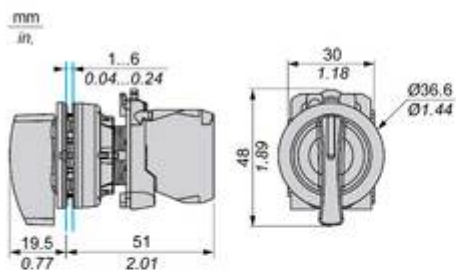

Push	Position	Top			
		Bottom			
	Location		Left	Centre	Right
	State		1	1	1
	Contacts		N/O	closed	closed
		N/C	open	open	open

Technical Illustration

Dimensions



		a (mm)	a (in.)	b (mm)	b (in.)
		40	1.57	40	1.57
ZBE●●●●●	ZBV●●●●●				
		45	1.77	40	1.57
ZBE●●●●●3	ZBV●●●●●3				
		40	1.57	40	1.57
ZBE●●●●●4	ZBV●●●●●4				

Offer Marketing Illustration

Product benefits / Features

The infographic features a central image of three electrical components: a red pushbutton, a green illuminated pushbutton, and a black selector switch. Surrounding this central image are five circular icons, each with a white background and a green symbol. The icons represent: 1) A stylized leaf-like shape for design. 2) A lightning bolt striking a cloud for harsh environments. 3) A hand pointing to a hole for installation. 4) A hand wiping a surface for cleaning. 5) A crossed wrench and screwdriver for installation ease.

Features

Harmony XB4/XB5
Flush mounting solution

- Innovative and attractive design improving the look and feel of control panels and machines
- Robustness to withstand harsh environments
- Quick and easy installation into a standard 30mm hole
- Available for pushbuttons, illuminated pushbuttons, pilot lights and selector switches
- Easier to clean with towels than standard offers

Offer Marketing Illustration

Product benefits / Features



The infographic features a central image of a black and green XB5 terminal block. Surrounding it are five circular icons, each with a corresponding text description of a feature. The background is a solid green color.

Features Harmony XB5

- Quick and easy assembly and disassembly** (Icon: crossed wrench and screwdriver)
- Excellent mechanical connection with operator head** (Icon: hand holding a plug)
- Various types of connection: screw clamp, connector, Faston connector, spring terminal, or printed circuit board** (Icon: screwdriver)
- Large set of accessories to customize your panels** (Icon: plug with a pencil)
- Robustness to withstand harsh environments** (Icon: lightning bolt and rain cloud)

Offer Marketing Illustration

Product benefits / Features

Technical Benefits

Harmony XB5

Conformity with IEC, UL, CSA, CCC EAC, and JIS standards, as well as CE marking and marine approvals

Up to IP66, 67, 69, 69K, and type 4X protection ratings

High vibration resistance with shake-proof terminal screws



Operating temperature from -40°C to 70°C

Shock protection level up to IK06

Secure switching of inductive or heavy DC loads directly – 100 000 operations at 10A, 24V dc

Image of product / Alternate images

Alternative





