

Toestelcontactstop

Bestelnr. 750



- schroefklemmen
- hittebestendig binnenwerk
- vernikkelde contacten

Technische informatie

| | |
|-------------------|--|
| Ampère | 16 A |
| Polen | 7 p |
| Voltage | 400 V |
| Uurstand | 6 h |
| Hertz | 50-60 Hz |
| Aansluittechniek | schroefklemmen |
| Contacten | vernikkelde contacten, hittebestendig binnenwerk |
| Beschermingsgraad | IP 44 |
| Gewicht | 204 g |
| Certificeringen | EAC, CQC |

Tekeningen

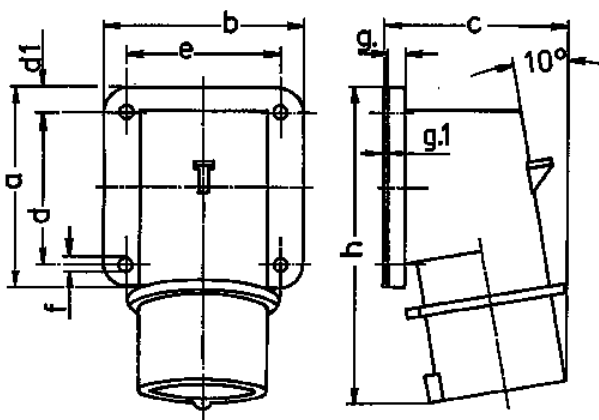

| Tekening | Amp. | 16 | 32 |
|-------------------------|--------------|----------|----------|
| 2 MB 71 | Polen | 7 | 7 |
| Maten in mm | a | 85 | 75 |
| | b | 85 | 90 |
| | c | 79 | 90 |
| | d | 64 | 45 |
| | d1 | 10 | 13 |
| | e | 64 | 78 |
| | f | 5,5 | 5,5 |
| | g. | 6 | 6 |
| | g.1 | 2 | 2 |
| | h | 129 | 138 |
| Kabelaansluiting | | | |
| van/tot mm² | | 1 | 2,5 |
| | | -2,5 | -6 |