

Data Sheet | Item Number: 721-111/027-000

1-conductor female connector; CAGE CLAMP®; 2.5 mm²; Pin spacing 5 mm; 11-pole; 100% protected against mismatching; clamping collar; 2,50 mm²; light gray

<https://www.wago.com/721-111/027-000>

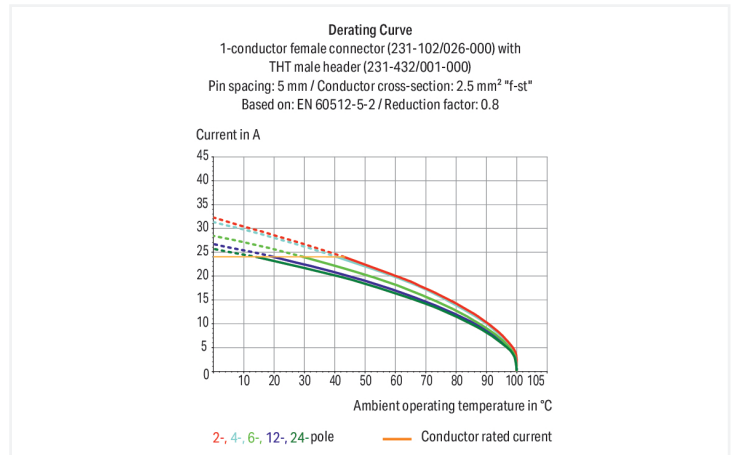
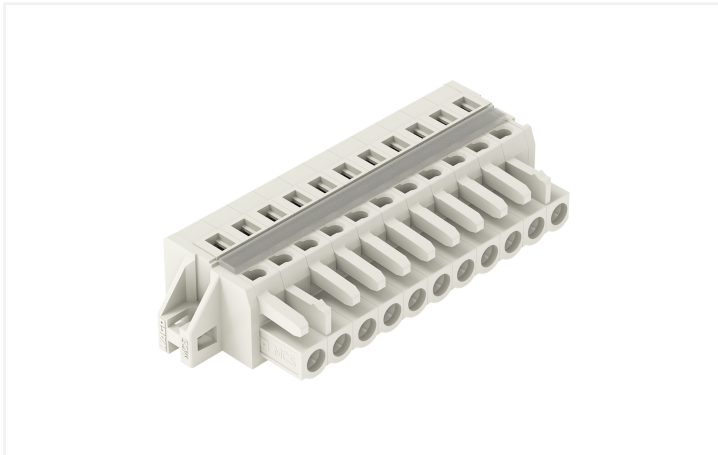

Color: ■ light gray

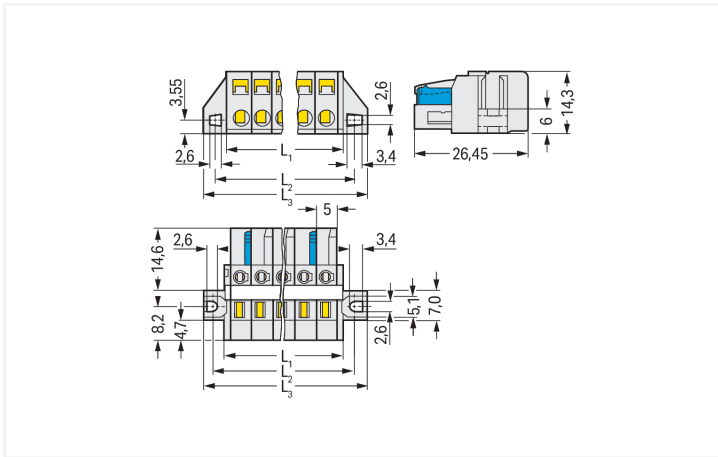

Dimensions in mm

$L1 = (\text{pole no.} \times \text{pin spacing}) + 3 \text{ mm}$
 $L2 = (\text{pole no.} \times \text{pin spacing}) + 8.8 \text{ mm}$
 $L3 = (\text{pole no.} \times \text{pin spacing}) + 14.8 \text{ mm}$
2-pole female connectors – one latch only

Female connector, 721 Series, CAGE CLAMP®

Effortless electrical installations are guaranteed with this female connector (item number 721-111/027-000). Strip lengths must be between 8 and 9 mm when connecting conductors to this female connector. This product features one conductor terminal and utilizes CAGE CLAMP®. Our highly-rated and maintenance-free CAGE CLAMP® connection makes it easy to connect all conductor types without having to prepare the conductor. For example, you don't need to crimp ferrules. The item's dimensions are (69.8 x 14.3 x 26.45) mm (width x height x depth). Depending on the type of conductor, this female connector is suitable for conductor cross sections ranging from 0.08 mm² to 2.5 mm².

Tin is used for coating the contact surfaces.

Notes

Safety Information

The MCS – MULTI CONNECTION SYSTEM includes connectors without breaking capacity in accordance with DIN EN 61984. When used as intended, these connectors must not be connected/disconnected when live or under load. When used as intended, these connectors must not be connected/disconnected when live or under load. The circuit design should ensure header pins, which can be touched, are not live when unmated.

Variants:

Other pole numbers
Gold-plated or partially gold-plated contact surfaces
Other versions (or variants) can be requested from WAGO Sales or configured at <https://configurator.wago.com/>.

Electrical data

Ratings per	IEC/EN 60664-1			Approvals per	UL 1059		
Overvoltage category	III	III	II	Use group	B	C	D
Pollution degree	3	2	2	Rated voltage	300 V	-	300 V
Nominal voltage	320 V	320 V	630 V	Rated current	15 A	-	10 A
Rated impulse withstand voltage	4 kV	4 kV	4 kV				
Rated current	16 A	16 A	16 A				

Ratings	Approvals per			CSA			
Approvals per	UL 1977			Use group	B	C	D
Rated voltage	600 V			Rated voltage	300 V	-	300 V
Rated current	15 A			Rated current	15 A	-	10 A

Connection Data

Clamping units	11	Connection 1	
Total number of potentials	11	Connection technology	CAGE CLAMP®
Number of connection types	1	Actuation type	Operating tool
Number of levels	1	Actuation direction 1	Operation parallel to conductor entry
		Actuation direction 2	Operation perpendicular to conductor entry
		Solid conductor	0.08 ... 2.5 mm ² / 28 ... 12 AWG
		Fine-stranded conductor	0.08 ... 2.5 mm ² / 28 ... 12 AWG
		Fine-stranded conductor; with insulated ferrule	0.25 ... 1.5 mm ²
		Fine-stranded conductor; with uninsulated ferrule	0.25 ... 2.5 mm ²
		Strip length	8 ... 9 mm / 0.31 ... 0.35 inches
		Pole number	11
		Conductor entry direction to mating direction	0°

Physical data

Pin spacing	5 mm / 0.197 inches
Width	69.8 mm / 2.748 inches
Height	14.3 mm / 0.563 inches
Depth	26.45 mm / 1.041 inches

Mechanical data

Variable coding	Yes
Mounting type	Mounting flange
Mounting type	Feed-through mounting Panel mounting
with reinforcing strips	1
Anti-rotation protection	Yes
Suitable for through-panel applications	Yes

Plug-in connection

Contact type (pluggable connector)	Female connector/socket
Connector (connection type)	for conductor
Mismating protection	Yes

Material data

Note (material data)	Information on material specifications can be found here
Color	light gray
Material group	I
Insulation material (main housing)	Polyamide (PA66)
Flammability class per UL94	V0
Clamping spring material	Chrome-nickel spring steel (CrNi)
Contact material	Copper alloy
Contact Plating	Tin
Fire load	0.297 MJ
Weight	20.6 g

Environmental requirements

Limit temperature range	-60 ... +100 °C	<h4>Environmental Testing</h4>
Processing temperature	-35 ... +60 °C	
		Test specification: Railway applications – Rolling stock – Electronic equipment
		DIN EN 50155 (VDE 0115-200):2022-06
		Test procedure: Railway applications – Rolling stock equipment – Vibration and shock tests
		DIN EN 61373 (VDE 0115-0106):2011-04
		Spectrum/Mounting location
		Service life test, Category 1, Class A/B
		Functional test with noise-like oscillations
		Test passed according to Section 8 of the standard
		Frequency
		$f_1 = 5 \text{ Hz}$ to $f_2 = 150 \text{ Hz}$
		Acceleration
		0.101g (highest test level used for all axes)
		Test duration per axis
		10 min.
		Test directions
		X, Y and Z axes
		Monitoring of contact faults and interruptions
		Passed
		Voltage drop measurement before and after each axis
		Passed
		Simulated service life test through increased levels of noise-like oscillations
		Test passed according to Section 9 of the standard
		Frequency
		$f_1 = 5 \text{ Hz}$ to $f_2 = 150 \text{ Hz}$
		Acceleration
		0.572g (highest test level used for all axes)
		Test duration per axis
		5 h
		Test directions
		X, Y and Z axes
		Extended testing: Monitoring of contact faults and interruptions
		Passed

Environmental Testing	
Extended testing: Voltage drop measurement before and after each axis	Passed
Shock test	Test passed according to Section 10 of the standard
Shock pulse form	Half sine
Acceleration	5g (highest test level used for all axes)
Shock duration	30 ms
Number of shocks (per axis)	3 pos. und 3 neg.
Test directions	X, Y and Z axes
Extended testing: Monitoring of contact faults and interruptions	Passed
Extended testing: Voltage drop measurement before and after each axis	Passed
Vibration and shock stress for rolling stock equipment	Passed

Commercial data	
Product Group	3 (Multi Conn. System)
PU (SPU)	25 pcs
Packaging type	Box
Country of origin	DE
GTIN	4045454937850
Customs tariff number	85366990990

Product Classification	
UNSPSC	39121409
eCl@ss 10.0	27-44-03-09
eCl@ss 9.0	27-44-03-09
ETIM 9.0	EC002638
ETIM 10.0	EC002638
ECCN	NO US CLASSIFICATION

Environmental Product Compliance	
RoHS Compliance Status	Compliant, No Exemption

Approvals / Certificates

General approvals		
Approval	Standard	Certificate Name
CB DEKRA Certification B.V.	IEC 61984	NL-113351
CSA DEKRA Certification B.V.	C22.2	1466354
KEMA/KEUR DEKRA Certification B.V.	EN 61984	71-130478 REV.1
UL Underwriters Laboratories Inc.	UL 1059	E45172

Declarations of conformity and manufacturer's declarations		
Approval	Standard	Certificate Name
Railway WAGO GmbH & Co. KG	-	Railway Ready

Approvals for marine applications



Approval	Standard	Certificate Name
ABS American Bureau of Ship- ping	-	24-0095975-PDA
BV Bureau Veritas S.A.	IEC 60998	11915/E0 BV
DNV DNV GL SE	-	TAE000016Z
PRS Polski Rejestr Statków	-	TE/1095/880590/23

Downloads

Environmental Product Compliance

Compliance Search
Environmental Product Compliance 721-111/027-000

Documentation

Additional Information			
Technical Section	03.04.2019	pdf 2027.26 KB	

CAD/CAE-Data

CAD data
2D/3D Models 721-111/027-000

CAE data
ZUKEN Portal 721-111/027-000

1 Compatible Products

1.1 System counterpart

1.1.1 Male connector/plug



Item No.: 721-611
1-conductor male connector; CAGE CLAMP®; 2.5 mm²; Pin spacing 5 mm; 11-pole; 100% protected against mismatching; 2,50 mm²; light gray

Item No.: 721-441/001-000
THT male header; 1.0 x 1.0 mm solder pin; angled; 100% protected against mismatching; Pin spacing 5 mm; 11-pole; light gray

Item No.: 721-141/001-000
THT male header; 1.0 x 1.0 mm solder pin; straight; 100% protected against mismatching; Pin spacing 5 mm; 11-pole; light gray

1.2 Optional Accessories

1.2.1 Cover

1.2.1.1 Cover



Item No.: 231-668

Lockout caps; for covering unused clamping units; gray



Item No.: 231-669

Lockout caps; for covering unused clamping units; orange

1.2.2 Ferrule

1.2.2.1 Ferrule



Item No.: 216-301

Ferrule; Sleeve for 0.25 mm² / AWG 24; insulated; electro-tin plated; yellow



Item No.: 216-302

Ferrule; Sleeve for 0.34 mm² / 22 AWG; insulated; electro-tin plated; light turquoise



Item No.: 216-201

Ferrule; Sleeve for 0.5 mm² / 20 AWG; insulated; electro-tin plated; electrolytic copper; acc. to DIN 46228, Part 4/09.90; white



Item No.: 216-241

Ferrule; Sleeve for 0.5 mm² / 20 AWG; insulated; electro-tin plated; electrolytic copper; gastight crimped; acc. to DIN 46228, Part 4/09.90; white



Item No.: 216-141

Ferrule; Sleeve for 0.5 mm² / 20 AWG; un-insulated; electro-tin plated; electrolytic copper; gastight crimped; acc. to DIN 46228, Part 1/08.92



Item No.: 216-101

Ferrule; Sleeve for 0.5 mm² / AWG 22; un-insulated; electro-tin plated; silver-colored



Item No.: 216-242

Ferrule; Sleeve for 0.75 mm² / 18 AWG; insulated; electro-tin plated; electrolytic copper; gastight crimped; acc. to DIN 46228, Part 4/09.90; gray



Item No.: 216-262

Ferrule; Sleeve for 0.75 mm² / 18 AWG; insulated; electro-tin plated; electrolytic copper; gastight crimped; acc. to DIN 46228, Part 4/09.90; gray



Item No.: 216-202

Ferrule; Sleeve for 0.75 mm² / 18 AWG; insulated; electro-tin plated; gray



Item No.: 216-142

Ferrule; Sleeve for 0.75 mm² / 18 AWG; un-insulated; electro-tin plated; electrolytic copper; gastight crimped; acc. to DIN 46228, Part 1/08.92



Item No.: 216-102

Ferrule; Sleeve for 0.75 mm² / AWG 20; un-insulated; electro-tin plated; silver-colored



Item No.: 216-243

Ferrule; Sleeve for 1 mm² / AWG 18; insulated; electro-tin plated; electrolytic copper; gastight crimped; acc. to DIN 46228, Part 4/09.90; red



Item No.: 216-263

Ferrule; Sleeve for 1 mm² / AWG 18; insulated; electro-tin plated; electrolytic copper; gastight crimped; acc. to DIN 46228, Part 4/09.90; red



Item No.: 216-203

Ferrule; Sleeve for 1 mm² / AWG 18; insulated; electro-tin plated; red



Item No.: 216-103

Ferrule; Sleeve for 1 mm² / AWG 18; un-insulated; electro-tin plated



Item No.: 216-143

Ferrule; Sleeve for 1 mm² / AWG 18; un-insulated; electro-tin plated; electrolytic copper; gastight crimped; acc. to DIN 46228, Part 1/08.92



Item No.: 216-204

Ferrule; Sleeve for 1.5 mm² / AWG 16; insulated; electro-tin plated; black



Item No.: 216-244

Ferrule; Sleeve for 1.5 mm² / AWG 16; insulated; electro-tin plated; electrolytic copper; gastight crimped; acc. to DIN 46228, Part 4/09.90; black



Item No.: 216-264

Ferrule; Sleeve for 1.5 mm² / AWG 16; insulated; electro-tin plated; electrolytic copper; gastight crimped; acc. to DIN 46228, Part 4/09.90; black



Item No.: 216-284

Ferrule; Sleeve for 1.5 mm² / AWG 16; insulated; electro-tin plated; electrolytic copper; gastight crimped; acc. to DIN 46228, Part 4/09.90; black



Item No.: 216-144

Ferrule; Sleeve for 1.5 mm² / AWG 16; un-insulated; electro-tin plated; electrolytic copper; gastight crimped; acc. to DIN 46228, Part 1/08.92; silver-colored



Item No.: 216-104

Ferrule; Sleeve for 1.5 mm² / AWG 16; un-insulated; electro-tin plated; silver-colored



Item No.: 216-106

Ferrule; Sleeve for 2.5 mm² / AWG 14; un-insulated; electro-tin plated; silver-colored

1.2.3 Insulation stop

1.2.3.1 Insulation stop



Item No.: 231-670

Insulation stop; 0.08-0.2 mm² / 0.2 mm² "s"; white



Item No.: 231-671

Insulation stop; 0.25 - 0.5 mm²; light gray



Item No.: 231-672

Insulation stop; 0.75 - 1 mm²; dark gray

1.2.4 Jumper

1.2.4.1 Jumper



Item No.: 231-910

Jumper; for conductor entry; 10-way; insulated; gray



Item No.: 231-902

Jumper; for conductor entry; 2-way; insulated; gray



Item No.: 231-903

Jumper; for conductor entry; 3-way; insulated; gray



Item No.: 231-905

Jumper; for conductor entry; 5-way; insulated; gray



Item No.: 231-907

Jumper; for conductor entry; 7-way; insulated; gray

1.2.5 Marking

1.2.5.1 Marking strip



Item No.: 210-331/500-103

Marking strips; as a DIN A4 sheet; MARKED; 1-12 (300x); Height of marker strip: 2.3 mm/0.091 in; Strip length 182 mm; Horizontal marking; Self-adhesive; white



Item No.: 210-332/500-202

Marking strips; as a DIN A4 sheet; MARKED; 1-16 (160x); Height of marker strip: 3 mm; Strip length 182 mm; Horizontal marking; Self-adhesive; white



Item No.: 210-332/500-205

Marking strips; as a DIN A4 sheet; MARKED; 1-32 (80x); Height of marker strip: 3 mm; Strip length 182 mm; Horizontal marking; Self-adhesive; white



Item No.: 210-331/500-104

Marking strips; as a DIN A4 sheet; MARKED; 13-24 (300x); Height of marker strip: 2.3 mm/0.091 in; Strip length 182 mm; Horizontal marking; Self-adhesive; white



Item No.: 210-332/500-204

Marking strips; as a DIN A4 sheet; MARKED; 17-32 (160x); Height of marker strip: 3 mm; Strip length 182 mm; Horizontal marking; Self-adhesive; white



Item No.: 210-332/500-206

Marking strips; as a DIN A4 sheet; MARKED; 33-48 (160x); Height of marker strip: 3 mm; Strip length 182 mm; Horizontal marking; Self-adhesive; white

1.2.6 Strain relief

1.2.6.1 Strain relief housing



Item No.: 232-610

Strain relief housing; for female and male connectors; 2 parts; Pin spacing 5 mm; 10-pole; gray

1.2.7 Test and measurement

1.2.7.1 Testing accessories



Item No.: 210-136

Test plug; 2 mm Ø; with 500 mm cable; red

Item No.: 231-661

Test plugs for female connectors; for 5 mm and 5.08 mm pin spacing; 2,50 mm²; light gray

1.2.8 Tool

1.2.8.1 Operating tool



Item No.: 209-132

Operating tool; for connecting comb-style jumper bar; made of insulating material; 2-way; natural



Item No.: 280-440

Operating tool; made of insulating material; 10-way; white



Item No.: 209-130

Operating tool; made of insulating material; 1-way; for 264 Series (1-/2-way), 280, 281 Series (up to 3-way); natural



Item No.: 231-291

Operating tool; made of insulating material; 1-way; loose; red



Item No.: 231-131

Operating tool; made of insulating material; 1-way; loose; white



Item No.: 280-432

Operating tool; made of insulating material; 2-way; white



Item No.: 280-433

Operating tool; made of insulating material; 3-way; white



Item No.: 280-434

Operating tool; made of insulating material; 4-way; white



Item No.: 280-435

Operating tool; made of insulating material; 5-way; gray



Item No.: 280-436

Operating tool; made of insulating material; 6-way; white



Item No.: 280-437

Operating tool; made of insulating material; 7-way; white



Item No.: 280-438

Operating tool; made of insulating material; 8-way; white

Installation Notes

Conductor termination

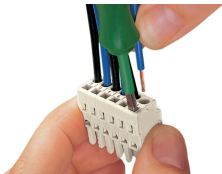

Inserting a conductor via 3.5 mm screwdriver – CAGE CLAMP® actuation parallel to conductor entry.

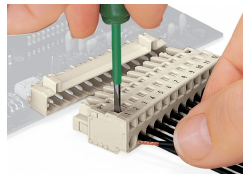

Inserting a conductor via 3.5 mm screwdriver – CAGE CLAMP® actuation perpendicular to conductor entry.

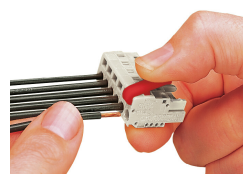

Inserting a conductor via operating tool.

Coding



Coding a female connector by removing coding finger(s).

Testing

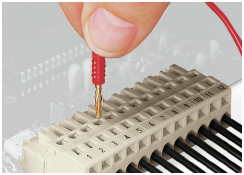

Testing perpendicular to conductor entry with 2 or 2.3 mm Ø test plug – female connector with CAGE CLAMP® – via integrated test ports

Installation



Male connector with strain relief plate



Strain relief housing shown with a male connector equipped with CAGE CLAMP®