

# Data Sheet | Item Number: 721-609/019-000

1-conductor male connector; CAGE CLAMP®; 2.5 mm<sup>2</sup>; Pin spacing 5 mm; 9-pole;  
100% protected against mismatching; clamping collar; 2,50 mm<sup>2</sup>; light gray

<https://www.wago.com/721-609/019-000>



Color: ■ light gray

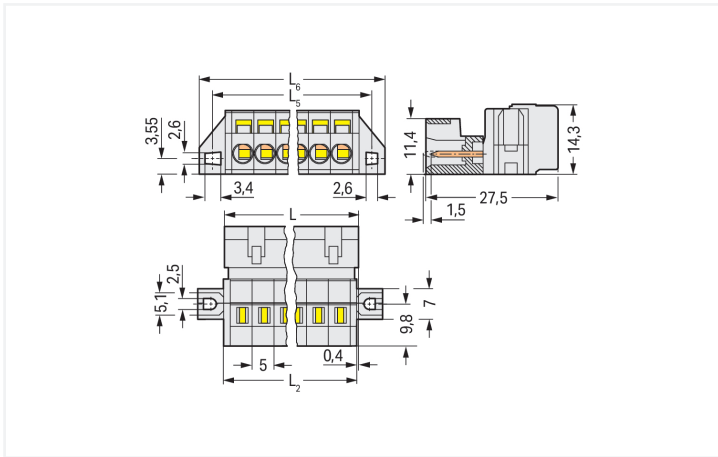

Dimensions in mm

$L = (\text{pole no.} - 1) \times \text{pin spacing} + 8.2 \text{ mm}$   
 $L_2 = L - 0.2 \text{ mm}$   
 $L_5 = L_2 + 5.8 \text{ mm}$   
 $L_6 = L_2 + 11.8 \text{ mm}$

## Male connector, 721 Series, CAGE CLAMP®

Our male connector (item number 721-609/019-000) simplifies electrical installations. Strip lengths must be between 8 and 9 mm when connecting conductors to this male connector. Featuring one conductor terminal along with CAGE CLAMP®, this product outperforms the competition. Our highly-rated and maintenance-free CAGE CLAMP® connection makes it easy to connect all conductor types without having to prepare the conductor. For example, you don't need to crimp ferrules. The dimensions are (59.8 x 14.3 x 27.5) mm (width x height x depth). This male connector is suitable for conductor cross sections ranging from 0.08 mm<sup>2</sup> to 2.5 mm<sup>2</sup>.

Tin is used for coating the contact surfaces.

## Notes

## Safety Information

The MCS – MULTI CONNECTION SYSTEM includes connectors without breaking capacity in accordance with DIN EN 61984. When used as intended, these connectors must not be connected/disconnected when live or under load. When used as intended, these connectors must not be connected/disconnected when live or under load. The circuit design should ensure header pins, which can be touched, are not live when unmated.

## Variants:

Other pole numbers  
Gold-plated or partially gold-plated contact surfaces  
Other versions (or variants) can be requested from WAGO Sales or configured at <https://configurator.wago.com/>.

## Electrical data

Ratings per IEC/EN 60664-1				Approvals per UL 1059			
	III	III	II	Use group	B	C	D
Overvoltage category	III	III	II	Rated voltage	300 V	-	300 V
Pollution degree	3	2	2	Rated current	15 A	-	10 A
Nominal voltage	320 V	320 V	630 V				
Rated impulse withstand voltage	4 kV	4 kV	4 kV				
Rated current	12 A	12 A	12 A				

Approvals per UL 1977	
Rated voltage	600 V
Rated current	15 A

Approvals per CSA			
Use group	B	C	D
Rated voltage	300 V	-	300 V
Rated current	15 A	-	10 A

## Connection Data

Clamping units	9
Total number of potentials	9
Number of connection types	1
Number of levels	1

## Connection 1

Connection technology	CAGE CLAMP®
Actuation type	Operating tool
Actuation direction 1	Operation parallel to conductor entry
Actuation direction 2	Operation perpendicular to conductor entry
Solid conductor	0.08 ... 2.5 mm <sup>2</sup> / 28 ... 12 AWG
Fine-stranded conductor	0.08 ... 2.5 mm <sup>2</sup> / 28 ... 12 AWG
Fine-stranded conductor; with insulated ferrule	0.25 ... 1.5 mm <sup>2</sup>
Fine-stranded conductor; with uninsulated ferrule	0.25 ... 2.5 mm <sup>2</sup>
Strip length	8 ... 9 mm / 0.31 ... 0.35 inches
Pole number	9
Conductor entry direction to mating direction	0°

## Physical data

Pin spacing	5 mm / 0.197 inches
Width	59.8 mm / 2.354 inches
Height	14.3 mm / 0.563 inches
Depth	27.5 mm / 1.083 inches

### Mechanical data

Variable coding	Yes
Direct ground contact to DIN-rail/drilled hole/housing	No
Mounting type	Mounting flange
Mounting type	Feed-through mounting Panel mounting
Anti-rotation protection	Yes
Suitable for through-panel applications	Yes

### Plug-in connection

Contact type (pluggable connector)	Male connector/plug
Connector (connection type)	for conductor
Mismating protection	Yes

### Material data

Note (material data)	<a href="#">Information on material specifications can be found here</a>
Color	light gray
Material group	I
Insulation material (main housing)	Polyamide (PA66)
Flammability class per UL94	V0
Clamping spring material	Chrome-nickel spring steel (CrNi)
Contact material	Electrolytic copper (E <sub>Cu</sub> )
Contact Plating	Tin
Fire load	0.266 MJ
Weight	14.7 g

### Environmental requirements

Limit temperature range	-60 ... +100 °C	<b>Environmental Testing</b>	
Processing temperature	-35 ... +60 °C	Test specification: Railway applications – Rolling stock – Electronic equipment	DIN EN 50155 (VDE 0115-200):2022-06
		Test procedure: Railway applications – Rolling stock equipment – Vibration and shock tests	DIN EN 61373 (VDE 0115-0106):2011-04
		Spectrum/Mounting location	Service life test, Category 1, Class A/B
		Functional test with noise-like oscillations	Test passed according to Section 8 of the standard
		Frequency	f <sub>1</sub> = 5 Hz to f <sub>2</sub> = 150 Hz
		Acceleration	0.101g (highest test level used for all axes)
		Test duration per axis	10 min.
		Test directions	X, Y and Z axes
		Monitoring of contact faults and interruptions	Passed
		Voltage drop measurement before and after each axis	Passed
		Simulated service life test through increased levels of noise-like oscillations	Test passed according to Section 9 of the standard
		Frequency	f <sub>1</sub> = 5 Hz to f <sub>2</sub> = 150 Hz
		Acceleration	0.572g (highest test level used for all axes)
		Test duration per axis	5 h
		Test directions	X, Y and Z axes
		Extended testing: Monitoring of contact faults and interruptions	Passed

### Environmental Testing

Extended testing: Voltage drop measurement before and after each axis	Passed
Shock test	Test passed according to Section 10 of the standard
Shock pulse form	Half sine
Acceleration	5g (highest test level used for all axes)
Shock duration	30 ms
Number of shocks (per axis)	3 pos. und 3 neg.
Test directions	X, Y and Z axes
Extended testing: Monitoring of contact faults and interruptions	Passed
Extended testing: Voltage drop measurement before and after each axis	Passed
Vibration and shock stress for rolling stock equipment	Passed

### Commercial data

Product Group	3 (Multi Conn. System)
PU (SPU)	25 pcs
Packaging type	Box
Country of origin	DE
GTIN	4044918263863
Customs tariff number	85366930000

### Product Classification

UNSPSC	39121409
eCl@ss 10.0	27-44-03-09
eCl@ss 9.0	27-44-03-09
ETIM 9.0	EC002638
ETIM 10.0	EC002638
ECCN	NO US CLASSIFICATION

### Environmental Product Compliance

RoHS Compliance Status	Compliant, No Exemption
------------------------	-------------------------

### Approvals / Certificates

#### General approvals



Approval	Standard	Certificate Name
CB DEKRA Certification B.V.	IEC 61984	NL-113351
CSA DEKRA Certification B.V.	C22.2	1466354
KEMA/KEUR DEKRA Certification B.V.	EN 61984	71-130478 REV.1
UL Underwriters Laboratories Inc.	UL 1059	E45172
UR Underwriters Laboratories Inc.	UL 1977	E45171

#### Declarations of conformity and manufacturer's declarations



Approval	Standard	Certificate Name
Railway WAGO GmbH & Co. KG	-	Railway Ready

Approvals for marine applications



Approval	Standard	Certificate Name
ABS American Bureau of Ship- ping	-	24-0095975-PDA
DNV DNV GL SE	-	TAE000016Z
PRS Polski Rejestr Statków	-	TE/1095/880590/23

Downloads

Environmental Product Compliance

Compliance Search
Environmental Product Compliance 721-609/019-000

Documentation

Additional Information
Technical Section 03.04.2019 pdf 2027.26 KB

CAD/CAE-Data

CAD data
2D/3D Models 721-609/019-000

CAE data
EPLAN Data Portal 721-609/019-000
ZUKEN Portal 721-609/019-000

1 Compatible Products

1.1 System counterpart

1.1.1 Female connector/socket



**Item No.: 721-109/026-000**  
1-conductor female connector; CAGE CLAMP®; 2.5 mm<sup>2</sup>; Pin spacing 5 mm; 9-pole; 100% protected against mismatching; 2,50 mm<sup>2</sup>; light gray



**Item No.: 722-239**  
THT female header; angled; Pin spacing 5 mm; 9-pole; 100% protected against mismatching; 0.6 x 1.0 mm solder pin; light gray



**Item No.: 722-139**  
THT female header; straight; Pin spacing 5 mm; 9-pole; 100% protected against mismatching; 0.6 x 1.0 mm solder pin; light gray

1.2 Optional Accessories

1.2.1 Coding

1.2.1.1 Coding



**Item No.: 231-129**

Coding key; snap-on type; light gray

1.2.2 Cover

1.2.2.1 Cover



**Item No.: 231-668**

Lockout caps; for covering unused clamping units; gray

1.2.3 Ferrule

1.2.3.1 Ferrule



**Item No.: 216-301**

Ferrule; Sleeve for 0.25 mm<sup>2</sup> / AWG 24; insulated; electro-tin plated; yellow



**Item No.: 216-302**

Ferrule; Sleeve for 0.34 mm<sup>2</sup> / 22 AWG; insulated; electro-tin plated; light turquoise



**Item No.: 216-201**

Ferrule; Sleeve for 0.5 mm<sup>2</sup> / 20 AWG; insulated; electro-tin plated; electrolytic copper; acc. to DIN 46228, Part 4/09.90; white



**Item No.: 216-241**

Ferrule; Sleeve for 0.5 mm<sup>2</sup> / 20 AWG; insulated; electro-tin plated; electrolytic copper; gastight crimped; acc. to DIN 46228, Part 4/09.90; white



**Item No.: 216-141**

Ferrule; Sleeve for 0.5 mm<sup>2</sup> / 20 AWG; un-insulated; electro-tin plated; electrolytic copper; gastight crimped; acc. to DIN 46228, Part 1/08.92



**Item No.: 216-101**

Ferrule; Sleeve for 0.5 mm<sup>2</sup> / AWG 22; un-insulated; electro-tin plated; silver-colored



**Item No.: 216-242**

Ferrule; Sleeve for 0.75 mm<sup>2</sup> / 18 AWG; insulated; electro-tin plated; electrolytic copper; gastight crimped; acc. to DIN 46228, Part 4/09.90; gray



**Item No.: 216-262**

Ferrule; Sleeve for 0.75 mm<sup>2</sup> / 18 AWG; insulated; electro-tin plated; electrolytic copper; gastight crimped; acc. to DIN 46228, Part 4/09.90; gray



**Item No.: 216-202**

Ferrule; Sleeve for 0.75 mm<sup>2</sup> / 18 AWG; insulated; electro-tin plated; gray



**Item No.: 216-142**

Ferrule; Sleeve for 0.75 mm<sup>2</sup> / 18 AWG; un-insulated; electro-tin plated; electrolytic copper; gastight crimped; acc. to DIN 46228, Part 1/08.92



**Item No.: 216-102**

Ferrule; Sleeve for 0.75 mm<sup>2</sup> / AWG 20; un-insulated; electro-tin plated; silver-colored



**Item No.: 216-243**

Ferrule; Sleeve for 1 mm<sup>2</sup> / AWG 18; insulated; electro-tin plated; electrolytic copper; gastight crimped; acc. to DIN 46228, Part 4/09.90; red



**Item No.: 216-263**

Ferrule; Sleeve for 1 mm<sup>2</sup> / AWG 18; insulated; electro-tin plated; electrolytic copper; gastight crimped; acc. to DIN 46228, Part 4/09.90; red



**Item No.: 216-203**

Ferrule; Sleeve for 1 mm<sup>2</sup> / AWG 18; insulated; electro-tin plated; red



**Item No.: 216-103**

Ferrule; Sleeve for 1 mm<sup>2</sup> / AWG 18; un-insulated; electro-tin plated



**Item No.: 216-143**

Ferrule; Sleeve for 1 mm<sup>2</sup> / AWG 18; un-insulated; electro-tin plated; electrolytic copper; gastight crimped; acc. to DIN 46228, Part 1/08.92



**Item No.: 216-204**

Ferrule; Sleeve for 1.5 mm<sup>2</sup> / AWG 16; insulated; electro-tin plated; black



**Item No.: 216-244**

Ferrule; Sleeve for 1.5 mm<sup>2</sup> / AWG 16; insulated; electro-tin plated; electrolytic copper; gastight crimped; acc. to DIN 46228, Part 4/09.90; black



**Item No.: 216-264**

Ferrule; Sleeve for 1.5 mm<sup>2</sup> / AWG 16; insulated; electro-tin plated; electrolytic copper; gastight crimped; acc. to DIN 46228, Part 4/09.90; black



**Item No.: 216-284**

Ferrule; Sleeve for 1.5 mm<sup>2</sup> / AWG 16; insulated; electro-tin plated; electrolytic copper; gastight crimped; acc. to DIN 46228, Part 4/09.90; black



**Item No.: 216-144**

Ferrule; Sleeve for 1.5 mm<sup>2</sup> / AWG 16; un-insulated; electro-tin plated; electrolytic copper; gastight crimped; acc. to DIN 46228, Part 1/08.92; silver-colored



**Item No.: 216-104**

Ferrule; Sleeve for 1.5 mm<sup>2</sup> / AWG 16; un-insulated; electro-tin plated; silver-colored



**Item No.: 216-106**

Ferrule; Sleeve for 2.5 mm<sup>2</sup> / AWG 14; un-insulated; electro-tin plated; silver-colored

## 1.2.4 Installation

### 1.2.4.1 Mounting accessories



**Item No.: 231-295**  
Screw with nut



**Item No.: 231-195**  
Screw with nut; M2x12; for fixing element



**Item No.: 209-147**  
Self-tapping screw



**Item No.: 231-194**  
Self-tapping screw; B 2.2x13, fixing hole 1.8 mm Ø

## 1.2.5 Insulation stop

### 1.2.5.1 Insulation stop



**Item No.: 231-670**  
Insulation stop; 0.08-0.2 mm<sup>2</sup> / 0.2 mm<sup>2</sup> "s"; white



**Item No.: 231-671**  
Insulation stop; 0.25 - 0.5 mm<sup>2</sup>; light gray



**Item No.: 231-672**  
Insulation stop; 0.75 - 1 mm<sup>2</sup>; dark gray

## 1.2.6 Jumper

### 1.2.6.1 Jumper



**Item No.: 231-902**  
Jumper; for conductor entry; 2-way; insulated; gray



**Item No.: 231-903**  
Jumper; for conductor entry; 3-way; insulated; gray



**Item No.: 231-905**  
Jumper; for conductor entry; 5-way; insulated; gray



**Item No.: 231-907**  
Jumper; for conductor entry; 7-way; insulated; gray

## 1.2.7 Marking

### 1.2.7.1 Marking strip



**Item No.: 210-331/500-103**  
Marking strips; as a DIN A4 sheet; MARKED; 1-12 (300x); Height of marker strip: 2.3 mm/0.091 in; Strip length 182 mm; Horizontal marking; Self-adhesive; white



**Item No.: 210-332/500-202**  
Marking strips; as a DIN A4 sheet; MARKED; 1-16 (160x); Height of marker strip: 3 mm; Strip length 182 mm; Horizontal marking; Self-adhesive; white



**Item No.: 210-332/500-205**  
Marking strips; as a DIN A4 sheet; MARKED; 1-32 (80x); Height of marker strip: 3 mm; Strip length 182 mm; Horizontal marking; Self-adhesive; white



**Item No.: 210-331/500-104**  
Marking strips; as a DIN A4 sheet; MARKED; 13-24 (300x); Height of marker strip: 2.3 mm/0.091 in; Strip length 182 mm; Horizontal marking; Self-adhesive; white



**Item No.: 210-332/500-204**  
Marking strips; as a DIN A4 sheet; MARKED; 17-32 (160x); Height of marker strip: 3 mm; Strip length 182 mm; Horizontal marking; Self-adhesive; white



**Item No.: 210-332/500-206**  
Marking strips; as a DIN A4 sheet; MARKED; 33-48 (160x); Height of marker strip: 3 mm; Strip length 182 mm; Horizontal marking; Self-adhesive; white

## 1.2.8 Strain relief

### 1.2.8.1 Strain relief housing



**Item No.: 232-609**

Strain relief housing; for female and male connectors; 2 parts; Pin spacing 5 mm; 9-pole; gray

## 1.2.9 Tool

### 1.2.9.1 Operating tool



**Item No.: 231-231**

Combination operating tool; red



**Item No.: 210-720**

Operating tool; Blade: 3.5 x 0.5 mm; with a partially insulated shaft; multicoloured



**Item No.: 210-657**

Operating tool; Blade: 3.5 x 0.5 mm; with a partially insulated shaft; short; multicoloured



**Item No.: 209-130**

Operating tool; made of insulating material; 1-way; for 264 Series (1-1/2-way), 280, 281 Series (up to 3-way); natural



**Item No.: 231-291**

Operating tool; made of insulating material; 1-way; loose; red



**Item No.: 231-131**

Operating tool; made of insulating material; 1-way; loose; white



**Item No.: 280-432**

Operating tool; made of insulating material; 2-way; white



**Item No.: 280-433**

Operating tool; made of insulating material; 3-way; white



**Item No.: 280-434**

Operating tool; made of insulating material; 4-way; white



**Item No.: 280-435**

Operating tool; made of insulating material; 5-way; gray



**Item No.: 280-436**

Operating tool; made of insulating material; 6-way; white



**Item No.: 280-437**

Operating tool; made of insulating material; 7-way; white



**Item No.: 280-438**

Operating tool; made of insulating material; 8-way; white



**Item No.: 231-159**

Operating tool; natural

## Installation Notes

### Conductor termination

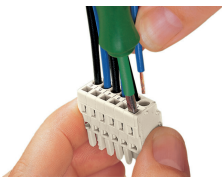

Inserting a conductor via 3.5 mm screwdriver – CAGE CLAMP® actuation parallel to conductor entry.

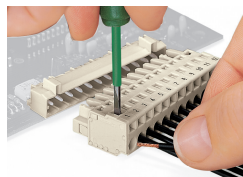

Inserting a conductor via 3.5 mm screwdriver – CAGE CLAMP® actuation perpendicular to conductor entry.

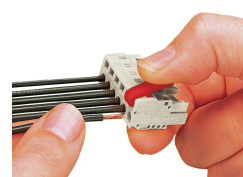

Inserting a conductor via operating tool.

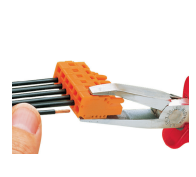

## Testing

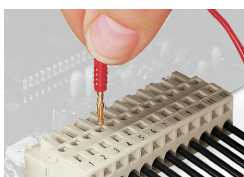

Testing perpendicular to conductor entry with 2 or 2.3 mm Ø test plug – female connector with CAGE CLAMP® – via integrated test ports

## Installation



Male connector with strain relief plate

Strain relief housing shown with a male connector equipped with CAGE CLAMP®

## Coding

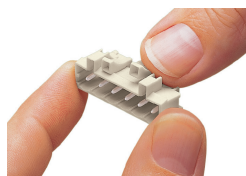

Coding a male header – fitting coding key (s).