

# Productinformatieblad

Specificaties



## Harmony XB5, Kop drukknop, Drukdraaiantgr., Ø22mm, Dom 4A185, Zwart

ZB5AFDA

EAN Code: 3389110905403

**Prijs: 43,90 EUR**

### Hoofd

range of product	Harmony XB5
product of component type	Kop voor niet-verlichte drukknop
device short name	ZB5
kraag materiaal	Donkergrijs kunststof
bevestigingsdiameter	22 mm
koptype	Standaard
verkoop per ondeelbare hoeveelheid	1
vorm van kop signaleringseenheid	Rond
type operator	draaien voor ontgrendelen
operator profiel	sleutelschakelaar
type slot met sleutel	Dom 4A185
terugtrekpositie sleutel	Beide posities
positie vergrendeling	Beide posities

### Complementair

CAD totale breedte	29 mm
CAD totale hoogte	29 mm
CAD totale diepte	62 mm
gewicht product	0,05 kg
mechanical durability	500000 cycles
naam station	XALD 1...5 uitsnijdingen XALK 2...5 uitsnijdingen
elektrische samenstellingscode	C12 voor <6 contacten gebruik enkelvoudig blokken in vooraan gemonteerd C15 voor <1 contacten gebruik enkelvoudig blokken in vooraan gemonteerd SF1 voor <3 contacten gebruik enkelvoudig blokken in vooraan gemonteerd SR1 voor <3 contacten gebruik enkelvoudig blokken in montage aan achterzijde C13 voor <6 contacten gebruik enkelvoudig en dubbel blokken in vooraan gemonteerd

### Omgeving

beschermende behandeling	TH
ambient air temperature for storage	-40...70 °C
omgevingstemperatuur voor werking	-25...70 °C

De weergegeven prijs is de adviesprijs in euro excl. BTW. Deze kan onderhevig zijn aan korting. Neem contact op met uw lokale distributeur of detailhandel voor de daadwerkelijke prijs

<b>beschermingsklasse tegen elektrische schokken</b>	Klasse II In overeenstemming met IEC 60536
<b>IP beschermingsgraad</b>	IP66 In overeenstemming met IEC 60529
<b>Enclosure Type</b>	UL type 4X/13
<b>weerstand hoge druk drukring</b>	7000000 Pa om 55 °C, afstand: 0.1 m
<b>IK-beschermingsgraad</b>	IK03 In overeenstemming met IEC 50102
<b>standards</b>	IEC 60947-5-5 JIS C8201-5-1 IEC 60947-5-4 IEC 60947-5-1 IEC 60947-1 CSA C22.2 Nr 14 UL 508 JIS C8201-1
<b>product certifications</b>	DNV CSA BV LROS (Lloyds register of shipping) UL listed
<b>trilling bestendigheid</b>	5 gn (f= 2...500 Hz) In overeenstemming met IEC 60068-2-6
<b>schokbestendigheid</b>	30 gn (duur = 18 ms) voor halve sinusgolf versnelling In overeenstemming met IEC 60068-2-27 50 gn (duur = 11 ms) voor halve sinusgolf versnelling In overeenstemming met IEC 60068-2-27

## Verpakkingseenheid

<b>Eenheidstype van verpakking 1</b>	PCE
<b>Aantal eenheden in verpakking 1</b>	1
<b>verpakking 1 hoogte</b>	3,500 cm
<b>verpakking 1 breedte</b>	5,500 cm
<b>verpakking 1 lengte</b>	8,500 cm
<b>verpakking_1_gewicht</b>	76,200 g
<b>Eenheidstype van verpakking 2</b>	S02
<b>Aantal eenheden in verpakking 2</b>	50
<b>verpakking 2 hoogte</b>	15,000 cm
<b>verpakking 2 breedte</b>	30,000 cm
<b>verpakking 2 lengte</b>	40,000 cm
<b>verpakking 2 gewicht</b>	4,052 kg
<b>Eenheidstype van verpakking 3</b>	P06
<b>Aantal eenheden in verpakking 3</b>	800
<b>verpakking_3_hoogte</b>	75,000 cm
<b>verpakking 3 breedte</b>	80,000 cm
<b>verpakking 3 lengte</b>	60,000 cm
<b>verpakking 3 gewicht</b>	72,840 kg

## contractuele waarborg

<b>Garantie (in maanden)</b>	18
------------------------------	----

Schneider Electric wil tegen 2050 de Net Zero-status hebben bereikt via partnerschappen in de toeleveringsketen, materialen met een lagere impact en circulariteit via onze doorlopende campagne "Use Better, Use Longer, Use Again" om de levensduur van producten en de recycleerbaarheid te verlengen.

[Uitleg van Environmental Data >](#)

[Hoe evalueren we de duurzaamheid van producten? >](#)

### Milieuoetafdruk

Totale levenscyclus ecologische voetafdruk	0.7 kg CO2 eq.
Koolstofvoetafdruk van de fabricagefase [A1–A3]	0.5 kg CO2 eq.
Koolstofvoetafdruk van de distributiefase [A4]	0 kg CO2 eq.
Koolstofvoetafdruk van de installatiefase [A5]	0 kg CO2 eq.
Koolstofvoetafdruk van de gebruiksfase [B2, B3, B4, B6]	0 kg CO2 eq.
Koolstofvoetafdruk van de einde-levensfase [C1–C4]	0.1 kg CO2 eq.
Milieu Profiel	<a href="#">Milieuprofiel van het product</a>

## Use Better

### Materialen en verpakking

Pakket met gerecycleerd karton	Ja
Verpakkingen zonder kunststof	Ja
RoHS-richtlijn van de EU	<a href="#">Conform door vrijstelling</a>
REACH-verordening	<a href="#">Referentie bevat zorgwekkende stoffen (SVHC) boven drempelwaarde</a>

## Use Longer

### Levensduurverlenging

Reparatie	Nee
-----------	-----

## Use Again

### Herverpakken en herfabriceren

Percentage mogelijke recycleerbaarheid	23
Circulair Profiel	<a href="#">Informatie over einde levensduur</a>
Terugname	Ja

Dimensions Drawings

Dimensions

---

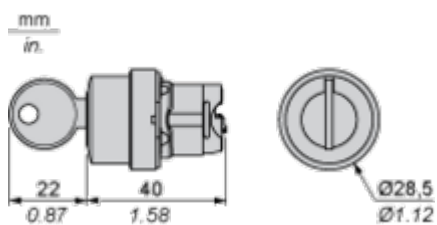

Mounting and Clearance

Panel Cut-out for Pushbuttons, Switches and Pilot Lights (Finished Holes, Ready for Installation)

Connection by Screw Clamp Terminals or Plug-in Connectors or on Printed Circuit Board



- (1) Diameter on finished panel or support
- (2) For selector switches and Emergency stop buttons, use of an anti-rotation plate type ZB5AZ902 is recommended.
- (3) Ø22.5 mm recommended ( $\text{Ø}22.3 \text{ }_0^{+0.4}$ ) / Ø0.89 in. recommended ( $\text{Ø}0.88 \text{ in. }_0^{+0.016}$ )

Connections	a in mm	a in in.	b in mm	b in in.
By screw clamp terminals or plug-in connector	40	1.57	30	1.18
By Faston connectors	45	1.77	32	1.26
On printed circuit board	30	1.18	30	1.18

Detail of Lug Recess

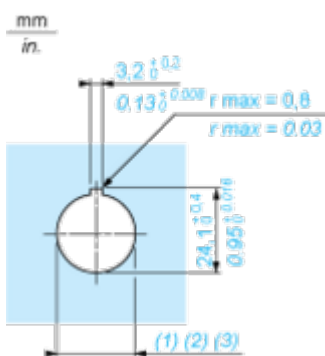

- (1) Diameter on finished panel or support
- (2) For selector switches and Emergency stop buttons, use of an anti-rotation plate type ZB5AZ902 is recommended.
- (3) Ø22.5 mm recommended ( $\text{Ø}22.3 \text{ }_0^{+0.4}$ ) / Ø0.89 in. recommended ( $\text{Ø}0.88 \text{ in. }_0^{+0.016}$ )





A: 1.18 in. min.  
 B: 1.57 in. min.

**General Tolerances of the Panel and Printed Circuit Board**

The cumulative tolerance must not exceed 0.3 mm / 0.012 in.: T1 + T2 = 0.3 mm max.

**Installation Precautions**

- Minimum thickness of circuit board: 1.6 mm / 0.06 in.
- Cut-out diameter: 22.4 mm ± 0.1 / 0.88 in. ± 0.004
- Orientation of body/fixing collar ZB5AZ009: ± 2° 30' (excluding cut-outs marked a and b).
- Tightening torque of screws ZBZ006: 0.6 N.m (5.3 lbf.in) max.
- Allow for one ZB5AZ079 fixing collar/pillar and its fixing screws:
  - every 90 mm / 3.54 in. horizontally (X), and 120 mm / 4.72 in. vertically (Y).
  - with each selector switch head (ZB5AD\*, ZB5AJ\*, ZB5AG\*).

The fixing centers marked a and b are diagonally opposed and must align with those marked 4 and 5.



- (1) Head ZB5AD•
- (2) Panel
- (2) Nut
- (4) Printed circuit board

## Mounting of Adapter (Socket) ZBZ01•

- 1 2 elongated holes for ZBZ006 screw access
- 2 1 hole  $\varnothing$  2.4 mm  $\pm$  0.05 / 0.09 in.  $\pm$  0.002 for centring adapter ZBZ01•
- 3 8  $\times$   $\varnothing$  1.2 mm / 0.05 in. holes
- 4 1 hole  $\varnothing$  2.9 mm  $\pm$  0.05 / 0.11 in.  $\pm$  0.002, for aligning the printed circuit board (with cut-out marked **a**)
- 5 1 elongated hole for aligning the printed circuit board (with cut-out marked **b**)
- 6 4 holes  $\varnothing$  2.4 mm / 0.09 in. for clipping in adapter ZBZ01•

Dimensions An + 18.1 relate to the  $\varnothing$  2.4 mm  $\pm$  0.05 / 0.09 in.  $\pm$  0.002 holes for centring adapter ZBZ01•.

Technical Description

Electrical Composition Corresponding to Code C12

---

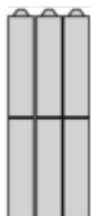

Electrical Composition Corresponding to Code C13

---



Electrical Composition Corresponding to Code C15

---

1 N/O

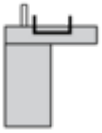

1 N/C

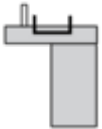

1 N/O + N/C or 1 N/O + N/O or 1 N/C + N/C

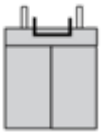

Electrical Composition Corresponding to Codes C9, C11, SF1 and SR1



**Legend**

---

Single contact



Double contact



Light block



Possible location



Technical Illustration

Dimensions

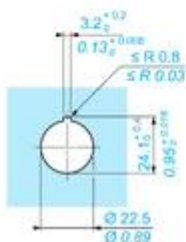
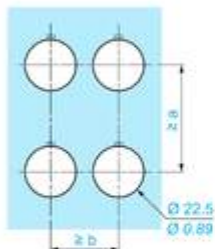
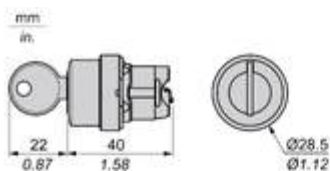

		a (mm)	a (in.)	b (mm)	b (in.)
		40	1.57	30	1.18
ZBE●●●●●	ZBV●●●●●				
		45	1.77	32	1.26
ZBE●●●●●3	ZBV●●●●●3				
		40	1.57	30	1.18
ZBE●●●●●4	ZBV●●●●●4				
		50	1.97	30	1.18
ZBE●●●●●5	ZBV●●●●●5				
		40	1.57	30	1.18
ZBE●●●●●9	ZBV●●●●●9				
		40	1.57	30	1.18
ZBRT●	ZBRV1				